

The 4th Workshop on GHG Inventories in Asia (WGIA)
14-15 February 2007, Jakarta, Indonesia

**SHORT- TERM AND LONG- TERM INVENTORY
STRATEGIES OF MONGOLIA**

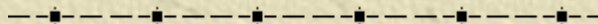
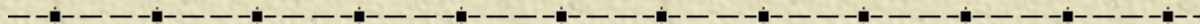

Batimaa P. Institute of Meteorology and Hydrology

Contents

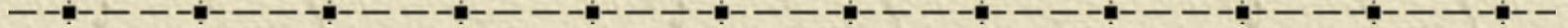

 **Introduction**

 **Short term inventory strategy**

 **Long term inventory strategy**



Introduction

-
- ✦ Mongolia has prepared its first greenhouse gases (GHG) inventory in 1996 for the base year 1990 under the US Country Studies Programme
 - ✦ The inventory has been updated within the Asia Least-Cost Greenhouse Gas Abatement Strategy (ALGAS) in 1997.
 - ✦ Initial National Communication (GEF/ UNEP), the GHG inventories were updated to 1998 with base year 1994.
 - ✦ Capacity Building for Improving GHG Inventories

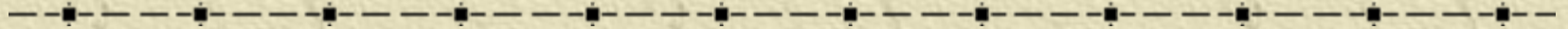
Introduction



The main goals of these strategies:

-  to determine and prioritize the key needs for the preparation of the GHG emission inventories and
-  to identify ways for improving methods and procedures for future inventories

Introduction

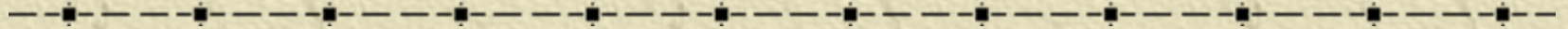

Barriers

- ✦ No standard data for inventory
- ✦ No system in data collection and checking
- ✦ No Institutional framework

Short term inventory strategy

Data collection and archiving

- ✦ prepare a list of identified data gaps
- ✦ develop a national procedures of Activity data (AD) collection
- ✦ include necessary data for GHG inventories in Statistical Yearbook
- ✦ design of the database structure of national AD and Emission factors (EFs)
- ✦ **establish National AD and EFs Database**

Data and EF assessment

No	Sector	Activity data necessary for GHG inventory	Data source	Barriers to find activity data	How to overcome the barrier
5	Waste				
	Landfills	Urban population	Statistical year book		
	Domestic wastewater	Urban population	Statistical year book		
	Commercial and industrial wastewater	Annual wastewater	Annual Water usage Report of Water management Institute	This annual report is not available from library.	There are necessary official documentation to include in Annual report on environmental issues of Ministry of nature and Environment.

Solid waste

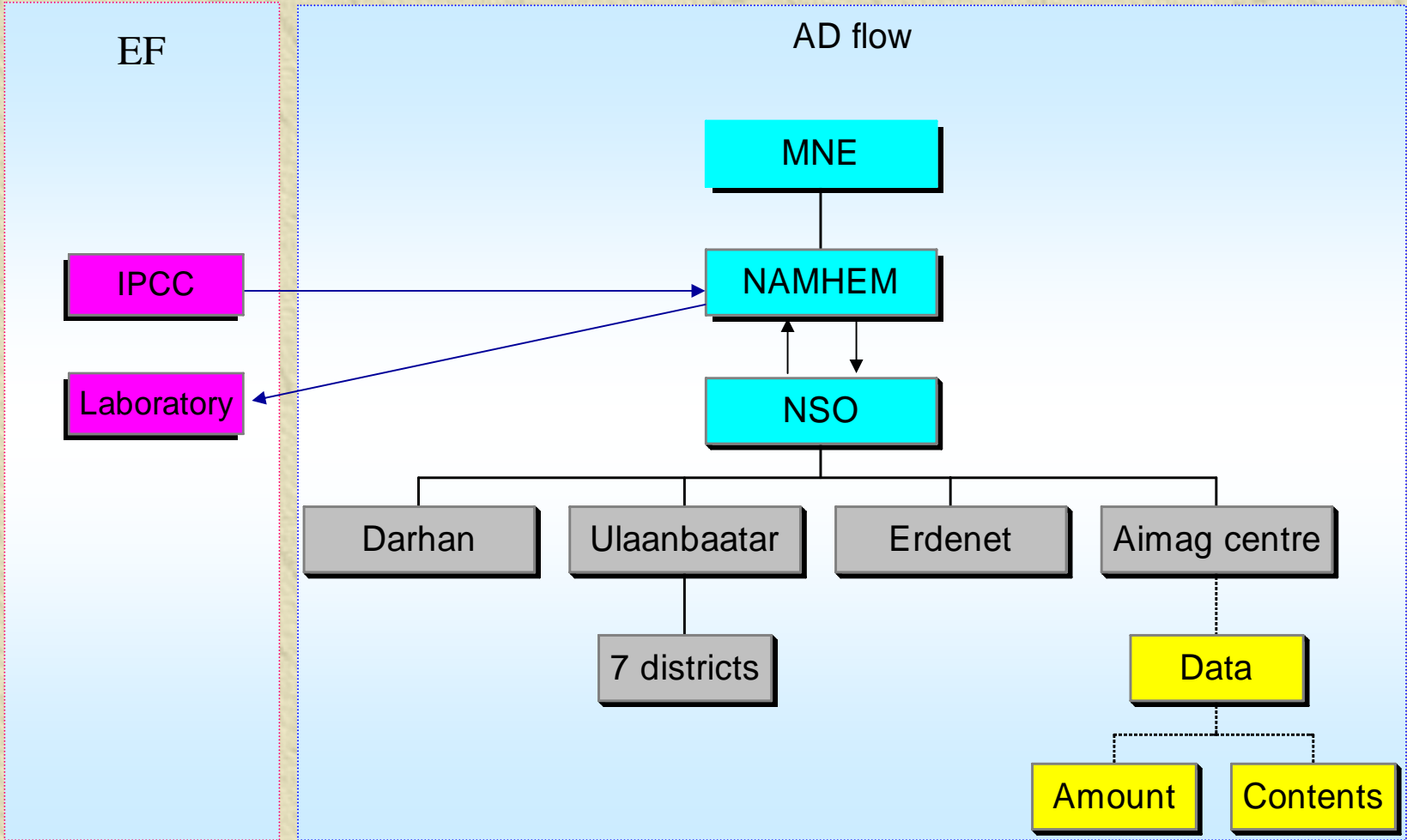
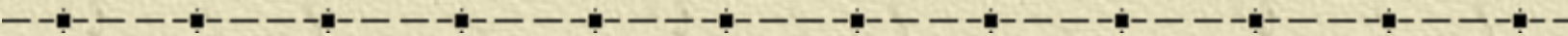

Mobile

EF

AD flow

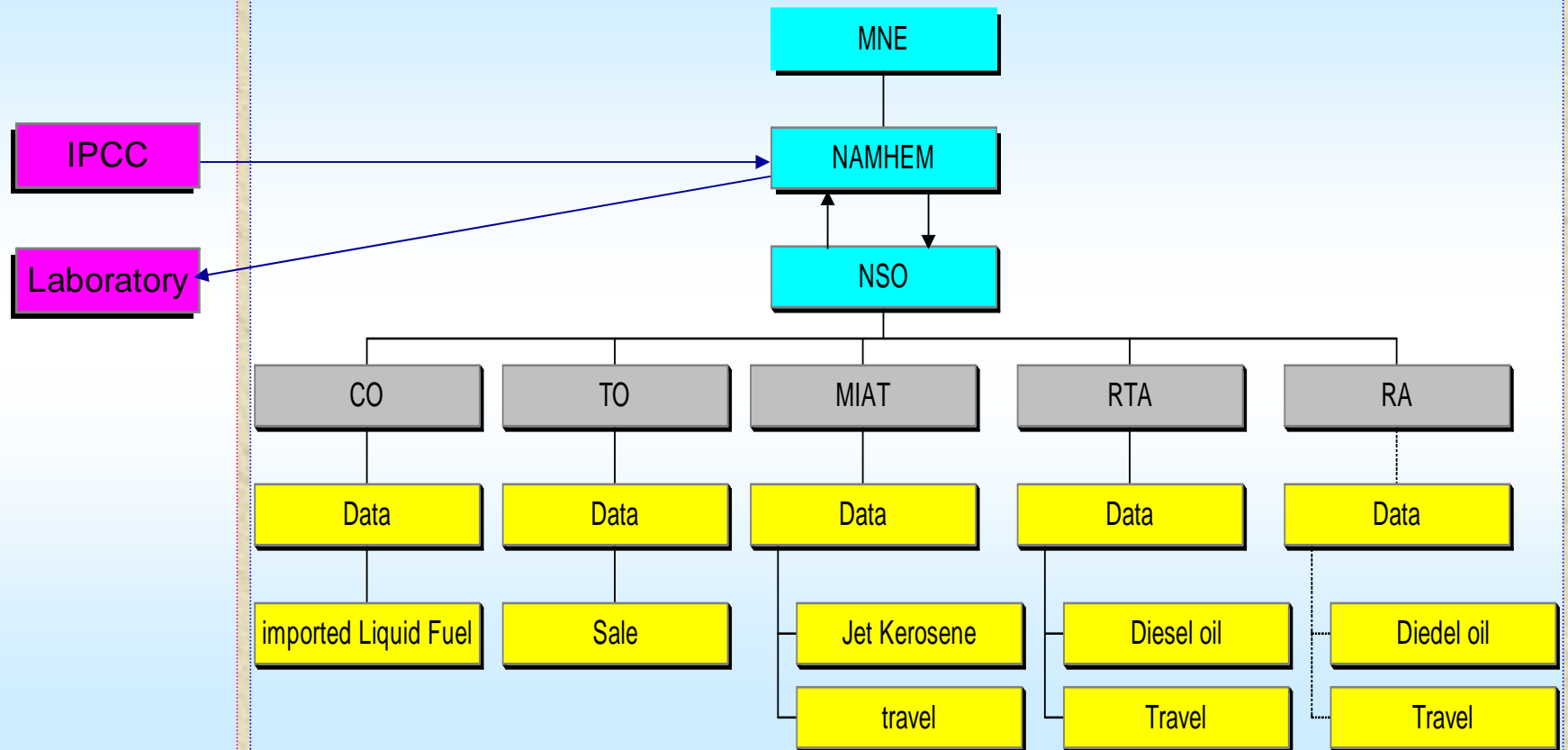

Short term inventory strategy

Improvement of Emission Factors

- ✦ develop a list of emission factors used in GHG inventories
- ✦ check reliability of EFs used
- ✦ prepare a list of local emission factors to be estimated in the specific local conditions
- ✦ estimate local EFs

Completeness

- ✦ identify missing sub -sectors and emission gases in the GHG inventories
- ✦ develop a work plan for national inventory by using IPCC Good practice Guidance

Short term inventory strategy

Methodological issues

- ✦ prepare national manual for preparation of national GHG inventories
- ✦ learn IPCC Good Practice and Uncertainty Management in National GHG Inventories

Inventory quality and uncertainty assessment



- ✦ prepare quality assurance and quality control (QA/ QC) plan in the development of national GHG inventories
- ✦ assess uncertainties

Reporting and Documentation

- ✦ create reporting and documentation system for national GHG inventory

Long Term strategy (2007- 2010)

Data

-  **To improve the design of the database structure of national AD and EFs**
-  **To develop a national guidance for updating national and/ or activity data of sectors**
-  **To establish database of National AD and EFs**



Long Term strategy (2007- 2010)

Emission factors

- ✦ To check reliability of EFs used
- ✦ To check estimated local EFs

Long Term strategy (2007- 2010)

Completeness

-  **To conduct key source analysis of the GHG inventories**
-  **To identify missing sub- sectors and activities in the GHG inventories**
-  **To estimate emissions of missed gases**

Long Term strategy (2007- 2010)

Institutional and procedural arrangements

- ✦ To establish a legal instrument on data issuing for GHG**
- ✦ To establish an institutional structure for preparation of national GHG inventories**
- ✦ To develop a capacity building program**
- ✦ To establish a permanent center/ laboratory/ team of experts responsible for preparation of national GHG inventories**

Long Term strategy (2007- 2010)

Inventory quality and uncertainty assessment

- ✦ To establish an official technical peer review process**
- ✦ To conduct inventories QA/ QC**

Long Term strategy (2007- 2010)

Reporting and Documentation

- ✦ To create inventory documentation system**
- ✦ To complete documentation of activity data, EFs, methods**
- ✦ To conduct trend analyses**
- ✦ To conduct recalculations**

Thank you

