

国立公害研究所研究報告 第11号

Research Report from the National Institute for Environmental Studies NO. 11, 1980.

R-11-'80

*Studies on the Effects of  
Air Pollutants on Plants  
and  
Mechanisms of Phytotoxicity*

NIES

THE NATIONAL INSTITUTE FOR ENVIRONMENTAL STUDIES

環境庁 国立公害研究所

## ERRATA

Research Report from The National Institute for Environmental Studies NO. 11

Studies on the Effects of Air Pollutants on Plants and Mechanisms of Phytotoxicity

Page	Line	Read	Corrected
Preface	3	paticular	particular
	9	Phytotoron	Phytotron
Contents	No. 6	atmospheric	atmospheric
	No. 12	traspiration	transpiration
	No. 24	surfur	sulfur
30	Ref. 7	No. 11: 9-17 (1980).	No. 10: 139-158 (1979).
69	3*	lammellae	lamellae
89	Ref. 31	Zieler	Ziegler
103	Abstract 18	and which allowed	and allowed
105	10*	Beforre	Before
105	6*	663 mm	663 nm
108	12	omplex	complex
108	Fig. 5 legend	$\alpha$ -protain	$\alpha$ -protein
109	3	$\ominus$ -protein	$\alpha$ -protein
111	1*	paticular	particular
112	Ref. 3	abscidic	abscisic
112	Ref. 17	SO <sub>3</sub> <sup>-</sup>	SO <sub>3</sub> <sup>-</sup>
113	14*	(24, 25)	(25, 26)
114	7	(25)	(26)
116	1	(21)	(22)
118	20	(22)	(23)
118	8*	However	And
118	8*	could not find	could find
122	13*	(1, 23)	(1, 24)
122	12*	(25)	(26)
122	10*	However, we	We
123	3*	(25)	(26)
124	10*	(6, 21)	(6, 22)
140	Table 1	<i>Pieris japonia</i>	<i>Pieris japonica</i>
153	Fig. 2 legend	10 Mm Na <sub>2</sub> SO <sub>3</sub>	10 mM Na <sub>2</sub> SO <sub>3</sub>
158	Fig. 1 B legend	fumination.	fumigation.
168	Table 1	Persoxisomes	Peroxisomes
169	Fig. 4	Left figure is (A) and light one is (B).	
186	6	$\Delta T = -L / (8\sigma T_a^3 + 2h_T) \} W$	$\Delta T = -\{L / (8\sigma T_a^3 + 2h_T) \} W$
187	Fig. 4 legend	SO <sub>2</sub> sorption rate divided	SO <sub>2</sub> sorption rate to transpiration rate divided
206	15	(1 - $\Delta P / \Delta U_{max}$ )	(1 - $\Delta \bar{P} / \Delta U_{max}$ )
222	Table 1 legend	NC <sub>2</sub>	NO <sub>2</sub>
229	10*	0.25	2.5

\* from bottom

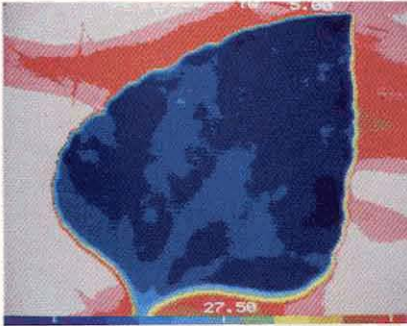

0 min

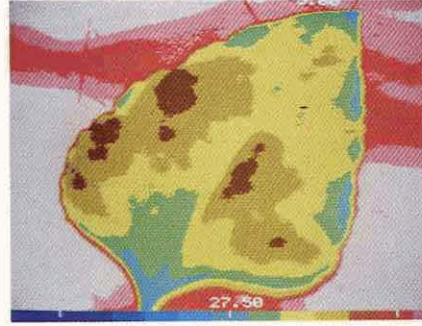

60 min

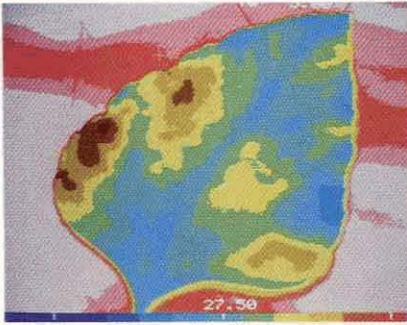

20 min

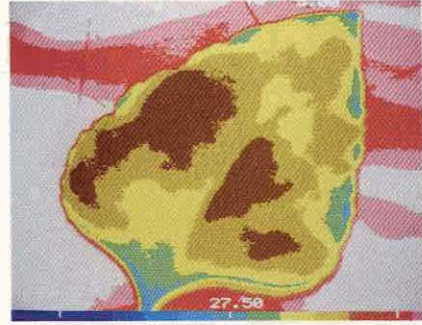

80 min

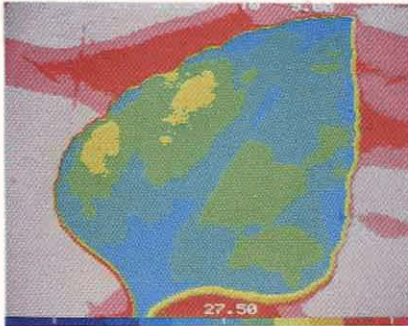

40 min

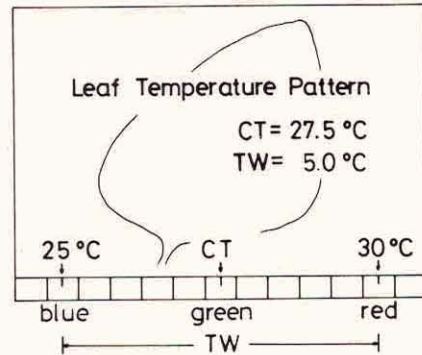

*An example of the changes in thermal pattern of sunflower leaf during SO<sub>2</sub> fumigation. Numerals under the pictures show time in minutes after starting the fumigation. An image processing system and experimental conditions were described in this Report p. 239-247.*

## Preface

As a result of rapid growing industrialization and motorization in many urban areas, it is increasingly being recognized that substances harmful to the plant and animal kingdom are being released into the environment as air pollutants. In particular, much attention has been given to the toxic effects of sulfur dioxide on man and plants. More recently, oxides of nitrogen and photochemical smog have also attracted much attention.

In this connection, the National Institute for Environmental Studies initiated in 1976 a special research program designated "Studies on Evaluation and Amelioration of Air Pollution by Plants" as one of its major research projects. A specially designed facility, the Phytotron, equipped with plant exposure chambers, was constructed for the study. During the first three years, efforts have concentrated mainly on accumulating basic data on the effects of sulfur dioxide and nitrogen dioxide on certain plant species. Such effects have been studied from the macroscopic and microscopic view points by researchers from the physiological, biochemical, ecological and micrometeorological fields.

This report covers the results obtained during the initial three year period by the various groups of workers engaged in the project. We hope that the results will stimulate discussion among workers in environmental research fields and that the report can contribute to the promotion of environmental science throughout the world.

The second three year program commenced in 1979 and the study is principally concerned with the effects of mixed air-borne pollutants on higher plants. It is hoped that useful suggestions and collaborations from the related research fields will be given to this study.

Manabu Sasa, M.D.

Director of the National Institute for  
Environmental Studies

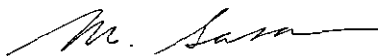

January 1980

# CONTENTS

## Preface

M. Sasa

### Effects of sulfur dioxide on photosynthesis and growth of plants

1. The effect of SO<sub>2</sub> on net photosynthesis in sunflower leaf ..... 1  
A. Furukawa, T. Natori and T. Totsuka
2. Effects of low concentrations of SO<sub>2</sub> on the growth of sunflower ..... 9  
H. Shimizu, A. Furukawa and T. Totsuka
3. A model for estimating SO<sub>2</sub> effects on canopy photosynthesis in sunflower plants ..... 19  
T. Totsuka

### Absorption of atmospheric NO<sub>2</sub> by plants

4. Absorption of atmospheric NO<sub>2</sub> by plants and soils V . Day and night NO<sub>2</sub>-fumigation effect on the plant growth and estimation of the amount of NO<sub>2</sub>-nitrogen absorbed by plants ..... 31  
T. Yoneyama, T. Totsuka, N. Hayakawa and J. Yazaki
5. Absorption of atmospheric NO<sub>2</sub> by plants and soils VI . Transformation of NO<sub>2</sub> absorbed in the leaves and transfer of the nitrogen through the plants ..... 51  
M. Kaji, T. Yoneyama, T. Totsuka and H. Iwaki
6. Absorption of atmospheric NO<sub>2</sub> by plants and soils VII . NO<sub>2</sub> absorption by plants: re-evaluation of the air-soil-root route ..... 59  
T. Yoneyama, T. Yasuda, J. Yazaki and T. Totsuka

### Mechanisms of sulfur dioxide phytotoxicity

7. Specific inhibition of photosystem II activity in chloroplasts by fumigation of spinach leaves with SO<sub>2</sub> ..... 69  
K. Shimazaki and K. Sugahara
8. Inhibition site in electron transport system in chloroplasts by fumigation of lettuce leaves with SO<sub>2</sub> ..... 79  
K. Shimazaki and K. Sugahara
9. Active oxygen participation in chlorophyll destruction and lipid peroxidation in SO<sub>2</sub>-fumigated leaves of spinach ..... 91  
K. Shimazaki, T. Sakaki and K. Sugahara
10. Effects of sulfite ions on water-soluble chlorophyll proteins ..... 103  
K. Sugahara, S. Uchida and M. Takimoto

### Mechanisms of resistance to sulfur dioxide in plants

11. Interspecific difference in resistance to sulfur dioxide ..... 113  
A. Furukawa, O. Isoda, H. Iwaki and T. Totsuka
12. Abscisic acid-dependent changes in transpiration rate with SO<sub>2</sub>  
fumigation and the effects of sulfite and pH on stomatal  
aperture ..... 127  
N. Kondo, I. Maruta and K. Sugahara
13. Sulfite oxidizing activities in plants ..... 137  
N. Kondo, Y. Akiyama, M. Fujiwara and K. Sugahara
14. Resistance of spruce seedlings to sulfur dioxide fumigation ..... 151  
T. Oku, K. Shimazaki and K. Sugahara
15. Role of superoxide dismutase in the defense against SO<sub>2</sub> toxicity  
and induction of superoxide dismutase with SO<sub>2</sub> fumigation ..... 155  
K. Tanaka and K. Sugahara
16. Formation and scavenging of superoxide in chloroplasts, with relation to  
injury by sulfur dioxide ..... 165  
K. Asada

### Analysis of air pollutant sorption by plants

17. Analysis of air pollutant sorption by plants (1). Relation between  
local SO<sub>2</sub> sorption and acute visible leaf injury ..... 181  
K. Omasa and F. Abo
18. Analysis of air pollutant sorption by plants (2). A method for  
simultaneous measurement of NO<sub>2</sub> and O<sub>3</sub> sorptions by plants  
in environmental control chamber ..... 195  
K. Omasa, F. Abo, S. Funada and I. Aiga
19. Analysis of air pollutant sorption by plants (3). Sorption under  
fumigation with NO<sub>2</sub>, O<sub>3</sub> or NO<sub>2</sub> + O<sub>3</sub> ..... 213  
K. Omasa, F. Abo, T. Natori and T. Totsuka

### Evaluation of air pollution injury by pattern analysis

20. Remote sensing of the physiological functions of plants by  
infrared color aerial photography (I). Relations between leaf  
reflectivity ratio, bi-band ratio and photosynthetic function of  
leaves in several woody plants ..... 225  
M. Aoki, K. Yabuki and T. Totsuka
21. Measurement of the thermal pattern of plant leaves under  
fumigation with air pollutant ..... 239  
K. Omasa, F. Abo, Y. Hashimoto and I. Aiga
22. Evaluation of air pollution injury to plants by image processing ..... 249  
K. Omasa, F. Abo, Y. Hashimoto and I. Aiga

**Screening of indicator plants for  
air pollution**

23. Selected rice (*Oryza sativa* L.) strains as an indicator plant  
for air pollution ..... 255  
    Y. Fujinuma and I. Aiga
24. Inheritance of sensitivity to sulfur dioxide in rice,  
*Oryza sativa* L. .... 263  
    T. Omura, H. Satoh, Y. Fujinuma and I. Aiga

## The effect of SO<sub>2</sub> on net photosynthesis in sunflower leaf

Akio Furukawa, Toshiki Natori and Tsumugu Totsuka

Division of Environmental Biology, The National Institute for Environmental Studies,  
Yatabe, Ibaraki 305

The rate of CO<sub>2</sub> exchange in the light and the dark was investigated in attached leaves of sunflower (*Helianthus annuus* L. cv. Russian Mammoth) in the assimilation chamber during SO<sub>2</sub> exposure. Relative humidity was maintained at 50 – 60 % and leaf temperature was 25–27°C. The rate of net photosynthesis was reduced to 25 % of the pretreatment rate after 30 min exposure to 1.5 ppm SO<sub>2</sub>. The rate of photorespiration was determined from the difference between the rate of CO<sub>2</sub> exchange at 20 % O<sub>2</sub> and at 2 % O<sub>2</sub>. When the rate of net photosynthesis was completely inhibited, the rate of photorespiration was also completely inhibited. Furthermore the rate of CO<sub>2</sub> evolution into CO<sub>2</sub>-free air in the light was reduced to the level of dark respiration by the exposure to 1.5 ppm SO<sub>2</sub>. This result suggests that photorespiration was inhibited by SO<sub>2</sub>. The resistance of CO<sub>2</sub> diffusion through boundary layer and stomata slightly increased from 4 sec/cm to 5 sec/cm during the initial 30 min of SO<sub>2</sub> exposure. On the other hand, the rate of dark respiration was not affected by SO<sub>2</sub>. From these results, we concluded that SO<sub>2</sub> decreased the gross photosynthesis of sunflower leaves through a breakdown of the chloroplasts.

**Key words:** Sulfur dioxide – Net photosynthesis – Sunflower plant – Photorespiration – CO<sub>2</sub> concentration

It has been recognized that SO<sub>2</sub> is the most widespread air pollutant, and the effects of SO<sub>2</sub> on vegetation have been studied more than those of other major gaseous pollutants (7). Many workers have reported about the effects of SO<sub>2</sub> on net photosynthesis (8, 10, 15). However, main factors which contribute to the reduction of net photosynthesis by SO<sub>2</sub> are obscure.

In the present report, we compared the effects of stomatal closure and chloroplast activity on photosynthetic response to SO<sub>2</sub>. The rate of photosynthesis in C<sub>3</sub> plants depends primarily on stomatal aperture, chloroplast activity for CO<sub>2</sub> fixation, and mitochondrial and/or peroxisomal activity for CO<sub>2</sub> evolution. Recently Shimazaki and Sugahara (9) have shown that chloroplast activity, measured as oxygen evolution in the presence of 2,6-dichloroindophenol as an electron acceptor, is inhibited when chloroplasts are isolated from spinach leaves exposed to 2.0 ppm SO<sub>2</sub>. They have also shown that the inhibition of chloroplast activity parallels that occurring when photosynthesis is measured as oxygen evolution from leaf slices dipped into water. However, Sij and Swanson (10), and Ohshima et al. (8) showed that the rate of transpiration, an indirect indicator of stomatal aperture, was reduced by the exposure to SO<sub>2</sub>. Furthermore, Taniyama et al. (14) showed an increase in the rate of dark respiration



when rice plants were exposed to 1–2 ppm SO<sub>2</sub> for 4 hr. Thus, from these data, it was not possible to distinguish whether stomatal closure, chloroplast activity or mitochondrial activity limited photosynthesis during the exposure to SO<sub>2</sub>.

The rate of net photosynthesis is considered to be limited by either the diffusive resistance to CO<sub>2</sub> entry into the leaf intercellular space through the boundary layer adjacent to the leaf surface and through the stomatal cavity or the activity of chloroplast for the carboxylation associated with CO<sub>2</sub> fixation. For limitation due to CO<sub>2</sub> diffusion, the rate of net photosynthesis (P) is represented by:

$$P = \frac{C_a - C_i}{R_a + R_s}$$

where C<sub>a</sub> is the CO<sub>2</sub> concentration of the bulk air and C<sub>i</sub> is the CO<sub>2</sub> concentration in the intercellular leaf spaces, R<sub>a</sub> and R<sub>s</sub> are boundary layer and stomatal resistances for CO<sub>2</sub> diffusion. According to the above equation, if the inhibition of photosynthesis by SO<sub>2</sub> is associated with an increased diffusion resistance for CO<sub>2</sub> then inhibition of net photosynthesis is due primarily to stomatal closure. This approach was used in the present work to determine the main factor affecting the photosynthetic inhibition caused by SO<sub>2</sub>.

#### Materials and methods

Sunflower plants (*Helianthus annuus* L. cv. Russian Mammoth) were grown for 4 to 5 weeks in a phytotron greenhouse at 25°C and 75 % relative humidity in plastic pots (11cm in diameter) containing peat moss, vermiculite, perlite, and fine gravel (2:2:1:1 v/v). Environmental conditions in a greenhouse were as follows; air temperature 25°C and relative humidity 75 %. The attached leaves were placed in an assimilation chamber. The acrylic assimilation chamber was 30 cm long, 17.5 cm wide, and 2 cm deep. The chamber was conditioned for 25–27°C leaf temperature, 50–60 % relative humidity, and 30 klx of light intensity. The CO<sub>2</sub> concentration was controlled by mixing CO<sub>2</sub>-free air with CO<sub>2</sub> from a cylinder. CO<sub>2</sub>-free air was prepared by passing air through tubes filled with soda lime. When photorespiration was measured, the CO<sub>2</sub> and O<sub>2</sub> concentrations were regulated by mixing N<sub>2</sub> with CO<sub>2</sub> and O<sub>2</sub> from cylinders. Air at the desired concentration of CO<sub>2</sub> was passed in succession through a humidity controller and through a coiled glass tube placed in the water bath. Water temperature in the bath was controlled using a Thomas thermo-regulator. SO<sub>2</sub> from a compressed cylinder containing 1,000 ppm SO<sub>2</sub> in N<sub>2</sub> was injected through a thermal mass-flow controller into the air stream before it entered the chamber. The concentrations of SO<sub>2</sub> and CO<sub>2</sub> in the air entering and leaving the chamber were simultaneously measured. The conventional method was applied for the determination of the rate of net photosynthesis (2). The concentration of CO<sub>2</sub> in the air was measured using an infrared CO<sub>2</sub> analyzer (Fuji Electric Co., Model ZAP). SO<sub>2</sub> concentration was monitored by a flame photometric detector of SO<sub>2</sub> (Bendix, Model 830). The water vapor contents of the air entering and leaving the assimilation chamber were measured by wet and dry bulb thermocouple psychrometers which were calibrated routinely, and the transpiration rate was calculated from the difference between the water vapor concentrations in the inlet and the outlet of the chamber. Leaf temperature was measured with three copper-constantan thermocouples attached to the underside of the leaf surface. The rate of air flow through the assimilation chamber was maintained at 10 liter·min<sup>-1</sup>. When dark respiration was measured, the flow rate was adjusted to 5 liter·min<sup>-1</sup>. Incident light beams were provided

## Effects of SO<sub>2</sub> on net photosynthesis of sunflower

by means of two 500 W incandescent lamps and were filtered through water filter of 10 cm in depth to absorb heat radiation. A semitransparent film made of vinyl was interposed between the water filter and the assimilation chamber to get uniform distribution of light intensity. This provided a light intensity of 30 klx, measured with Lambda photometer, inside the chamber. An intact leaf of sunflower was placed in the assimilation chamber and pre-illuminated for more than an hour to get the steady state of photosynthetic CO<sub>2</sub> uptake level before SO<sub>2</sub> exposure.

### Results

We studied the effects of SO<sub>2</sub> on the rate of net photosynthesis, photorespiration, dark respiration, the gas phase diffusion resistance of CO<sub>2</sub>, and the CO<sub>2</sub> compensation point of sunflower leaves.

Fig. 1 shows the response of net photosynthesis and transpiration in sunflower during the exposure to 1.5 ppm SO<sub>2</sub> for 1 hr. Inhibition of photosynthesis was initially rapid with a more gradual, but steady, decrease during the remainder of the exposure period. After introducing SO<sub>2</sub>, photosynthesis rapidly decreased to 25 % of the pretreatment rate within the first 30 min of exposure. The rate of transpiration during the exposure to the same SO<sub>2</sub> concentration decreased slightly.

Fig. 2 shows that the diffusion resistance was increased slightly just after the initiation of SO<sub>2</sub> exposure. The diffusion resistance to CO<sub>2</sub> transfer through boundary layer and stomata was calculated from the data presented in Fig. 1. The diffusion resistance can be divided into two parts. One is the boundary layer resistance, the other is stomatal resistance. The boundary layer resistance was held constant during the exposure of SO<sub>2</sub> by the constant flowing of the air and the same size and shape of the leaf. As a result, changing diffusion resistance was primarily due to changing in stomatal resistance. Therefore, we regard the changes of the diffusion resistance shown in Fig. 2 as the

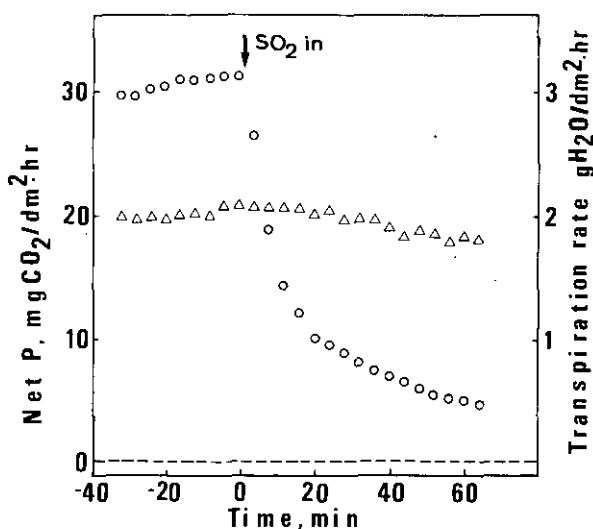

Fig. 1. Net photosynthetic rate and transpiration rate of sunflower leaf treated with 1.5 ppm SO<sub>2</sub> for 1 hour.

changes of stomatal resistance.

The effects of a 1-hour exposure to 1.5 ppm  $\text{SO}_2$  on dark respiration are shown in Fig. 3. The rate of dark respiration prior to  $\text{SO}_2$  treatment was  $1.4 \text{ mgCO}_2/\text{dm}^2 \cdot \text{hr}$ . After 1-hr exposure to 1.5 ppm  $\text{SO}_2$ , the rate of net photosynthesis was decreased from  $31.0 \text{ mgCO}_2/\text{dm}^2 \cdot \text{hr}$ , to  $5.0 \text{ mgCO}_2/\text{dm}^2 \cdot \text{hr}$ , but the rate of dark respiration was not changed by the identical concentration of  $\text{SO}_2$  and the duration of exposure.

Photorespiration and photosynthesis occur simultaneously in the light, and the accurate measurement of the rate of photorespiration in leaves using the  $\text{CO}_2$  exchange

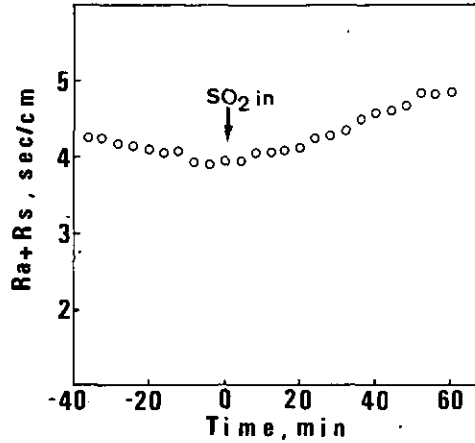

Fig. 2. Diffusion resistance of sunflower leaf. Data were calculated from the data presented in Fig. 1.

Ra; boundary layer resistance

Rs; stomatal resistance

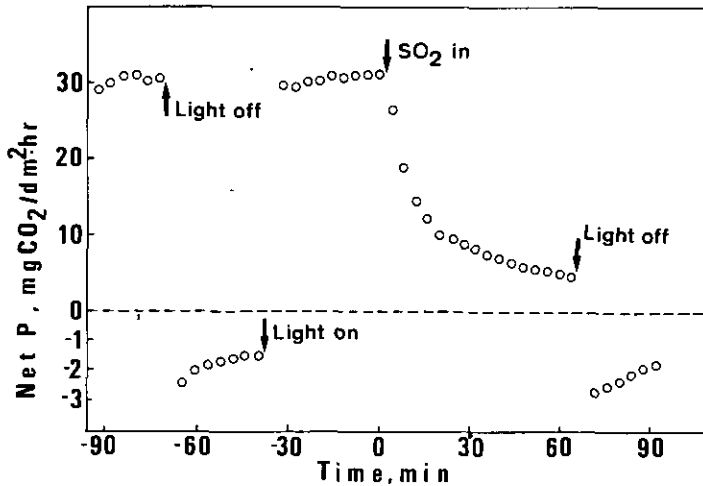

Fig. 3. The effect of exposure to 1.5 ppm  $\text{SO}_2$  on dark respiration of sunflower leaf.

method is extremely difficult. Therefore, two methods were applied to determine the effects of  $\text{SO}_2$  on photorespiration. One method was to measure the rates of  $\text{CO}_2$  uptake at 20%  $\text{O}_2$  and 2%  $\text{O}_2$  (16), another was to measure the  $\text{CO}_2$  evolution into  $\text{CO}_2$ -free air in the light.

Fig. 4 shows the rate of  $\text{CO}_2$  uptake at 20%  $\text{O}_2$  and 2%  $\text{O}_2$ . Before the exposure to  $\text{SO}_2$ , the difference between the rate of  $\text{CO}_2$  exchange at 20%  $\text{O}_2$  and that at 2%  $\text{O}_2$ , designated as photorespiration rate, was  $17.1 \text{ mgCO}_2/\text{dm}^2 \cdot \text{hr}$ . However, when net photosynthesis was completely inhibited, the difference could not be recognized. From

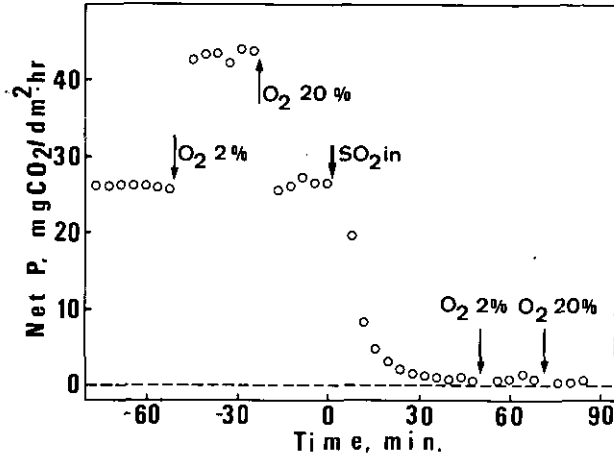

Fig. 4. The effect of 1.5 ppm  $\text{SO}_2$  on photorespiration rate. Photorespiration rate was designated as the difference between the rate of net photosynthesis at 20%  $\text{O}_2$  and that at 2%  $\text{O}_2$ .

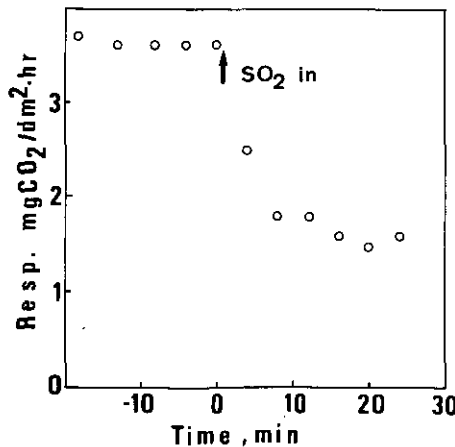

Fig. 5. The effect of 1.5 ppm  $\text{SO}_2$  on the rate of  $\text{CO}_2$  release into  $\text{CO}_2$ -free air in the light.

this result, we thought that photorespiration might be inhibited by  $\text{SO}_2$  exposure.

Fig. 5 shows that the rate of  $\text{CO}_2$  release into  $\text{CO}_2$ -free air in the light decreased from  $3.6 \text{ mgCO}_2/\text{dm}^2 \cdot \text{hr}$  of the pretreatment rate to  $1.5 \text{ mgCO}_2/\text{dm}^2 \cdot \text{hr}$ , dark respiration level, by 30 min exposure to  $1.5 \text{ ppm SO}_2$ . From these results shown in Fig. 4 and 5, we concluded that photorespiration was inhibited by  $\text{SO}_2$  exposure.

To demonstrate the effects of  $\text{SO}_2$  on the  $\text{CO}_2$  compensation point, the rate of net photosynthesis was measured at two  $\text{CO}_2$  concentrations before and after  $\text{SO}_2$  exposure. From the relation between the net  $\text{CO}_2$  uptake rate and the  $\text{CO}_2$  concentration, we determined the  $\text{CO}_2$  compensation point, where there is no net  $\text{CO}_2$  exchange. Fig. 6 shows the increase in the  $\text{CO}_2$  compensation point by  $\text{SO}_2$  exposure. During the pretreatment period, the  $\text{CO}_2$  compensation point was below  $54 \text{ ppm}$ . The exposure to  $1.5 \text{ ppm SO}_2$  at  $112 \text{ ppm CO}_2$  reduced the rate of net photosynthesis. After the exposure, we measured the rate of net photosynthesis at  $81 \text{ ppm CO}_2$  and the  $\text{CO}_2$  compensation point was determined. The  $\text{CO}_2$  compensation point thus estimated was above  $81 \text{ ppm}$  after  $1.5 \text{ hr}$  exposure.

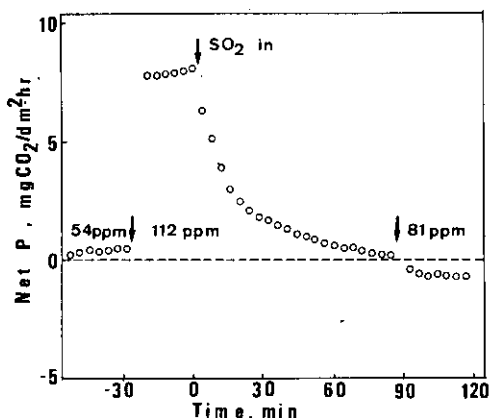

Fig. 6. The effect of  $1.5 \text{ ppm SO}_2$  on net photosynthetic rate to measure the  $\text{CO}_2$  compensation point. Numerals in the figure are the  $\text{CO}_2$  concentration of the air around the leaf.

### Discussion

It has been well documented that photosynthesis is a very sensitive physiological process in response to  $\text{SO}_2$  (6). The present result also shows that net photosynthesis is inhibited by  $\text{SO}_2$  exposure (Fig. 1). However, the mechanism which determines the reduction of net photosynthesis caused by  $\text{SO}_2$  is obscure. By the exposure to  $\text{SO}_2$ , the levels of metabolic intermediates may change (1, 6, 12), photosynthetic electron transport is inhibited (9), and rates of respiration in the light or in the dark may increase or decrease (8, 10, 14). Hence the primary purpose of the present research is to determine the main factor which contributes the reduction of net photosynthesis caused by  $\text{SO}_2$  exposure.

From the simultaneous observations of photosynthesis and transpiration (potometric water uptake experiments using cut leaves of pinto bean), Sij and Swanson (10) speculated that stomatal closure could not account for the reduction of photosynthesis caused by  $\text{SO}_2$  exposure. However, their suggestion was not based on direct estimation of the stomatal diffusion resistance but on observations of transpiration rate during  $\text{SO}_2$

exposure. Although transpiration rate is an indirect estimate of stomatal aperture, the degree of stomatal closure may be underestimated. Stomatal closure should induce an increase in leaf temperature, resulting in an increase in transpiration rate. Therefore, we determined the gas phase diffusion resistance to clarify the contribution of stomatal closure to the reduction of net photosynthesis. The present results (Fig. 2) suggest that the diffusion resistance was increased slightly immediately after the initiation of SO<sub>2</sub> exposure. During this same period, the rate of net photosynthesis decreased to 25 % of the pre-treatment rate. From these results, we conclude that stomatal closure was not a major factor contributing the SO<sub>2</sub>-induced reduction of photosynthesis in sunflower.

Change in dark respiration of sunflower did not contribute the reduction of photosynthesis during SO<sub>2</sub> exposure. No increase or decrease in the rate of dark respiration was observed during the exposure to 1.5 ppm SO<sub>2</sub> for 1 hr (Fig. 3). Concerning this phenomenon, Taniyama et al. (14) reported an increase in dark respiration of SO<sub>2</sub>-exposed rice plants. But other workers (3, 9, 10) could not detect stimulatory effects of SO<sub>2</sub> on dark respiration rates in higher plants. From the present results and the results reported elsewhere, it appears that changes in dark respiration rates induced by SO<sub>2</sub> exposure are too small to have an appreciable effect on rates of net photosynthesis.

It can be postulated that the effects of SO<sub>2</sub> on photorespiration may be brought about by the inhibition of metabolic pathway of photorespiration and/or shortage of substances for photorespiration as a result of the inhibition of photosynthetic intermediates. According to Zelitch (17), sulfite caused a marked inhibition of glycolate oxidation system in vitro as well as in vivo. Spedding and Thomas (11) suggested that SO<sub>2</sub> may actually inhibit photorespiration possibly through the formation of  $\alpha$ -hydroxy-sulfonates (13) known as a specific inhibitor of glycolate oxidase. Zelitch (18) reported that the inhibition of photorespiration by the application of  $\alpha$ -hydroxy-sulfonates to tobacco leaves caused large increase in CO<sub>2</sub> fixation. More than 50 % of the newly fixed CO<sub>2</sub> during photosynthesis by many C<sub>3</sub>-plants may be released into the ambient atmosphere in the light by the process of photorespiration (19). So, it may be adequate to consider that the elimination of photorespiration without adversely affecting photosynthesis could significantly increase net photosynthesis. However, the net photosynthesis rate was not stimulated by SO<sub>2</sub>; on the contrary SO<sub>2</sub> caused reductions in both photosynthesis and photorespiration rates (Fig. 1, 4, 5). This result suggests that SO<sub>2</sub> inhibits not only photorespiratory glycolate oxidation system in peroxisomes but also photosynthetic CO<sub>2</sub> fixation in chloroplasts. (Since SO<sub>2</sub> had no effect on dark respiration, mitochondrial activity was not probably inhibited by SO<sub>2</sub>.) Furthermore, the suggestion that the reduction of photorespiration during SO<sub>2</sub> exposure is due to the shortage of photosynthetically produced substrate should be ruled out because the reduction of photorespiration was very rapid (Fig. 5).

Ziegler (20) reported that the inhibition of photosynthesis in isolated spinach chloroplast was due to the competition between bicarbonate and sulfite for the active site on ribulose-1,5-diphosphate carboxylase, central enzyme for photosynthetic CO<sub>2</sub> fixation. Shimazaki and Sugahara (9) studied inhibition of photosynthetic electron flow by SO<sub>2</sub>. They showed that SO<sub>2</sub> inhibited the electron flow driven by photosystem II occurred in chloroplast when plants were fumigated with SO<sub>2</sub>. From these reported results and the results presented here, we speculate that the reduction of net photosynthesis caused by SO<sub>2</sub> is primarily due to the breakdown of chloroplast activity rather than through changes in mitochondrial or peroxisomal activity or stomatal closure. If this

speculation is acceptable, SO<sub>2</sub> should induce an increase in the CO<sub>2</sub> compensation point as suggested from the Bravdo's study (4). We observed such an increase in the CO<sub>2</sub> compensation point during SO<sub>2</sub> exposure (Fig. 6).

#### References

1. Asada, K. and Z. Kasai: Inhibition of the photosynthetic carbon dioxide fixation of green plants by  $\alpha$ -hydroxysulfonates, and its effects on the assimilation products. *Plant & Cell Physiol.* 3:125-136 (1962).
2. Bazzaz, F.A. and J.S. Boyer: A compensation method for measuring carbon dioxide exchange, transpiration, and diffusive resistance of plants under controlled environmental condition. *Ecology* 53:343-349 (1972).
3. Black, V.J. and M.H. Unsworth: A system for measuring effects of sulphur dioxide on gas exchange of plants. *J. Exp. Bot.* 30:81-88 (1979).
4. Bravdo, B.A.: Decrease in net photosynthesis caused by respiration. *Plant Physiol.* 43:479-483 (1968).
5. Majernik, O. and T.H. Mansfield: Effects of SO<sub>2</sub> pollution on stomatal movement in *Vicia faba*. *Phytopath. Z.* 71:123-128 (1971).
6. Malhotra, S.S. and D. Hocking: Biochemical and cytological effects of sulphur dioxide on plant metabolism. *New Phytol.* 76:227-237 (1976).
7. Mudd, J.B. and T.T. Kozlowski: *Responses of plants to air pollution*, Academic Press, pp.383 (1975).
8. Ohshima, Y., T. Ushijima and T. Tazaki: Effects of atmospheric SO<sub>2</sub> on the photosynthetic and transpiratory rate of *Helianthus annuus*. *L. Environ. Control. in Biol.* 11:103-108 (1973).
9. Shimazaki, K. and K. Sugahara: Specific inhibition of photosystem II activity in chloroplasts by fumigation of spinach leaves with SO<sub>2</sub>. *Plant & Cell Physiol.* 20:26-35 (1979).
10. Sij, J.W. and C.A. Swanson: Short-term kinetic studies on the inhibition of photosynthesis by sulfur dioxide. *J. Environ. Quality* 8:103-107 (1974).
11. Spedding, D.J. and W.J. Thomas: Effects of sulfur dioxide on the metabolism of glycolic acid by barley (*Hordeum vulgare*) leaves. *Aust. J. Biol. Sci.* 26:281-286 (1973).
12. Soldatini, G.F. and I. Ziegler: Induction of glycolate oxidase by SO<sub>2</sub> in *Nicotiana tabacum*. *Phytochemistry* 18:21-22 (1979).
13. Tanaka, H., T. Takanashi and M. Yatazawa: Experimental studies on SO<sub>2</sub> injuries in higher plants. 1. Formation of glyoxylate-bisulfite in plant leaves exposed to SO<sub>2</sub>. *Water Air Soil Pollu.* 1:205-211 (1972).
14. Taniyama, T., H. Arikado, T. Iwata and K. Sawanaka: Studies on the mechanism of injurious effects of toxic gases on crop plants. On photosynthesis and dark respiration of the rice plant fumigation with sulfur dioxide for long period. *Proc. Crop Sci. Soc. Japan* 41:120-125 (1972).
15. Thomas, M.D. and G.R. Hill: Relation of sulphur dioxide in the atmosphere to photosynthesis and respiration of alfalfa. *Plant Physiol.* 12:309-383 (1937).
16. Tregunna, E.B., G. Krotkov and C.D. Nelson: Effects of oxygen on the rate of photorespiration in detached tobacco leaves. *Physiol. Plant.* 19:723-733 (1966).
17. Zelitch, I:  $\alpha$ -Hydroxysulfonates as inhibitors of the enzymatic oxidation of glycolic and lactic acids *J. Biol. Chem.* 224:251-260 (1957).
18. Zelitch, I: Increased rate of net photosynthetic carbon dioxide uptake caused by the inhibition of glycolate oxidase. *Plant Physiol.* 41:1623-1631 (1966).
19. Zelitch, I: Plant productivity and the control of photorespiration. *Proc. Nat. Acad. Sci. USA* 70:579-584 (1973).
20. Ziegler, I: The effects of SO<sub>3</sub><sup>2-</sup> on the activity of ribulose-1,5-diphosphate carboxylase in isolated spinach chloroplasts. *Planta* 103:155-163 (1972).

## Effects of low concentrations of SO<sub>2</sub> on the growth of sunflower

Hideyuki Shimizu, Akio Furukawa and Tsumugu Totsuka

Division of Environmental Biology, The National Institute for Environmental Studies,  
Yatabe, Ibaraki 305

Sunflower (*Helianthus annuus* L. cv. Russian Mammoth) was exposed to 0.05 or 0.1 ppm SO<sub>2</sub> for 5 weeks to investigate the effect of SO<sub>2</sub> on plant growth. Exposure to SO<sub>2</sub> was carried out in the controlled environment room under high light intensity (135 W m<sup>-2</sup>). Sunflower plants were harvested once a week to determine the relative growth rate (RGR), the net assimilation rate (NAR), the leaf area ratio (LAR), the leaf weight ratio (LWR) and the specific leaf area (SLA). No significant effect of SO<sub>2</sub> on the dry weight of the stem, root and whole plant was detected. However, the leaf area and the leaf dry weight of 0.05 and 0.1 ppm SO<sub>2</sub>-exposed plants were greater than those of control plants after 2 weeks exposure. Exposure to 0.1 ppm SO<sub>2</sub> for 4–5 weeks reduced the NAR by 20–25%, whereas the RGR was not affected. Exposure to 0.05 or 0.1 ppm SO<sub>2</sub> increased the LAR and the LWR but not the SLA. Exposure to 0.05 or 0.1 ppm SO<sub>2</sub> caused an increase in the dry weight of the withered leaves, a decrease in the dry weight of the flower bud and an inhibition of the stem elongation.

**Key words:** Sulfur dioxide – Plant growth – Sunflower – Growth analysis

In recent years, several investigators have conducted experiments with the effects on plant growth of prolonged exposures to low concentrations of SO<sub>2</sub>. However, the effects of low concentrations of SO<sub>2</sub> are not well defined. Furthermore, there has been some controversy as to whether beneficial effects occur during SO<sub>2</sub> exposure.

Bell and Clough (4) reported that continuous exposure to 0.12 ppm SO<sub>2</sub> for 9 weeks and 0.067 ppm for 26 weeks reduced the shoot growth of S 23 ryegrass by 50% relative to the control. They exposed ryegrass over autumn and winter in perspex chambers situated in an open-sided greenhouse without supplementary heat and light. Therefore, their experimental conditions, especially the light condition may not have been adequate for plant growth. This supposition may be sustained by their result of very poor growth in ryegrass. In contrast to this, Lockyer et al. (16) reported that exposure to 0.073 ppm SO<sub>2</sub> for 11 weeks did not reduce the growth of S 23 ryegrass, the same cultivar as used by Bell and Clough (4), whilst 0.146 ppm SO<sub>2</sub> did. Their experiment was carried out in a greenhouse from October with daily 16-hr supplementary illumination, maintaining a minimum light intensity of 30 W m<sup>-2</sup> at plant height. Thus, the light intensity may be somewhat higher than that applied by Bell and Clough (4), but it may be still insufficient for plant growth. Cowling and Koziol (8) exposed S 23 ryegrass to 0.016 or 0.147 ppm SO<sub>2</sub> for 51 days from late March in the greenhouse used by Lockyer et al. (16). However, they could not find a reduction of shoot growth of ryegrass for exposure to 0.147 ppm SO<sub>2</sub>. The difference between the results of Cowling and Koziol (8) and that of Lockyer et al. (16) may have resulted from the difference of the light conditions employed.



Cowling and Koziol exposed plants to  $\text{SO}_2$  under higher light intensity than that applied by Lockyer et al. From these conflicting results we assume that the light condition is an important factor in determining the sensitivity of plants to  $\text{SO}_2$ . All these investigations, even in the experiment of Cowling and Koziol, have been performed under relatively low light intensities, because the light intensity in greenhouse is usually extremely low compared with that in the field.

Ashenden and Mansfield (3) reported the importance of the rate of air movement across the leaves in relation to the effects of  $\text{SO}_2$ . Some workers (5, 6, 7, 16, 19) pointed out that the nutrients such as sulfur and nitrogen are important factors for determining the sensitivity of plants to  $\text{SO}_2$ . However, they exposed plants to  $\text{SO}_2$  under low light intensities. Therefore, there is a considerable doubt about the validity of their experimental results as to whether growth reduction occurs when plants are grown under high light intensity in the field. Furthermore, as all these investigators did not harvest plants periodically to make growth analysis, it is questionable whether exposure to  $\text{SO}_2$  could affect the plant growth continuously. In the present report, we will describe the effects of a 5-week exposure to 0.05 or 0.1 ppm  $\text{SO}_2$  on the dry matter production of sunflower under a high light intensity of  $135 \text{ W m}^{-2}$  with daily 14 hrs photoperiod.

#### Material and methods

##### *Plant material*

Seeds of sunflower (*Helianthus annuus* L. cv. Russian Mammoth) were obtained from plants grown in the Kawakami Farm situated near our Institute and were stocked at  $4^\circ\text{C}$  for a half year before use. Seeds were sterilized by dipping into 1 g/liter Benlate solution for 30 minutes and then rinsed with running tap water for 12 hrs. Three seeds were sown in each pot (11 cm in diameter and 20 cm high) containing vermiculite, peatmoss, perlite and fine gravel (2:2:1:1 v/v), in the controlled environment room. Six days after sowing, plants were thinned to one plant per pot. Nutrients were supplied twice a week using 1 g/liter Hyponex solution and for microelements Hoagland's No. 2 solution was used. Before sowing, 5 g Magamp K and 15 g magnesia lime were added to each pot.

##### *Exposure to $\text{SO}_2$*

The exposure to  $\text{SO}_2$  was performed 7 days after sowing for 5 weeks in the controlled environment room ( $170 \times 230 \times 190 \text{ cm}^3$ ). In the present experiment, we used 3 rooms. In two rooms,  $\text{SO}_2$  was injected into the air stream to maintain a constant concentration of 0.05 or 0.1 ppm  $\text{SO}_2$ . Another room was used as a control.

The field air was passed through activated charcoal and catalyst-bearing (containing MnOx and CuO) filters to remove ambient pollutants and led into the room. The filtration system removed  $\text{SO}_2$  very efficiently.  $\text{SO}_2$  from a compressed cylinder containing 1,000 or 2,000 ppm  $\text{SO}_2$  in  $\text{N}_2$  was injected through a thermal mass-flow controller into the gas stream. The concentration of  $\text{SO}_2$  in the room was continuously monitored and regulated using a controlling system based on a pulsed fluorescent  $\text{SO}_2$  analyzer (Thermo Electron Corporation, Model 43). Recording of the  $\text{SO}_2$  concentration inside the room showed that the concentration was regulated at  $0.05 \pm 0.005$  ppm or  $0.1 \pm 0.01$  ppm  $\text{SO}_2$ . Experimental conditions in the rooms were as follows: Air temperature was  $25 \pm 0.5^\circ\text{C}$  during the light period (14 hrs) and  $20 \pm 0.5^\circ\text{C}$  during the dark (10 hrs) with relative humidity of  $75 \pm 5\%$ . Light intensity was  $33 \text{ Klx}$  ( $135 \text{ W m}^{-2}$ ,  $600 \mu\text{E m}^{-2} \text{ sec}^{-1}$ )  $\pm 5 \text{ Klx}$  at plant height, and photosynthetically active radiation (PAR) was 96.6% of the total radiation. The light source was constructed from twenty-four 400 W stannous halide lamps (Yoko Lamp, Toshiba), and the emitted radiation was filtered

through a heat absorbing glass filter which removed radiation above 800 nm. The air velocity was 0.2–0.4 m sec<sup>-1</sup>, and ventilation rate was 1400 m<sup>3</sup> hr<sup>-1</sup> (ca. 190 times per hour). Measurement of environmental conditions ensured that the experimental conditions were uniform among the three rooms.

#### *Harvests and growth analysis*

Plants were harvested after sowing once a week from the 1st week to the 6th week. Plants were divided into leaf laminae, stem, flower, root and withered leaves. Leaf petiole was included in the stem part. Leaf area was measured by a planimeter (Hayashi Denko Co. Ltd., MODEL AMM-7), and the root was separated from the soil by sieving and washing. These plant parts were dried at 80–90°C for 2–3 days and then weighed.

The relative growth rate (RGR), the net assimilation rate (NAR), the leaf area ratio (LAR), the leaf weight ratio (LWR) and the specific leaf area (SLA) were calculated according to the following formulae (9):

$$\text{RGR} = (1/W) \cdot (dW/dt) = (\ln W_2 - \ln W_1) / (t_2 - t_1)$$

$$\text{NAR} = (1/\bar{F}) \cdot (dW/dt) = [(W_2 - W_1)(\ln \bar{F}_2 - \ln \bar{F}_1)] / [(t_2 - t_1)(\bar{F}_2 - \bar{F}_1)]$$

$$\text{LAR} = \bar{F}/W$$

$$\text{LWR} = F/W$$

$$\text{and SLA} = \bar{F}/F,$$

where  $W_i$  and  $\bar{F}_i$  are the dry weight of the whole plant and the leaf area at time  $t_i$ , respectively (i: 1 and 2), and F is the dry weight of the leaves.

## Results

### *Effects of SO<sub>2</sub> on dry matter production*

The effect of SO<sub>2</sub> on the dry weight growth of the whole plant is shown in Fig. 1. Plants were exposed to 0.05 or 0.1 ppm SO<sub>2</sub> for 5 weeks but visible symptoms of injury were not detected. Exposure to 0.1 ppm SO<sub>2</sub> induced an increase in the dry weight of whole plants by 15 (P<0.01) and 20% (P<0.05) at the 3- and 4-week harvests, respectively. However, there was no significant effect of 0.1 ppm SO<sub>2</sub> on the dry weight growth of the whole plant at other harvesting times. Exposure to 0.05 ppm SO<sub>2</sub> had no effect on the dry weight growth of the whole plant throughout the exposure period.

The effect of SO<sub>2</sub> on the distribution of photosynthate in the stem, root and leaf laminae is shown in Fig. 2, 3 and 4. The root dry weight of plants exposed to 0.1 ppm SO<sub>2</sub> was significantly greater than that of the control plants at the 3- and 5-week harvests (P<0.05). However, no significant difference was detected between the stem dry weight of plants exposed to 0.1 ppm SO<sub>2</sub> and that of the control plants. A significant increase in the leaf area of the 0.1 ppm SO<sub>2</sub>-exposed plants was observed at the 3-, 4- (P<0.001) and 5-week (P<0.05) harvests (Fig. 5). Exposure to 0.05 ppm SO<sub>2</sub> increased the leaf area at the 4- and 6-week harvests (P<0.01). The leaf dry weight of plants exposed to 0.1 ppm SO<sub>2</sub> was significantly greater than that of control plants at the 3- (P<0.01), 4- (P<0.001) and 5-week (P<0.01) harvests, whilst the leaf dry weight of 0.05 ppm SO<sub>2</sub>-exposed plants was greater than that of the control plants at the 6-week harvest (P<0.05).

### *Effects of SO<sub>2</sub> on growth attributes*

The exposure to 0.05 ppm SO<sub>2</sub> did not have any appreciable effect on the relative growth rate (RGR) throughout the exposure period (not shown in a figure). However, the RGR of 0.1 ppm SO<sub>2</sub>-exposed plants was smaller than that of the control plants

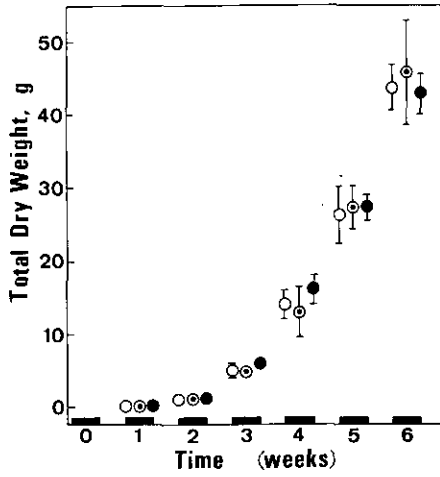

Fig. 1. The effect of  $SO_2$  on the dry weight growth of sunflower whole plant.  $SO_2$  exposures were started 1 week after sowing, and continued for 5 weeks. Each value is the mean of 10 plants. ○:0 ppm (control), ◉:0.05 ppm, ●:0.1 ppm  $SO_2$ . Vertical bars indicate  $2 \times$  standard deviation of mean.

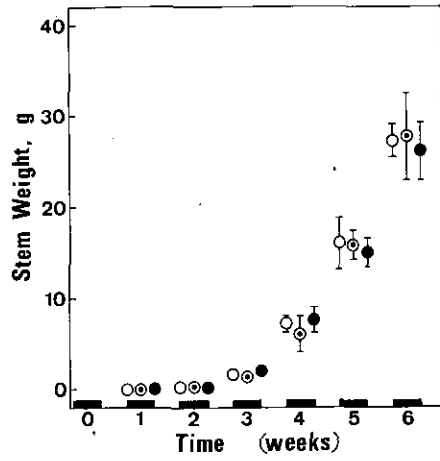

Fig. 2. The effect of  $SO_2$  on the stem dry weight growth of sunflower. See legend for Fig. 1.

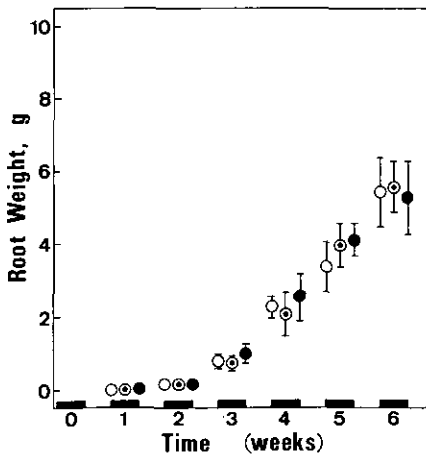

Fig. 3. The effect of  $SO_2$  on the root dry weight growth of sunflower. See legend for Fig. 1.

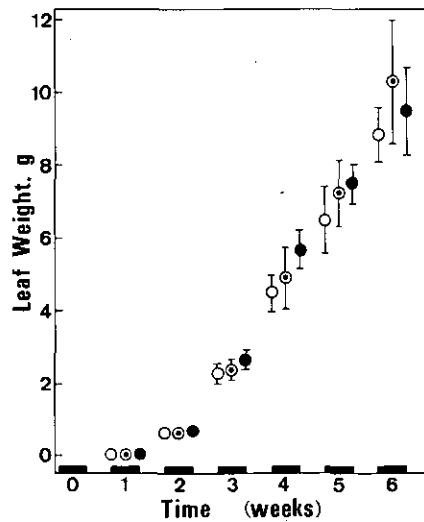

Fig. 4. The effect of  $SO_2$  on the leaf dry weight growth of sunflower. See legend for Fig. 1.

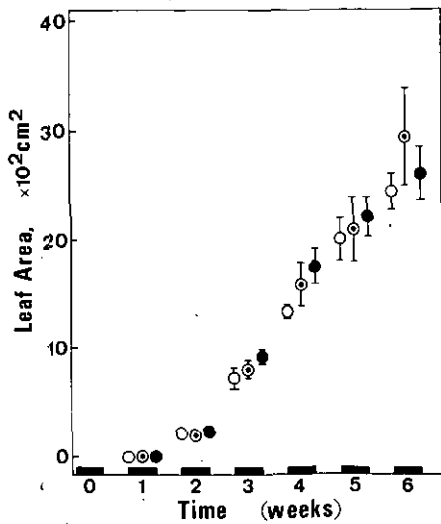

Fig. 5. The effect of SO<sub>2</sub> on the leaf area growth of sunflower. See legend for Fig. 1.

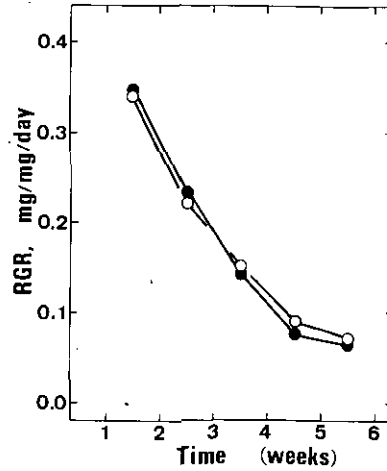

Fig. 6. The effect of SO<sub>2</sub> on the relative growth rate (RGR) of sunflower. SO<sub>2</sub> exposures were started 1 week after sowing and continued for 5 weeks. ○ : 0 ppm (control), ● : 0.1 ppm SO<sub>2</sub>.

during the later period of exposure (Fig. 6). The most remarkable effect of 0.1 ppm SO<sub>2</sub> on the RGR was detected between the 4- and 5-week harvests. Exposure to 0.1 ppm SO<sub>2</sub> reduced the RGR to 85% of the control value.

Exposure to 0.1 ppm SO<sub>2</sub> for 4-5 weeks reduced the NAR by 25% relative to the control (Fig. 7). The exposure to 0.05 ppm SO<sub>2</sub> also reduced the NAR (not shown in the figure), but the reduction was only 6%. The increase in leaf area without change in the dry weight of the whole plant and the decrease in the NAR without appreciable decrease in the RGR suggest an increase in the leaf area ratio (LAR) of the SO<sub>2</sub>-exposed plants (Fig. 8).

The LAR of plants exposed to 0.05 or 0.1 ppm SO<sub>2</sub> was greater than that of control plants throughout the exposure period. However, a higher value of the LAR was observed for plants exposed to 0.05 ppm SO<sub>2</sub> compared with those exposed to 0.1 ppm SO<sub>2</sub>. The LAR of 0.05 ppm SO<sub>2</sub>-exposed plants was significantly greater than that of control plants at the 3-, 4- and 6-week harvests ( $P < 0.01$ ), whereas 0.1 ppm SO<sub>2</sub> induced a significant increase in the LAR only at the 4-week harvest ( $P < 0.05$ ). For further analysis, the LAR was divided into the LWR and the SLA.

If leaf thickness is reduced by SO<sub>2</sub> exposure, the SLA should increase. If SO<sub>2</sub> induced the accumulation of photosynthate in the leaves, the LWR should increase. The results shown in Fig. 9 and 10 indicate that changes in the LAR during exposure to 0.05 or 0.1 ppm SO<sub>2</sub> were attributable to changes in the LWR, i.e. the SLA did not change for plants exposed to the various concentrations of SO<sub>2</sub>.

We also demonstrated the effects of SO<sub>2</sub> on some other factors. The effects were observed at the final harvest (Table 1). Flower bud formation was inhibited significantly ( $P < 0.01$ ) by 0.05 and 0.1 ppm SO<sub>2</sub>. Flower dry weight was reduced to 48 and 43% of that

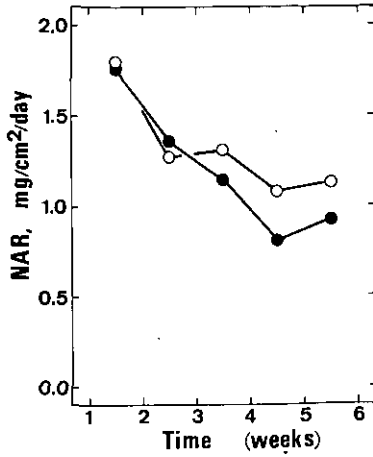

Fig. 7. The effect of  $SO_2$  on the net assimilation rate (NAR) of sunflower. See legend for Fig. 6.

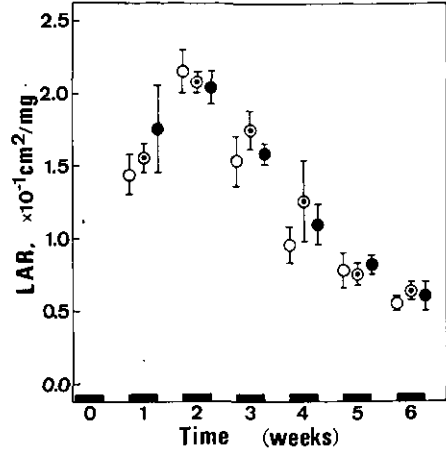

Fig. 8. The effect of  $SO_2$  on the leaf area ratio (LAR) of sunflower. See legend for Fig. 1.

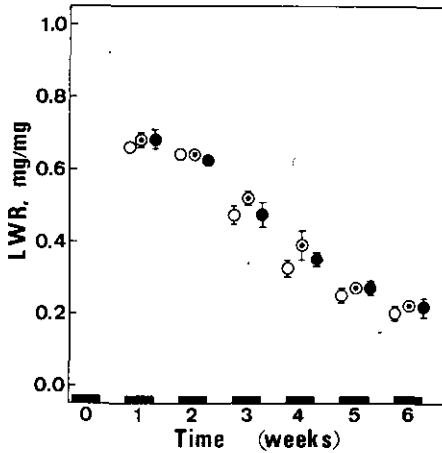

Fig. 9. The effect of  $SO_2$  on the leaf weight ratio (LWR) of sunflower. See legend for Fig. 1.

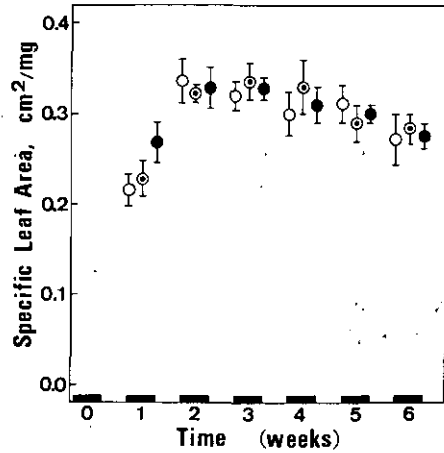

Fig. 10. The effect of  $SO_2$  on the specific leaf area (SLA) of sunflower. See legend for Fig. 1.

of control plants by exposure to 0.05 and 0.1 ppm  $SO_2$ , respectively. This result may indicate that  $SO_2$  could affect the partitioning of photosynthates required for growth of the flower organ.

A reduction of stem elongation for  $SO_2$ -exposed plants was observed. The stem elongation (designated as 'plant height' in Table 1) was reduced to 91% and 87% by exposure to 0.05 and 0.1 ppm  $SO_2$  for 5 weeks, respectively. Peiser and Yang (18) indicated that

SO<sub>2</sub> effects on plant growth

Table 1 *The effects of SO<sub>2</sub> on growth attributes of sunflower at the 6-week harvest\**

	SO <sub>2</sub> concentration (ppm)		
	0.00	0.05	0.10
Total dry weight (g)	43.63 ± 3.10	45.74 ± 7.51	42.79 ± 2.59
Leaf area (dm <sup>2</sup> )	24.30 ± 1.68	29.24 ± 4.62 <sup>b</sup>	25.99 ± 2.51
Withered leaves weight (g)	0.83 ± 0.32	1.08 ± 0.52	1.27 ± 0.55 <sup>a</sup>
Flower dry weight (g)	0.89 ± 0.36	0.38 ± 0.28 <sup>b</sup>	0.43 ± 0.34 <sup>b</sup>
Plant height (cm)	142.4 ± 4.5	129.5 ± 11.6 <sup>b</sup>	124.5 ± 10.8 <sup>c</sup>

\* Each value is the mean of 10 plants ± standard deviation.

<sup>a,b</sup> and <sup>c</sup> indicate mean values that are significantly different from control at the 0.05, 0.01 and 0.001 levels, respectively.

plants exposed to 0.7 ppm SO<sub>2</sub> for 8 hours produced ethylene and ethane at levels almost 10 and 5 times greater than the control plants, respectively. We assume that even for exposure to low concentrations of SO<sub>2</sub>, ethylene production may be promoted in sunflower, resulting in a reduction of stem elongation.

The most significant effect of SO<sub>2</sub> was the promotion of the leaf senescence. The dry weight of withered leaves increased with increasing concentration of SO<sub>2</sub>, but we could not detect a significant effect of 0.05 ppm SO<sub>2</sub> on leaf senescence. The promotive effect of SO<sub>2</sub> on leaf senescence was also demonstrated by Bell and Clough (4) in the greenhouse and by Heitschmidt et al. (13) in the field.

### Discussion

It is noteworthy that low concentrations of SO<sub>2</sub> reduced the NAR (Fig. 7), while the RGR was hardly affected (Fig. 6). The NAR began to decrease 2 weeks after the exposure. This result coincided with the estimation of Furukawa and Totsuka (10) who reported that a 10% reduction in the rate of net photosynthesis in sunflower leaves was attributable to exposure to 0.04 ppm SO<sub>2</sub> for 7–14 days. From the growth analysis, we suspect that the reduction of the NAR of SO<sub>2</sub>-exposed plants was compensated for an increase in the LAR (Fig. 8), and thus the RGR did not change. However, the RGR of plants exposed to 0.1 ppm SO<sub>2</sub> declined at the later period of the exposure (Fig. 6). This observation suggests that prolonged exposure to SO<sub>2</sub> may reduce the production of plant matter.

Exposure to 0.05 ppm SO<sub>2</sub> for 3 weeks induced an increase of 18% in the LWR relative to non-exposed plants. Summing up the results of other investigators, Evans (9) reported that changes in temperature between 15 and 20°C and changes in light intensity between 1.2 and 2.6 cal dm<sup>-2</sup>min<sup>-1</sup> had no effect on the LWR. Since the LWR is the ratio of the dry weight of leaves to that of the whole plant, an increase in the LWR would reflect a decrease in the distribution ratio of photosynthates to other organs, i.e. stem, flower and root. This speculation is supported by the present results of inhibition of flower formation and/or increase in leaf area and leaf dry weight growth.

In the present study, we could not detect significant effects on the dry weight growth of sunflower whole plants exposed to 0.05 or 0.1 ppm SO<sub>2</sub> for 5 weeks. Some

investigations have been conducted concerning the effects of low concentrations of SO<sub>2</sub> on plant growth using the greenhouse (2, 4, 6, 7, 8, 12, 16, 20, 21, 22) or controlled environment room (1, 3, 5, 14, 15, 17, 19). Plants should react to SO<sub>2</sub> in a different manner depending not only on the concentration and duration of exposure to the gas but also on a number of other factors, e.g. species and nutritional and environmental conditions. Nutritional conditions (5, 6, 7, 16, 19) or wind speed (3) have been reported to be an important factor controlling the effects of SO<sub>2</sub> on plant growth. However, little attention has been paid to other environmental conditions, especially light intensity which is known to be an important factor for plant metabolism and growth. The light intensity transmitted through the glass of greenhouse is usually reduced to 50–70% compared with the light intensity in the field. In our Institute, the phytotron greenhouses have single and double paired glass which reduce the light intensity to 63 and 46% of that in the field, respectively. Plants grown under these low light intensities have the characteristics of the so-called "shade plants". We assume from our preliminary experiment that shade plants are characterized by thin leaves which have high sensitivity to air pollutants.

The annual mean concentrations of SO<sub>2</sub> in urban and industrial areas in Japan often exceed 0.02 ppm SO<sub>2</sub>. If the growth of plants grown in these areas is reduced to 50% compared to plants from unpolluted areas, naturally grown vegetation may be heavily damaged, and a floral change will occur in the field. Furukawa et al. (11) investigated the growth of golden rod from May to October in the field near a power plant where the atmospheric concentration of SO<sub>2</sub>, hourly mean max. in the daytime, can be as high as 0.04 ppm (the mean SO<sub>2</sub> concentration from June to October was 0.01 ppm). However, they could not find the reduction of dry matter production for golden rod relative to the same species grown in the area where no detectable concentration of SO<sub>2</sub> was present. From these results and speculations, we conclude that the dry matter production of plants which is generally resistant to SO<sub>2</sub> is hardly affected by low concentrations of SO<sub>2</sub> under full sunlight conditions in the field, whereas physiological changes may occur for the same plants under the same conditions.

#### References

1. Ashenden, T. W.: Growth reductions in cocksfoot (*Dactylis glomerata* L.) as a result of SO<sub>2</sub> pollution. *Environ. Pollut.* 15:161–166 (1978).
2. Ashenden, T. W.: The effects of long-term exposures to SO<sub>2</sub> and NO<sub>2</sub> pollution on the growth of *Dactylis glomerata* L. and *Poa pratensis* L.. *Environ. Pollut.* 18:249–258 (1979).
3. Ashenden, T. W. and T. A. Mansfield: Influence of wind speed on the sensitivity of ryegrass to SO<sub>2</sub>. *J. Exp. Bot.* 28(104):729–735 (1977).
4. Bell, J. N. B. and W. S. Clough: Depression of yield in ryegrass exposed to sulphur dioxide. *Nature* 241:47–49 (1973).
5. Cowling, D. W., L. H. P. Jones and D. R. Lockyer: Increased yield through correction of sulphur deficiency in ryegrass exposed to sulphur dioxide. *Nature* 243:479–480 (1973).
6. Cowling, D. W. and D. R. Lockyer: Growth of perennial ryegrass (*Lolium perenne* L.) exposed to a low concentration of sulphur dioxide. *J. Exp. Bot.* 27(98):411–417 (1976).
7. Cowling, D. W. and D. R. Lockyer: The effect of SO<sub>2</sub> on *Lolium perenne* L. grown at different levels of sulphur and nitrogen nutrition. *J. Exp. Bot.* 29(108):257–265 (1978).
8. Cowling, D. W. and M. J. Koziol: Growth of ryegrass (*Lolium perenne* L.) exposed to SO<sub>2</sub>. *J. Exp. Bot.* 29(112):1029–1036 (1978).
9. Evans, G. C.: *The quantitative analysis of plant growth*. William Clowes and Sons limited, London. 1972.
10. Furukawa, A. and T. Totsuka: Effect of sulfur dioxide on net photosynthesis and stomatal

- aperture in sunflower leaves. *Report of Special Research Project, the National Institute for Environmental Studies* No.2: 57-66 (1978) (in Japanese).
11. Furukawa, A., Y. Matsuoka and T. Totsuka: Field studies on the dry matter growth of golden rod plant community and the physiological activity of plant community as a sink of air pollutant in air-polluted area. *Research Report from the National Institute for Environmental Studies* No. 10: 177-210 (1979) (in Japanese).
  12. Heagle, A. S., D. E. Body and G. E. Neely: Injury and yield responses of soybean to chronic doses of ozone and sulfur dioxide in the field. *Phytopathology* 64:132-136 (1974).
  13. Heitschmidt, R. K., W. K. Lauenroth and J. L. Dodd: Effects of controlled levels of sulphur dioxide on western wheatgrass in a south-eastern Montana grassland. *J. Appl. Ecol.* 14:859-868 (1978).
  14. Jäger, H.-J. and H. Klein: Biochemical and physiological detection of sulfur dioxide injury to pea plants (*Pisum sativum*). *J. Air Poll. Control Ass.* 27(5):464-466 (1977).
  15. Klein, H., H.-J. Jäger, W. Domes and C. H. Wong: Mechanisms contributing to differential sensitivities of plants to SO<sub>2</sub>. *Oecologia* (Berl.) 33:203-208 (1978).
  16. Lockyer, D. R., D. W. Cowling and L. H. P. Jones: A system for exposing plants to atmospheres containing low concentrations of sulphur dioxide. *J. Exp. Bot.* 27(98): 397-409 (1976).
  17. Mandl, R. H., L. H. Weinstein and M. Keveny: Effects of hydrogen fluoride and sulphur dioxide alone and in combination on several species of plants. *Environ. Pollut.* 9:133-143 (1975).
  18. Peiser, G. D. and S. F. Yang: Ethylene and ethane production from sulfur dioxide-injured plants. *Plant Physiol.* 63:142-145 (1979).
  19. Priebe, A., H. Klein and H.-J. Jäger: Role of polyamines in SO<sub>2</sub>-polluted pea plants. *J. Exp. Bot.* 29(112): 1045-1050 (1978).
  20. Tingey, D. T., W. W. Heck and R. A. Reinert: Effect of low concentrations of ozone and sulfur dioxide on foliage, growth and yield of radish. *J. Amer. Soc. Hort. Sci.* 96(3): 369-371 (1971).
  21. Tingey, D. T., R. A. Reinert, C. Wicklife and W. W. Heck: Chronic ozone or sulfur dioxide exposures, or both, affect the early vegetative growth of soybean. *Can. J. Plant Sci.* 53:875-879 (1973).
  22. Tingey, D. T. and R. A. Reinert: The effect of ozone and sulphur dioxide singly and in combination on plant growth. *Environ. Pollut.* 9:117-125 (1975).



## A model for estimating SO<sub>2</sub> effects on canopy photosynthesis in sunflower plants

Tsumugu Totsuka

Division of Environmental Biology, The National Institute for Environmental Studies,  
Yatabe, Ibaraki 305

Interrelationships among SO<sub>2</sub> concentration, light intensity, leaf area index and canopy photosynthesis were discussed using a mathematical model. The model was based on equation (1), which represented the time trend in photosynthesis rate of a single leaf exposed to SO<sub>2</sub>. As to variables in equation (1), the exponent of the equation, which was designated as an inhibition coefficient of photosynthesis, could be formulated as a function of the leaf area index (LAI), SO<sub>2</sub> concentration and the light intensity (eq. (8)). Equation (9) was introduced to estimate the effects of SO<sub>2</sub> on the canopy photosynthesis of sunflower populations. The results obtained from the numerical calculation of equation (9) were as follows: When the SO<sub>2</sub> concentration was below 0.2 ppm, inhibition of canopy photosynthesis of the sunflower foliage with a LAI of 4 was negligible for 60 min fumigation, regardless of light intensity. However, at 0.4 ppm SO<sub>2</sub> for 5 hrs and 10 hrs fumigation at 40 klx, the photosynthesis of the foliage decreased to 92 % and 84 % of the control value respectively; at 0.2 ppm SO<sub>2</sub> the photosynthesis scarcely decreased the respective values being 98 % and 97 %. The rate at which photosynthesis was inhibited increased with decrease of the LAI below 4.0, especially for SO<sub>2</sub> concentrations above 0.4 ppm.

**Key words:** Mathematical models – Sulfur dioxide exposure – Canopy photosynthesis  
– Sunflower plants

The effects of sulfur dioxide on the net photosynthesis of plants have been studied intensively by Thomas and his associates (1951). Studies by Thomas et al. (1961) showed that sulfur dioxide at low concentrations decreased net photosynthesis without visible injury but when gas exposure ended the photosynthesis was rapidly restored to normal. Recently, several works have been reported concerning the effects of SO<sub>2</sub> on net photosynthesis in several plant species. Taniyama (1972), Sij and Swanson (1974), and Matsuoka (1978) have investigated time trends of net photosynthesis rate during fumigation with SO<sub>2</sub> in corn and pinto bean (8), paddy rice and rape (9) and rice plant (3). Oshima et al. (1973) and Matsuoka (1978) have described relationship between the effects of SO<sub>2</sub> and light-photosynthesis for sunflower (5) and rice plants (3). In the investigations, detached leaf or whole plants were used. However, there have been no studies concerning the effects of SO<sub>2</sub> on canopy photosynthesis except for the report by Thomas and Hill (1937) who studied alfalfa foliage.

In this paper, a mathematical model for predicting the changes of canopy photosynthesis of sunflower plants under fumigation with SO<sub>2</sub> is developed, based on

data on the effects on leaf photosynthesis of sunflower plants which have been reported by Furukawa and Totsuka (1978). Using the mathematical model, interrelationships among SO<sub>2</sub> concentration, light intensity, leaf area index and canopy photosynthesis are discussed for sunflower populations.

### I. Effects of SO<sub>2</sub> on a leaf photosynthesis in sunflower plants

As reported by Furukawa and Totsuka (1), a leaf photosynthesis of sunflower plants is very sensitive to SO<sub>2</sub> exposure. Experiments were performed by the following procedures: Potted sunflower plants (*Helianthus annuus* L. cv. Russian Mammoth) were grown in a phytotron greenhouse in summer at temperatures of 25 ± 0.1°C (day) and 20 ± 0.1°C (night) and relative humidity of 75 ± 5%. When the plants were 5–6 weeks old, the photosynthesis of detached leaves was measured with an assimilation chamber installed in the gas exposure cabinet (1.7 × 2.3 × 2.0 m high). In the cabinet, the light source consisted of twenty-four 400 W metal-halide lamps. The emitted light was passed through a heat absorbing filter to remove radiation above 800 nm. Ambient air was introduced into the cabinet after having passed through an activated charcoal filter to remove air pollutants. The ventilation rate was about 30 times/hr. The velocity of air passing horizontally through the cabinet was 0.2–0.4 m/s. The SO<sub>2</sub> concentration of air in the cabinet was regulated by injecting a certain volume of SO<sub>2</sub> gas through a thermal mass-flow controller, and monitoring the SO<sub>2</sub> concentrations by a SO<sub>2</sub> analyzer (Thermo Electron, Model 43).

The detached leaf was placed in the assimilation chamber (17.5 × 30 cm<sup>2</sup> and 2 cm deep) with its petiole immersed in a small glass vial containing distilled water. Prior to fumigation with SO<sub>2</sub>, the leaf in the chamber was preilluminated for more than an hour at a light intensity of 36 klx to obtain a steady state of photosynthetic CO<sub>2</sub> uptake under clean air conditions. When the photosynthetic activity reached a steady state, the air surrounding the chamber with a given SO<sub>2</sub> concentration was introduced into the assimilation chamber at a flow rate of 10 l/min to expose the leaf to the air containing the SO<sub>2</sub> gas under experimental conditions of 25°C (air), 75% RH and 36 klx. The rate of photosynthesis was determined by measuring the difference in the CO<sub>2</sub> concentration for the air inlet and outlet of the chamber using an infrared CO<sub>2</sub> gas analyzer (Shimazu, Model URA-2S).

Fig. 1 shows the time trend of the net photosynthesis of leaves with different leaf ages during fumigation with SO<sub>2</sub> at 1.0 ppm, which has been reported by Furukawa and Totsuka (1). The values in the ordinates of the figure are expressed as a percent of the rate of the net photosynthesis prior to gas exposure. Changes of net photosynthesis rate with time in Fig. 1-A were simply expressed by the two straight lines on a semi-logarithmic plot (Fig. 1-B). The slopes of the straight lines changed after a fumigation time of about 30 min. However, at relatively low SO<sub>2</sub> concentrations, the rate of net photosynthesis, plotted on logarithmic scale, decreased almost linearly during the fumigation time for more than 90 min. The linear relationship between net photosynthesis and time in Fig. 1-B can be formulated by

$$P_t/P_0 = a \exp(-bt), \quad (1)$$

where P<sub>0</sub> and P<sub>t</sub> refer to the net photosynthesis rates prior to gas exposure and those after the gas exposure for a certain time *t*, respectively. The slope of the straight line is

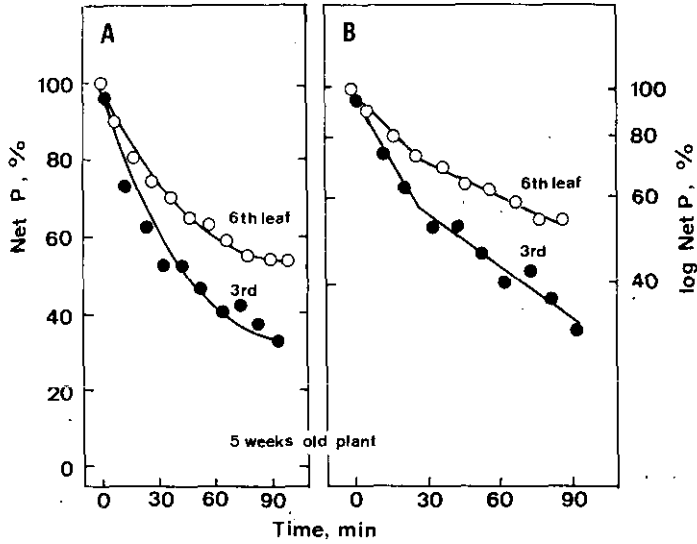

Fig. 1. Time changes of net photosynthesis rate of sunflower leaves for different leaf ages under fumigation with SO<sub>2</sub> at 1.0 ppm. Numerals in the figures show the leaf order numbered from the cotyledon. Measurements at 25°C and 36 klx. Net photosynthetic rates (Net P) plotted as the ordinate are the percent of the initial value. Fig. 1-B shows the same data as in Fig. 1-A, but data were plotted on logarithmic scale.

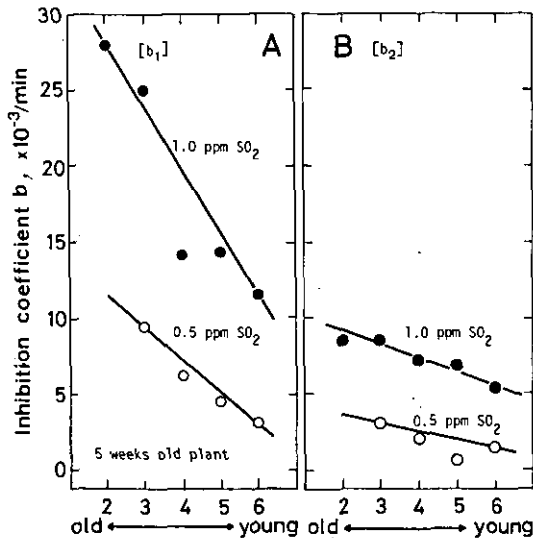

Fig. 2. Changes of the inhibition coefficient of b<sub>1</sub> (left) and b<sub>2</sub> in different leaf ages of sunflower plants. Numerals in the abscissa show the leaf order numbered from the cotyledon. Measuring conditions are the same as in Fig. 1.

determined by  $b$ , which can be considered as an indicator which expresses the extent of inhibitory effects of  $\text{SO}_2$  on the net photosynthesis rate. The value of  $b$  has been designated as the 'inhibition coefficient of photosynthesis' in relation to the effect of  $\text{SO}_2$  (1). The initial and the second slopes of the lines in Fig. 1-B are designated as the 1st ( $b_1$ ) and the 2nd ( $b_2$ ) inhibition coefficients, respectively.

Fig. 2 summarizes the effects of 1.0 or 0.5 ppm  $\text{SO}_2$  on the net photosynthesis of leaves of different ages. The increase of the inhibition coefficient in older leaves was apparent at both  $\text{SO}_2$  concentrations. The inhibition coefficient,  $b_1$ , increased progressively with increasing leaf age. This increase of  $b_1$  appeared to be more pronounced at 1.0 ppm  $\text{SO}_2$  exposure than at 0.5 ppm  $\text{SO}_2$ . For example, the values of  $b_1$  for the 6th (younger) leaf was 30 % of that for the 3rd (older) leaf at 0.5 ppm  $\text{SO}_2$ , while for 1.0 ppm  $\text{SO}_2$  the corresponding figure was 45 %. The value of  $b_1$  was always higher than that of  $b_2$  at any leaf age for exposure to relatively high  $\text{SO}_2$  concentrations such as 0.5 and 1.0 ppm.

As shown in Fig. 3, the inhibition coefficient,  $b_1$ , increased remarkably with increasing  $\text{SO}_2$  concentration above 0.5 ppm, while  $b_2$  did not increase so much as compared with  $b_1$ . When the  $\text{SO}_2$  concentration was 1.0 ppm,  $b_1$  in the older (2nd) leaf was about 3 times that in the younger (5th) leaf. Below 0.5 ppm  $\text{SO}_2$ , both  $b_1$  and  $b_2$  became distinctly smaller for any leaf age tested.

Fig. 4 shows the relation between the inhibition coefficient  $b_1$  and the light intensity under fumigation with  $\text{SO}_2$  at 1.0 ppm. The plotted values include those obtained in leaves of different leaf ages from the 2nd to the 6th leaves in Fig. 2. As shown by the solid line, which is a fit of the maximum values of  $b_1$  for each light intensity, the coefficient,  $b_1$ , increased remarkably with increase of light intensity and tended to become saturated under illuminations above 40 klx.

In Fig. 5, inhibition coefficients for  $b_2$  were plotted against those of  $b_1$ , showing a

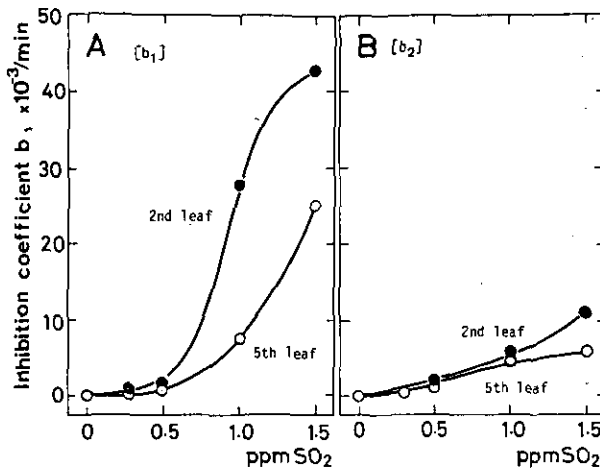

Fig. 3. Effects of  $\text{SO}_2$  concentration on the inhibition coefficient of  $b_1$  (left) and  $b_2$  at the 2nd (older) and 5th (younger) leaves of sunflower plants. Measuring conditions are the same as in Fig. 1.

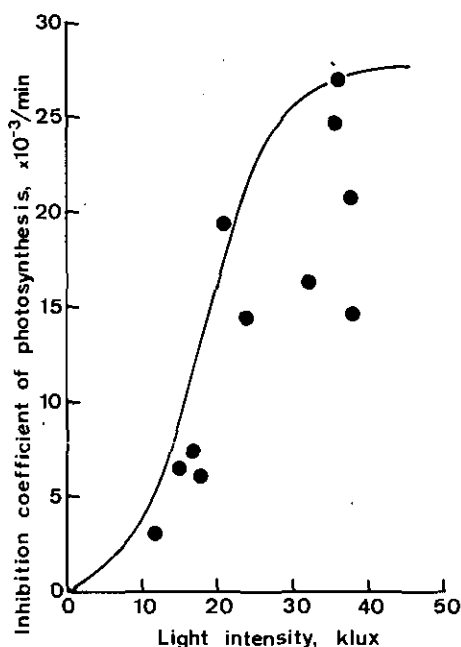

Fig. 4. Effect of light intensity on the inhibition coefficient  $b_1$  of sunflower leaves fumigated at 1.0 ppm SO<sub>2</sub>. The continuous line covers the maximum values obtained for  $b_1$  at different light intensities.

linear relationship between the two. The plotted data were obtained from measurements on leaves of different ages for SO<sub>2</sub> concentrations in the range, 0.3 to 1.5 ppm, and for different light intensities of 2.5–38 klx. When  $b_1$  was below  $2.5 \times 10^{-3}$ /min,  $b_2$  equaled  $b_1$ , as shown in the open circles in the figure. This indicates that the straight line in Fig. 1-B does not bend under fumigations with relatively low SO<sub>2</sub> concentrations such as 0.3 ppm or below (cf. Fig. 3). However, when  $b_1$  becomes greater than  $2.5 \times 10^{-3}$ /min under fumigation with relatively high SO<sub>2</sub> concentrations,  $b_2$  decreased to 20–40 % of  $b_1$ .

## II. Mathematical model for calculating canopy photosynthesis under fumigation with SO<sub>2</sub>

Time trends of the photosynthesis rate affected by SO<sub>2</sub> fumigation have been formulated by the exponential equation, as indicated in the previous chapter. In equation (1),  $P_0$  is the initial rate of net photosynthesis of a single leaf prior to fumigation, and is expressed as a function of light intensity received. The relation of  $P_0$  to light intensity is in general formulated by the following rectangular hyperbolic equation. That is,

$$P_0 = \frac{BI}{1 + AI} - R \quad (2)$$

where  $I$  is the light intensity illuminating the leaf surface,  $R$  is the respiration rate of a single leaf, and  $A$  and  $B$  are constants. The light-photosynthesis curve of sunflower leaves under clean air conditions is indicated in Fig. 6, which was obtained by the method mentioned in the previous chapter.

As for the light intensity ( $I$ ) received on the leaf surface within a plant canopy, Saeki

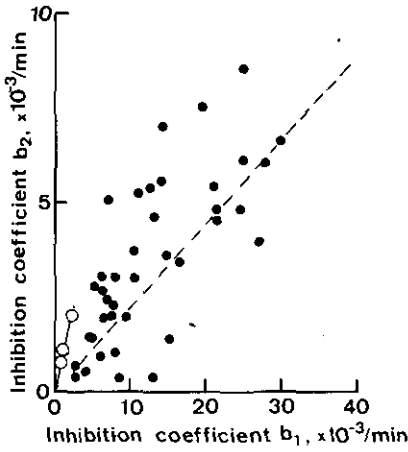

Fig. 5. Relationship between the inhibition coefficient of  $b_1$  and that of  $b_2$ . Open circles show that the values of  $b_1$  are equivalent to  $b_2$ . Measurements were done in sunflower leaves with different leaf ages under fumigation with  $\text{SO}_2$  at 0.3–1.5 ppm.

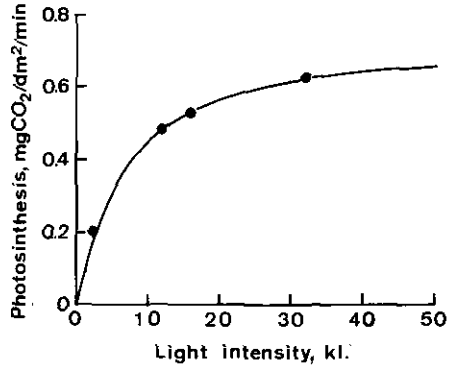

Fig. 6. Light-photosynthesis curve of a single leaf in sunflower plants. Measurements at 25°C, 70% RH. Leaf respiration rate was 0.067 mg  $\text{CO}_2/\text{dm}^2/\text{min}$ .

(6) has proposed the following equation. That is,

$$I = I_0 \exp(-KF)/(1 - m) \quad (3)$$

where  $I_0$  represents the incident light intensity above the plant canopy,  $K$  is the extinction coefficient of light in the canopy (4),  $m$  is the light transmissivity of a leaf (2) and  $F$ , the leaf area index (LAI,  $\text{m}^2/\text{m}^2$  land area). Then, the photosynthesis rate of a leaf within the plant canopy can be estimated by equation (2) where the light intensity  $I$  is substituted by equation (3). Insertion of equation (2) (including equation (3)) into equation (1) and its integration with respect to the LAI gives changes with time of the canopy photosynthesis rate ( $P_s^c$ ) as a function of the incident light intensity ( $I_0$ ) and LAI ( $F$ ) during  $\text{SO}_2$  fumigation.

On the other hand, canopy photosynthesis of foliage without  $\text{SO}_2$  fumigation ( $P_0^c$ ) can be estimated by equation (4), which has been presented by Saeki (6) as a function of LAI ( $F$ ) and incident light intensity above the canopy ( $I_0$ ).

$$P_0^c = \frac{B}{KA} \ln \frac{(1 - m) + KAI_0}{(1 - m) + KAI_0 \exp(-KF)} - RF \quad (4)$$

In equation (4),  $K$  and  $m$  are the same constants as in equation (3) and  $R$ ,  $A$  and  $B$  are the same as in equation (2). As mentioned in the previous chapter, the inhibition coefficient ( $b$ ) in equation (1) can vary with light intensity,  $\text{SO}_2$  concentration and leaf age. In the foliage canopy of sunflower plants, older leaves will dominate the lower layers of the foliage. The relationship between leaf age and leaf area index of the foliage was investigated in sunflower populations (planting density of 18 plants/ $\text{m}^2$ , as reported by Shimizu and Totsuka (7) where the plants were grown for 5 weeks in a phytotron greenhouse as mentioned in the previous chapter). Those populations had a LAI of about

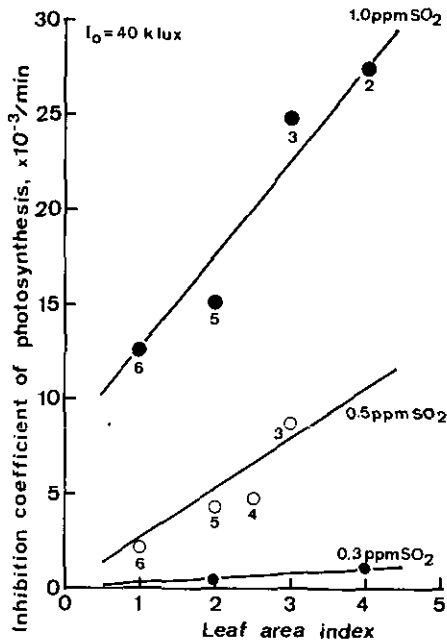

Fig. 7. Inhibition coefficient,  $b_1$ , plotted against leaf area index numbered from the top layer of the foliage canopy. Numerals in the figure show leaf order corresponding to those in Fig. 2.

4. As a result, it was indicated that the 6th, 5th, 3rd and 2nd leaves shown in Fig. 2 corresponded mostly to the 1st (= the uppermost layer), 2nd, 3rd and 4th (= the lowest layer) layers of the LAI. Using this relationship between leaf age and LAI, the data in Fig. 2 were rearranged to indicate the relation of the inhibition coefficient  $b_1$  to the leaf area index, as shown in Fig. 7. Values at 0.3 ppm SO<sub>2</sub> shown in Fig. 7 were redrawn from Fig. 3. Therefore, the inhibition coefficient,  $b_1$ , plotted against the leaf area index could be formulated, as

$$b_1 = (5F + 7.8) \times 10^{-3} \quad (5)$$

where the SO<sub>2</sub> concentration was 1.0 ppm and the light intensity was 40 klx. Fig. 8 shows the relationship between the inhibition coefficient  $b_1$  and the SO<sub>2</sub> concentration at the 1st ( $F=1$ ) and the 4th ( $F=4$ ) LAIs in sunflower populations, which was based on the data in Fig. 7. Changes of the coefficient  $b_1$  could be expressed as a function of SO<sub>2</sub> concentration. The  $b_1$  value at the 4th LAI in Fig. 7 was formulated by

$$b_1 = 27.8 S^{2.7} \times 10^{-3} \quad (6)$$

The value of  $b_1$  at 1.0 ppm SO<sub>2</sub> can be varied with the position of the LAI, as expressed by equation (5). Therefore, the relation of  $b_1$  to the LAI and the SO<sub>2</sub> concentration ( $S$ ) can be expressed by equation (7).

$$b_1 = (5F + 7.8) \times 10^{-3} \times S^{2.7} \quad (7)$$

Here, the LAI and the SO<sub>2</sub> concentration applicable to equation (7) are limited to the range of 0 ~ 4 for the LAI and 0 ~ 1.0 ppm for the SO<sub>2</sub> concentration.

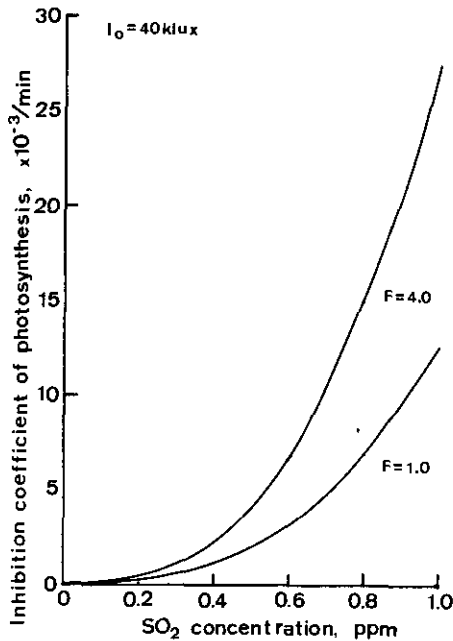

Fig. 8. Change of the coefficient  $b_1$  with increase of  $SO_2$  concentrations. The same data as those at the 1st and the 4th LAI in Fig. 7.

On the other hand, the relationship between the coefficient  $b_1$  and the light intensity, as already shown in Fig. 4, was presented by a logistic equation to approximate maximum values (mostly measured at older leaves) at each light intensity. The equation obtained was

$$b_1 = \frac{K_m}{1 + 58.36 \exp(-0.219 I)} \quad (8)$$

where  $K_m$  corresponds to the value of  $b_1$  obtained under the saturated light intensity. The value  $K_m$  depends on  $SO_2$  concentrations in leaves with different leaf ages which are included in the corresponding LAIs shown in Fig. 7 (cf. Fig. 8). Equation (7) represents the changes of  $K_m$ . In Fig. 4 which represents data obtained at 1.0 ppm  $SO_2$  under different light intensities, the value  $K_m$  shown in the continuous line was  $27.8 \times 10^{-3}$ .

Using equations (7) and (8), the inhibition coefficient  $b_1$  in leaves positioned at the upper (1st) and the lower (4th) layer of the LAI in the foliage canopy of sunflower populations was calculated for 0.5 and 1.0 ppm  $SO_2$  with different light intensities, as shown in Fig. 9. Fig. 10 also shows the calculated inhibition coefficient  $b_1$  in leaves within the plant canopy where mutual shading of leaves occurs and the light intensity received on the leaf surface can be expressed by equation (3). It is shown that at the lower layers of the LAI, the coefficient will be decreased strikingly even at higher  $SO_2$  concentrations, because the light intensity illuminated on the leaf surface is exponentially attenuated by the foliage canopy.

The relationship between the inhibition coefficient  $b_1$  (= the value in the first 30 min after starting gas exposure) and that of  $b_2$  (= the value for exposure times more than 30 min) has been indicated in Fig. 5 in the previous chapter. That is,



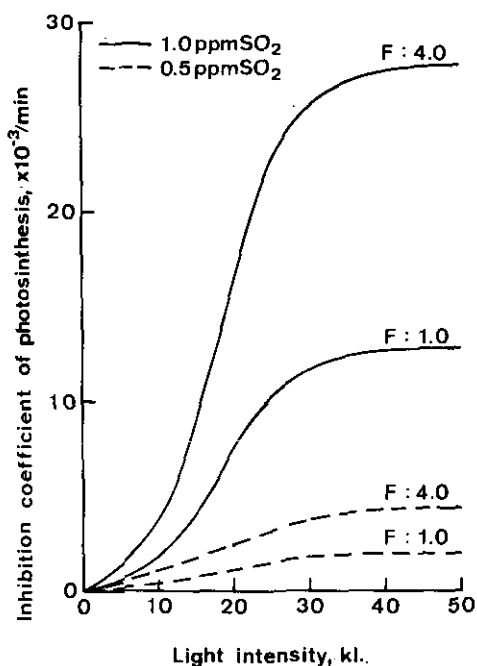

Fig. 9. Changes of the inhibition coefficient,  $b_1$ , with light intensity in sunflower leaves at the 1st and the 4th LAI within the foliage canopy under fumigation at 0.5 and 1.0 ppm SO<sub>2</sub>. Calculations were performed after equations (7) and (8).

1)  $b_2$  is equal to  $b_1$ , when  $b_1$  is smaller than  $2.5 \times 10^{-3}$  (equation (8) is applicable for calculating both coefficients)

2)  $b_2$  is  $2/9$  that of  $b_1$ , when  $b_1$  is larger than  $2.5 \times 10^{-3}$ ;  $b_2$  can be calculated by multiplying the value of  $b_1$  obtained from equation (8) by  $2/9$ .

Based on the above mentioned relationships between  $b_1$  and  $b_2$ , the canopy photosynthesis rate inhibited by SO<sub>2</sub>,  $P_s^c$ , can be calculated as a function of the incident light intensity, LAI and fumigation time, as shown by equation (9) (based on equation (1)). That is, if  $b_1 < 2.5 \times 10^{-3}/\text{min}$  and  $b_1 = b_2 = b$ ,

$$P_s^c = \int_0^F a P_o \exp(-bt) dF \quad (9a)$$

and if  $b_1 \geq 2.5 \times 10^{-3}/\text{min}$  and  $b_2 = b_1 \times 2/9$ ,

$$P_s^c = \int_0^F a P_o \exp(-b_1 \times 30) \exp[-b_1 \times \frac{2}{9}(t-30)] dF \quad (9b)$$

where  $P_o$  is expressed by equation (2) including equation (3), and  $b_1$  is expressed by equation (8) where  $K_m$  is substituted by equation (7). The value of  $a$  in equations (9a) and (9b), which corresponds to that of equation (1), can be approximated as 1.0. Therefore, the relative rate of canopy photosynthesis inhibited by SO<sub>2</sub> fumigation can be calculated as the ratio of equation (9) to equation (4). The solution of equation (9) was calculated numerically using Newton-Cotes' function. For the calculation of the canopy photosynthesis of sunflower populations using equation (9), the following constants were used:  $A$  and  $B$  in equation (2) were 0.1476 and 0.1117, respectively and were obtained from the graph in Fig. 6.  $R$  in equation (8) was  $0.067 \text{ mg CO}_2/\text{dm}^2/\text{min}$ .  $K$  and  $m$  in

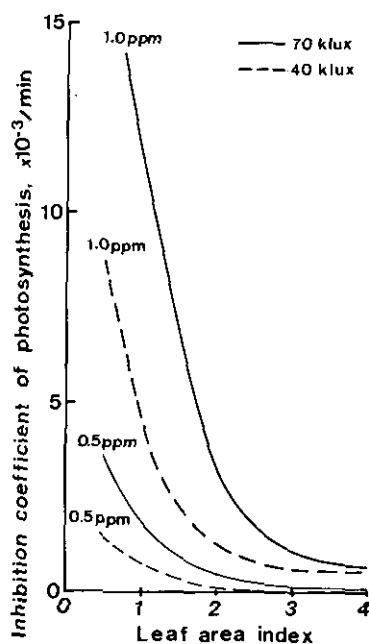

Fig. 10. The estimated inhibition coefficient,  $b_1$ , of sunflower leaves within the foliage canopy where mutual shading of leaves occurs. Incident light intensity above the canopy at 40 klx (broken lines) and 70 klx (continuous lines). Fumigation with  $\text{SO}_2$  was done at 0.5 and 1.0 ppm.

equation (8) were 0.9 and 0.1, which were determined from data reported by Shimizu and Totsuka (7).

Figs. 11 and 12 show changes in the canopy photosynthesis of sunflower foliage (LAI = 4) in different light intensities and  $\text{SO}_2$  concentrations, when the fumigation time is 60 min. It was indicated that when the  $\text{SO}_2$  concentration was below 0.2 ppm, the inhibition of canopy photosynthesis will be negligible, regardless of light intensity (e.g. 1% inhibition at 70 klx and 0.2 ppm  $\text{SO}_2$ ). On the other hand, at higher  $\text{SO}_2$  concentrations than 0.4 ppm, the inhibition of canopy photosynthesis will reach 7% at 20 klx and 13% at 40 klx for 1.0 ppm  $\text{SO}_2$  fumigation for 60 min. Fig. 13 shows that longer durations of fumigation will increase the inhibition of photosynthesis even at lower concentrations of  $\text{SO}_2$ . For example, at 0.4 ppm  $\text{SO}_2$  for 5 hrs. and 10 hrs. fumigations at 40 klx light intensity, the canopy photosynthesis of foliage with LAI of 4 will be decreased to 92% and 84% of the control value, while at 0.2 ppm  $\text{SO}_2$  the photosynthesis will be decreased to 98% and 97%, respectively. Inhibitory effects of  $\text{SO}_2$  on canopy photosynthesis are also dependent on the magnitude of LAI. As shown in Fig. 14, the inhibition rate will be increased with decrease of the LAI below 4.0, especially remarkably for high  $\text{SO}_2$  concentrations above 0.4 ppm. This suggests that the resistance of sunflower plants to  $\text{SO}_2$  fumigation with regards to canopy photosynthesis will be much increased for higher planting densities with larger LAIs.

Model for estimating SO<sub>2</sub> effects on photosynthesis

The author thanks Dr. Akio Furukawa, one of our colleagues in the National Institute for Environmental Studies, for permission to use of his data on photosynthesis measurements in sunflower plants.

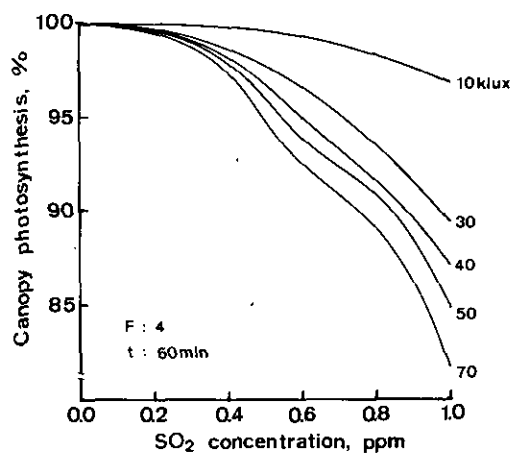

Fig. 11. Variation in the canopy photosynthesis with LAI of 4 under SO<sub>2</sub> fumigation for 60 min. in different light intensities. The photosynthesis rate in the ordinate is the percent of the control value. Calculations using equations (4) and (9).

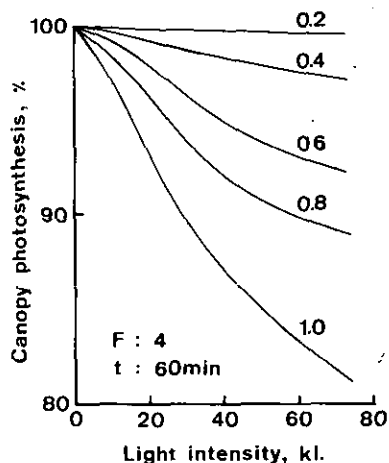

Fig. 12. The same data as in Fig. 11, but plotted against light intensity. Numerals in the figure show SO<sub>2</sub> concentrations in ppm.

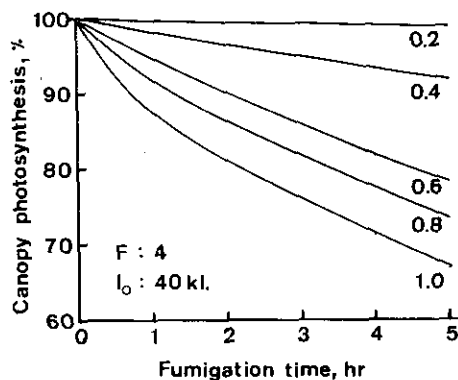

Fig. 13. Time trends of canopy photosynthesis rate of sunflower foliage with LAI of 4 under fumigations with different SO<sub>2</sub> concentrations (numerals in the figure). Incident light intensity above the canopy was 40 klx.

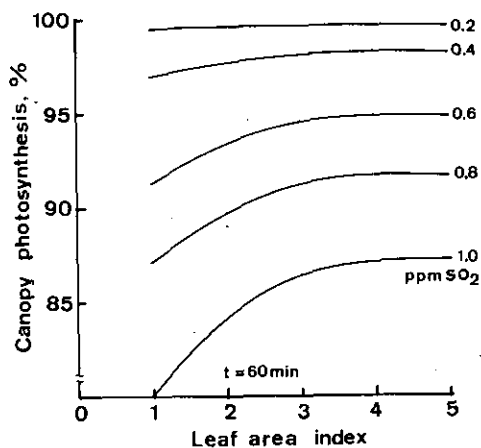

Fig. 14. Effects of fumigations with SO<sub>2</sub> for 60 min. on canopy photosynthesis with different LAIs.

References

1. Furukawa, A. and T. Totsuka: Effect of sulfur dioxide on net photosynthesis and stomatal aperture in sunflower leaves. *Rep. of Spec. Res. Project of the National Inst. for Environ. Studies*, No. 2: 57-66 (1978).
2. Kasanaga, H. and M. Monsi: On the light-transmission of leaves, and its meaning for the production of matter in plant communities. *Jap. J. Bot.* 14: 304-324 (1954).
3. Matsuoka, Y.: Experimental studies of sulfur dioxide injury to rice plants and its mechanism. *Spec. Bull. Chiba Agric. Exp. Stn.* No. 7, 63 pp. (1978).
4. Monsi, M. und T. Saeki: Über den Licht-faktor in den Pflanzengesellschaften und seine Bedeutung für die Stoffproduktion. *Jap. J. Bot.* 13: 22-52 (1953).
5. Ohshima, Y., T. Ushijima and T. Tazaki: Effects of atmospheric SO<sub>2</sub> on the photosynthetic and transpiratory rate of *Helianthus annuus* L. *Environ. Control in Biol.* 11: 103-108 (1973).
6. Saeki, T.: Interrelationships between leaf amount, light distribution and total photosynthesis in a plant community. *Bot. Mag. Tokyo* 73: 55-63 (1960).
7. Shimizu, H. and T. Totsuka: Estimation of SO<sub>2</sub> absorption rate of sunflower population. *Res. Rep. from the National Inst. for Environ. Studies* No. 11: 9-17 (1980).
8. Sij, J.W. and C.A. Swanson: Short-term kinetic studies on the inhibition of photosynthesis by sulfur dioxide. *J. Environ. Quality* 3: 103-107 (1974).
9. Taniyama, T.: Studies on the development of symptoms and the mechanism of injury caused by sulfur dioxide in crop plants. *Bull. Fac. of Agric. Mie Univ.* 44: 11-130 (1972).
10. Thomas, M.D. and G.R. Hill: Relation of sulfur dioxide in the atmosphere to photosynthesis and respiration of alfalfa. *Plant Physiol.* 12: 309-383 (1937).
11. Thomas, M.D.: Gas damage to plants. *Ann. Rev. Plant Physiol.* 2: 293-322 (1951).
12. Thomas, M.D.: Effects of air pollution on plant. In "Air pollution", *WHO Monograph* No. 46: 233-278 (1961).

## Absorption of atmospheric NO<sub>2</sub> by plants and soils V. Day and night NO<sub>2</sub>-fumigation effect on the plant growth and estimation of the amount of NO<sub>2</sub>-nitrogen absorbed by plants<sup>a</sup>

Tadakatsu Yoneyama<sup>1</sup>, Tsumugu Totsuka<sup>1</sup>, Naomi Hayakawa<sup>2</sup> and Jinya Yazaki<sup>2</sup>

<sup>1</sup> Division of Environmental Biology, The National Institute for Environmental Studies,  
Yatabe, Ibaraki 305

<sup>2</sup> Department of Agricultural Chemistry, Nihon University, Setagaya-ku, Tokyo 154

During 2 weeks of vegetative growth stages of sunflower, corn, kidney bean, cucumber, tomato and swiss chard plants grown in potted soil, the plants were exposed to 0.3 volppm NO<sub>2</sub> in naturally-lit growth cabinets (25°C, R.H. 70%) in the daytime (7:00–15:00) or in the nighttime (19:00–5:00) for 10 hours every day. The investigation of the effect of NO<sub>2</sub> fumigation on plant growth and the estimation of NO<sub>2</sub>-nitrogen absorbed in the plants was carried out in early summer. Daytime fumigation significantly increased the leaf-area and dry-weight of cucumber plants. Nighttime fumigation resulted in the stimulation of growth in sunflower, kidney bean and cucumber plants, while it caused depression of growth in corn plant. No significant effect of NO<sub>2</sub> fumigation was found in tomato and swiss chard plants.

The amount of the soil- and fertilizer-nitrogen taken up by plants was calculated in the NO<sub>2</sub>-fumigated plants by adding <sup>15</sup>N-labeled (NH<sub>4</sub>)<sub>2</sub>SO<sub>4</sub> to the soil, and the rest of the plant nitrogen was considered as NO<sub>2</sub>-nitrogen absorbed in the plants. Using these data, NO<sub>2</sub> absorbing activity (dry-weight and leaf-area basis) of plants was calculated. Sunflower, tomato and swiss chard plants had high activity, but corn plant was found to have very low activity. The daytime activity was around twice that for nighttime. NO<sub>2</sub>-nitrogen was greatly distributed in the leaves, indicating that the leaf is a main NO<sub>2</sub> absorbing site. The equation proposed by Fried and Middelboe (4) to measure the amount of fixed nitrogen by legume crops was found to be a useful equation in measuring the NO<sub>2</sub>-nitrogen absorbed by plants. The contribution of NO<sub>2</sub>-nitrogen in the increase of plant nitrogen during growth was estimated to be 8-23% at 0.3 ppm NO<sub>2</sub>, and 1-3% at 0.03 ppm.

**Key words:** Air pollution – Day and Night – <sup>15</sup>N – Nitrogen dioxide – Plant growth – Soil-grown plants

The concentration of atmospheric NO<sub>2</sub> is increasing year by year through human activities. The plants and their canopies are believed to be a sink for atmospheric NO<sub>2</sub> (6). A previous investigation confirmed that the nitrogen coming from NO<sub>2</sub> could be used

- a. A part of this report was presented to the annual meeting of the society of the science of soil and manure, Japan (Sapporo, 1979)

in producing plant proteins (18). It has been observed that higher plants, kept in a closed box, could reduce the NO<sub>2</sub> concentration of the box atmosphere to less than 0.01 ppm NO<sub>2</sub>, when they were fumigated with 0.1–10 ppm NO<sub>2</sub> (17). The system for transformation of NO<sub>2</sub> may give the plants the capacity of continuous NO<sub>2</sub> absorption.

In order to know the amount of NO<sub>2</sub> absorbed by plants, we conducted an experiment where test plants were cultured in water; the nitrogen coming from the medium was distinguished from NO<sub>2</sub>-nitrogen by labeling with <sup>15</sup>N (9). This work has

Table 1 *Outline of experiments*

Exp. 1 (sunflower, corn, kidney bean)

Date

- 1978,5,19 One kg of air-dried soil per pot was transferred, and 100 pots were prepared for each plant species. Around 200 ml of water was added to each pot, and thereafter every day during experimental period, appropriate amount of water was supplied at 17:00–18:00.
- 5,23 The seeds were sterilized by steeping in 0.1% usuplun solution for 1 hour, washed by tap water, and kept in tap water for one night.
- 5,24 Four seeds per pot were sown, and the planted pots were kept in naturally-lit chambers (25°C, R.H 75%).
- 5,29 The seedlings were thinned, remaining two healthy seedlings per pot.
- 6, 1 Uniform seedlings having similar height and leaf area were selected, and around 80 pots having one seedling per pot were prepared for each plant species.
- 6, 5 0.766 g of KH<sub>2</sub>PO<sub>4</sub> and 0.620 g of (<sup>15</sup>NH<sub>4</sub>)<sub>2</sub>SO<sub>4</sub> (4.70 atom % excess <sup>15</sup>N) were added to a pot in 10 ml solution.
- 6, 7 The potted plants were divided into four groups, and each group consisted of around 20 plants for each species. One group was sampled as 4 replicates (one replicate consisted of 5 plants), separating into the leaf, the stem and the root. In the case of corn, the shoot was separated into the leaf blade and the leaf sheath. The root sample was obtained after washing by tap water within the sampling day. All samples were dried at 90°C for 4 days. The other plants (3 groups) were grown for a further 2 weeks. One group was fumigated with 0.3 ppm during daytime (7:00–17:00), and the second group was fumigated with NO<sub>2</sub> at the same concentration during nighttime (19:00–5:00). The third group was kept without NO<sub>2</sub> fumigation.
- 6,21 NO<sub>2</sub> fumigation was stopped, and the plants were sampled as mentioned above.

Exp. 2 (cucumber, tomato, swiss chard)

Date

- 1878,6,23 Preparation of the soil (1 kg per pot)
- 6,24 Sterilization of the seeds
- 6,25 Sowing the seeds. (4 seeds per pot)
- 6,28 Thinning the plants to 2 seedlings per pot.
- 7, 5 Further thinning to 1 seedling per pot and selection of uniform seedlings.
- 7, 7 Application of KH<sub>2</sub>PO<sub>4</sub> (0.766 g per pot) and (<sup>15</sup>NH<sub>4</sub>)<sub>2</sub>SO<sub>4</sub> (0.652 g per pot, 4.96 atom % excess <sup>15</sup>N) solution (10 ml per pot)
- 7,10 The plants were grouped into 4, and NO<sub>2</sub> treatment was started in the same manner as Exp. 1.  
Initial sample was obtained.
- 7,24 NO<sub>2</sub> treatment was stopped, and the plant samples were obtained.

now been extended to the experiments using soil-grown plants with fumigation during daytime and nighttime separately. The amount of NO<sub>2</sub>-nitrogen absorbed by plants was estimated together with an investigation on the effect of day and night NO<sub>2</sub> fumigation on plant growth.

### Materials and methods

The soil was obtained from the upland field in Ibaraki, slightly air-dried (30% water), and passed through a 2-mm sieve. Carbon and nitrogen content was 3.79%, and 0.259% oven-dried basis (100°C, 1 hour) and the pH (water) was 5.8. One pot held 1 Kg soil with the surface area of 100 cm<sup>2</sup>. The seeds of sunflower (*Helianthus annuus* L. c.v. Russian Mammoth), corn (*Zea mays* L. c.v. Dento), Kidney bean (*Phaseolus vulgaris* L. c.v. Shin-edogawa), cucumber (*Cucumis sativus* L.), tomato (*Lycopersicon esculentum* Mill c.v. Fukuju No. 2), and swiss chard (*Beta vulgaris* L. var. Cicla L.) were obtained from the stock room of the phytotron of the National Institute for Environmental Studies. The outline of experiments are described in Table 1.

Naturally-lit gas cabinets (Koito K.K., S-200 type) were set at the uppermost floor facing to the south. The design of the gas exposure facilities is shown in Fig. 1. The base area was 2 × 2 m<sup>2</sup>, and the volume used for plant fumigation was approximately 10 m<sup>3</sup>. The air in the cabinet was exchanged 6 times per hour. Clean air was obtained by filtering fresh air through activated carbon and manganese powder. NO<sub>2</sub> gas was added to the incoming air, this mixture was directed up from the floor through a stainless steel net having many small pores. The concentration of NO<sub>2</sub> in the cabinets was continuously monitored by NO<sub>x</sub> analyzer (Thermo Electron Co. 14D), and controlled by a feedback system to maintain a constant concentration (0.3 volppm). Pure NO<sub>2</sub> gas (purchased from Seitetsu-Kagaku, Tokyo) stored in a pressurized cylinders containing 0.6% NO<sub>2</sub> with 99.4% N<sub>2</sub> was introduced into the cabinets. Some NO, less than 10% of the NO<sub>2</sub> concentration, was produced under the strong radiation of the summer sunshine. No significant ozone was detectable. The environment in the cabinets was; Air temperature: 25 ± 2°C, Relative humidity: 70 ± 5%, Radiation: 50% intensity of natural sunlight.

Before treatments, test plants were grown in NO<sub>2</sub>-free air. For the experiments they were separated into 4 groups, each with 20 plants of each species. One group was sampled

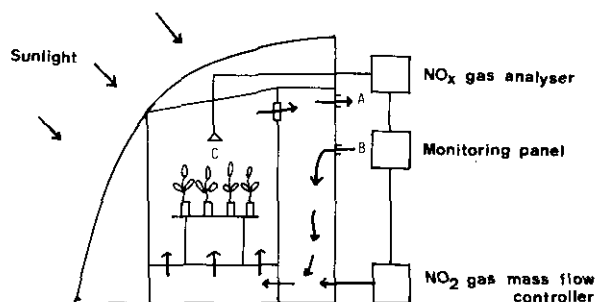

Fig. 1. Design for NO<sub>2</sub> gas fumigation cabinets

- A. Outlet for air filtered by activated carbon and manganese filter.
- B. Inlet for air filtered by activated carbon and manganese filter.
- C. Gas sampling

at the start of the experiment to obtain the initial leaf area, dry weight and nitrogen content for each plant species. Each of the other groups was placed into one of 3 fumigation cabinets for daytime fumigation, nighttime fumigation and control, respectively. At the end of 2 weeks the plants were sampled. Most samples contained 4 replicates, each replicate was comprised of 5 plants. The leaf area was measured by planimetric leaf area meter immediately after separation of the plants into plant parts. After drying in an oven, dry weight, nitrogen content and  $^{15}\text{N}$  content of each part were measured as described previously (9). Significance of the treatments was examined by t-test.

## Results

### *Effects on the growth*

No visible injury by  $\text{NO}_2$  fumigation appeared on the leaves of any plants. Invisible effects were examined concerning the leaf-area increase (Table 2) and the dry-weight increase (Table 3). According to t-test, 10 hours' fumigation during daytime for 14 days caused a significant stimulation of the increase in leaf area in cucumber plants. Similar results were observed with nighttime fumigation of sunflower, kidney bean and cucumber plants. Nighttime fumigation depressed the rate of increase in leaf area of corn plants. Treated tomato plants also failed to show as large leaf-area increase as plants in the control but the results were not significant.  $\text{NO}_2$  fumigation had positive or negative effects on the dry-weight increase of some plants similar to that observed for the leaf area (Table 3). Daytime fumigation had a positive effect on cucumber plant, and nighttime fumigation had a positive effect on sunflower, kidney bean, and cucumber plants, and negative effect on corn plants. The results of nitrogen analysis for different plant parts are summarized in Table 4. Daytime fumigation brought about increase of nitrogen in the leaves of cucumber, and kidney bean plants, and a decrease of nitrogen in the leaf and stem of corn plants compared with the nitrogen in non-fumigated plants (control). Nighttime fumigation brought about an increase of nitrogen in sunflower, kidney bean, and cucumber plants, and a decrease in corn plants. Significantly positive affections were observed in the roots in kidney bean and cucumber plants, and in the leaf in sunflower plant.

Table 2 *Effect of daytime and nighttime  $\text{NO}_2$  fumigation on the leaf-area of 6 plant species<sup>a</sup>*

Plant	Initial	After 2 weeks		
		Control	Daytime fumigation	Nighttime fumigation
Sunflower	340	2350	2430 (103) <sup>b</sup>	3070 (131) <sup>**c</sup>
Corn	540	4150	4050 ( 98)	3480 ( 84) <sup>*c</sup>
Kidney bean	860	3760	3840 (102)	4630 (123) <sup>**</sup>
Cucumber	600	2910	3610 (124) <sup>**</sup>	3330 (114) <sup>*</sup>
Tomato	90	2120	1940 ( 92)	1960 ( 92)
Swiss chard	50	1510	1440 ( 95)	1460 ( 97)

a, Each plant is composed of 5 individuals, and the leaf area is indicated in  $\text{cm}^2$  as the average of 3 or 4 replicates.

b, The numerals in the parentheses are relative values to control (100).

c, Significantly differed from control at 5% (\*) and 1% (\*\*) levels, respectively.



NO<sub>2</sub> absorption by plants and soils (V)

Table 3 *Effect of daytime and nighttime NO<sub>2</sub> fumigation on the dry-weight increase of 6 plant species<sup>a</sup>*

Plant	Plant part	Initial	After 2 weeks		
			Control	Daytime fumigation	Nighttime fumigation
Sunflower	Leaf	0.89	6.56	6.48 ( 99) <sup>b</sup>	7.26 (111) <sup>*c</sup>
	Stem	0.59	6.70	6.04 ( 90)	7.96 (119) <sup>*</sup>
	Root	0.23	2.74	2.65 ( 97)	2.86 (104)
	Total	1.71	16.00	15.17 ( 95)	18.08 (113) <sup>*</sup>
Corn	Leaf blade	0.99	9.66	9.15 ( 95)	7.89 ( 82) <sup>*</sup>
	Leaf sheath	0.59	5.61	4.71 ( 84)	4.27 ( 76) <sup>*</sup>
	Root	0.98	6.04	5.79 ( 96)	5.61 ( 93)
	Total	2.53	21.31	19.65 ( 92)	17.77 ( 83)
Kidney bean	Leaf	1.77	7.52	7.94 (106)	8.22 (109)
	Stem	1.26	5.22	4.57 ( 88)	6.22 (119) <sup>**</sup>
	Root	0.83	3.53	3.20 ( 91)	4.44 (126) <sup>**</sup>
	Total	3.86	16.27	15.71 ( 97)	18.88 (116) <sup>**</sup>
Cucumber	Leaf	1.56	11.51	14.24 (124) <sup>**</sup>	12.25 (106) <sup>*</sup>
	Stem	0.29	3.46	5.09 (147) <sup>**</sup>	4.33 (125) <sup>*</sup>
	Root	0.23	2.88	3.25 (113) <sup>*</sup>	3.13 (109) <sup>*</sup>
	Total	2.08	17.85	22.68 (127) <sup>**</sup>	19.71 (110) <sup>**</sup>
Tomato	Leaf	0.19	5.17	5.14 ( 99)	5.06 ( 98)
	Stem	0.07	3.15	3.14 (100)	3.03 ( 96)
	Root	0.02	1.19	1.04 ( 87)	1.28 (108)
	Total	0.28	9.51	9.32 ( 98)	9.37 ( 99)
Swiss chard	Shoot	0.14	5.23	5.70 (109)	5.32 (102)
	Root	0.04	1.07	1.27 (119)	1.23 (115)
	Total	0.18	6.30	6.97 (110)	6.55 (104)

a. Each plant sample is composed of 5 individuals. Dry-weight is indicated in g as the average of 3 or 4 replicates.

b.c. See the footnotes of Table 2.

*Nitrogen distribution in plants*

The nitrogen in the plants had four sources, soil, seed, fertilizer (<sup>15</sup>N-labeled (NH<sub>4</sub>)<sub>2</sub>SO<sub>4</sub>) and atmospheric NO<sub>2</sub>. Distribution of nitrogen from the soil (including seed) and fertilizer in the plants was calculated from the following equations, with some assumptions, and summarized in Table 5 to 10.

$$FN = TN \times \frac{B}{D} \tag{1}$$

where

FN = total amount of the nitrogen derived from fertilizer in the plant part,

TN = total nitrogen in the plant part,

B = atom percent excess <sup>15</sup>N of the plant part, and

D = atom percent excess <sup>15</sup>N in the applied fertilizer ((NH<sub>4</sub>)<sub>2</sub>SO<sub>4</sub>).

Sum (SN) of soil, seed and NO<sub>2</sub> nitrogen in the plant part is obtained

$$SN = TN - FN \tag{2}$$

Table 4 *Effect of daytime and nighttime NO<sub>2</sub> fumigation on the increase in total nitrogen in 6 plant species<sup>a</sup>*

Plant	Plant part	Initial	After 2 weeks		
			Control	Daytime fumigation	Nighttime fumigation
Sunflower	Leaf	32.0	348.7	397.4 (114) <sup>b</sup>	437.3 (125)** <sup>c</sup>
	Stem	7.2	122.5	126.8 (104)	124.1 (101)
	Root	4.7	65.1	58.3 ( 90)	64.3 ( 99)
	Total	43.9	536.3	582.5 (109)	625.6 (117)**
Corn	Leaf blade	24.3	317.4	290.3 ( 91)* <sup>c</sup>	286.8 ( 90)*
	Leaf sheath	11.7	151.8	117.2 ( 77)*	116.8 ( 77)*
	Root	13.1	109.2	107.2 ( 98)	94.6 ( 87)
	Total	49.1	578.4	514.7 ( 89)*	498.1 ( 86)*
Kidney bean	Leaf	60.7	368.9	429.5 (116)*	419.9 (114)
	Stem	15.1	144.5	121.5 ( 84)	142.3 ( 98)
	Root	20.8	83.9	79.3 ( 95)	103.3 (123)*
	Total	96.6	597.3	630.3 (106)	665.4 (111)**
Cucumber	Leaf	74.1	409.3	501.9 (123)**	439.3 (107)
	Stem	13.5	152.0	169.4 (111)*	168.8 (111)
	Root	8.4	92.7	102.7 (111)	111.9 (121)**
	Total	96.0	654.0	774.0 (118)**	720.0 (110)*
Tomato	Leaf	10.0	309.7	307.3 ( 99)	290.3 ( 94)
	Stem	2.7	126.0	127.2 (101)	109.6 ( 87)
	Root	0.7	41.1	36.1 ( 88)	42.7 (104)
	Total	13.4	476.8	470.5 ( 99)	442.6 ( 93)
Swiss chard	Shoot	7.5	318.3	343.1 (108)	310.9 ( 98)
	Root	1.6	42.7	51.0 (119)	43.7 (102)
	Total	9.1	361.0	394.1 (109)	365.1 (101)

a, Each plant sample is composed of 5 individuals. Total nitrogen is indicated in mg as the average of 3 or 4 replicates.

b,c, See the footnotes of Table 2.

In these tables, the increases of total, fertilizer and soil (including seed and NO<sub>2</sub>) nitrogen during 2 weeks in the nonfumigated (control), daytime fumigated, and nighttime fumigated plants are also shown as  $\Delta$ TN,  $\Delta$ FN and  $\Delta$ SN.

$$\Delta$$
TN = (TN in the treated plant) – (TN at initial sampling)

$$\Delta$$
FN = (FN in the treated plant) – (FN at initial sampling) (3)

$$\Delta$$
SN = (SN in the treated plant) – (SN at initial sampling)

The increase of soil nitrogen in fumigated plants (SN') was calculated with following three assumptions.

- Seed nitrogen did not contribute to the increase of nitrogen after the initial sampling time.
- Redistribution of the nitrogen presented at the initial sampling time in different plant parts did not occur during the period of treatments.
- During 2 weeks of treatment, soil nitrogen is absorbed by different plant parts

NO<sub>2</sub> absorption by plants and soils (V)

together with fertilizer nitrogen, and the ratios, soil nitrogen to fertilizer nitrogen absorbed in the fumigated plants are equal to those in the control plants.

$$\Delta SN' = (\Delta FN \text{ in fumigated plant}) \times \frac{\Delta SN \text{ in control plant}}{\Delta FN \text{ in control plant}} \quad (4)$$

*Estimation of absorbed NO<sub>2</sub> nitrogen in plants*

Three methods were employed for the calculation to estimate the amount of NO<sub>2</sub>-nitrogen in different parts of the fumigated plants, and shown in Table 11 to 16.

A) Difference of  $\Delta TN$  in the plant parts between the fumigated plants and control plants.

B) Difference of  $\Delta SN$  in the plant parts between the fumigated plants and control plants.

In fumigated plant,  $\Delta SN$  is composed of soil and NO<sub>2</sub> nitrogen, while it is composed of only soil nitrogen in control plants.

C) Difference of  $\Delta SN$  and  $\Delta SN'$  in the plant parts of the fumigated plants.

As discussed later under "Discussion", method C gave most probable values. The percentage increase of the NO<sub>2</sub>-nitrogen estimated by method C during 2 weeks is shown in the last column of Table 11 to 16.

Table 5 Nitrogen distribution in sunflower plants<sup>a</sup>

Treatment	Plant part	TN (mg)	<sup>15</sup> N content (atom % excess)	FN <sup>b</sup> (mg)	SN <sup>c</sup> (mg)	Increase during 2 weeks (mg) <sup>d</sup>			
						$\Delta TN$	$\Delta FN$	$\Delta SN$	$\Delta SN'$
Initial	Leaf	32.0	0.77	5.2	26.8				
	Stem	7.2	1.37	2.1	5.1				
	Root	4.7	1.37	1.4	3.3				
	Total	43.9	—	8.7	35.2				
Control	Leaf	348.7	4.09	303.4	45.3	316.7	298.2	18.5	
	Stem	122.5	4.19	109.1	13.4	115.3	107.0	8.3	
	Root	65.1	3.74	51.8	13.3	60.4	50.4	10.0	
	Total	536.3	—	464.3	72.0	492.4	455.6	36.8	
Daytime fumigation	Leaf	397.4	3.54	299.2	98.2	365.4	294.0	71.4	18.2
	Stem	126.8	3.90	105.2	21.6	119.6	103.1	16.5	8.0
	Root	58.3	3.36	41.7	16.6	53.6	40.3	13.3	8.0
	Total	582.5	—	446.1	136.4	538.6	437.4	101.2	34.2
Nighttime fumigation	Leaf	437.3	3.83	356.4	80.9	405.3	351.2	54.1	21.8
	Stem	124.1	4.05	107.0	17.1	119.4	104.9	14.5	8.1
	Root	64.3	3.62	49.5	14.8	59.6	48.1	11.5	9.5
	Total	625.7	—	512.9	112.8	584.3	504.2	80.1	39.4

a, Value for 5 plants is indicated respectively.

b, Nitrogen derived from <sup>15</sup>N-labeled (NH<sub>4</sub>)<sub>2</sub>SO<sub>4</sub> applied to the soil.

c, Nitrogen derived from soil, seed and NO<sub>2</sub>.

d, Calculations of these values are explained in the text.

Table 6 Nitrogen distribution in corn plants<sup>a</sup>

Treatment	Plant part	TN (mg)	<sup>15</sup> N con- tent (atom % excess)	FN (mg)	SN (mg)	Increase during 2 weeks (mg)			
						ΔTN	ΔFN	ΔSN	ΔSN'
Initial	Leaf blade	24.3	0.14	2.1	22.2				
	Leaf sheath	11.7	1.54	3.8	7.9				
	Root	13.1	0.77	2.1	11.0				
	Total	49.1	—	8.0	41.1				
Control	Leaf blade	317.4	4.07	274.9	42.5	293.1	272.8	20.3	
	Leaf sheath	151.8	4.24	136.9	14.9	140.1	133.1	7.0	
	Root	109.2	3.54	82.2	27.0	96.1	80.1	16.0	
	Total	578.4	—	494.0	84.4	529.3	486.0	43.3	
Daytime fumi- gation	Leaf blade	290.3	3.81	235.4	54.9	266.0	233.3	32.7	17.4
	Leaf sheath	117.2	4.09	102.0	15.2	105.5	98.2	7.3	5.2
	Root	107.2	3.39	77.3	29.9	94.1	75.2	18.9	15.0
	Total	514.7	—	414.7	100.0	465.6	406.7	58.9	37.6
Nighttime fumi- gation	Leaf blade	286.8	3.92	239.2	47.6	262.5	237.1	25.4	17.6
	Leaf sheath	116.8	4.15	103.1	13.7	105.1	99.3	5.8	5.2
	Root	94.6	3.39	68.2	26.4	81.5	66.1	15.4	13.2
	Total	498.2	—	410.5	87.7	449.1	402.5	46.6	36.0

a, Value for 5 plants is indicated respectively.

Table 7 Nitrogen distribution in kidney bean plants<sup>a</sup>

Treatment	Plant part	TN (mg)	<sup>15</sup> N con- tent (atom % excess)	FN (mg)	SN (mg)	Increase during 2 weeks (mg)			
						ΔTN	ΔFN	ΔSN	ΔSN'
Initial	Leaf	60.7	0.41	5.3	55.4				
	Stem	15.1	0.73	2.3	12.8				
	Root	20.8	0.70	3.1	17.7				
	Total	96.6	—	10.7	85.9				
Control	Leaf	368.9	3.77	295.9	73.0	308.2	290.6	17.6	
	Stem	144.5	3.95	121.4	23.1	129.4	119.1	10.3	
	Root	83.9	3.09	55.1	28.8	63.1	52.0	11.1	
	Total	597.3	—	472.4	124.9	500.7	461.7	39.0	
Daytime fumi- gation	Leaf	422.0	3.37	308.0	114.0	361.3	302.7	58.6	18.3
	Stem	121.5	3.70	95.6	25.9	106.4	93.3	13.1	8.1
	Root	79.3	3.07	51.8	27.5	58.5	48.7	9.8	10.4
	Total	622.8	—	455.4	167.4	526.2	444.7	81.5	36.8
Nighttime fumi- gation	Leaf	419.9	3.58	320.0	99.9	359.2	314.7	44.5	19.1
	Stem	142.3	3.77	114.1	28.2	127.2	111.8	15.4	9.7
	Root	103.3	3.04	66.8	36.5	82.5	63.7	18.8	13.6
	Total	665.5	—	500.9	164.6	568.9	490.2	78.7	42.4

a, Value for 5 plants is indicated respectively.

NO<sub>2</sub> absorption by plants and soils (V)

Table 8 Nitrogen distribution in cucumber plants<sup>a</sup>

Treatment	Plant part	TN (mg)	<sup>15</sup> N content (atom % excess)	FN (mg)	SN (mg)	Increase during 2 weeks (mg)			
						ΔTN	ΔFN	ΔSN	ΔSN'
Initial	Leaf	74.1	0.40	6.0	68.1				
	Stem	13.5	0.53	1.4	12.1				
	Root	8.4	1.14	1.9	6.5				
	Total	96.0	—	9.3	86.7				
Control	Leaf	409.3	3.73	307.8	101.5	335.2	301.8	33.4	
	Stem	152.0	3.97	121.6	30.4	138.5	120.2	18.3	
	Root	92.7	3.80	71.0	21.7	84.3	69.1	15.2	
	Total	654.0	—	500.4	153.6	558.0	491.1	66.9	
Daytime fumigation	Leaf	501.9	3.35	338.8	163.1	427.8	332.8	95.0	36.8
	Stem	169.4	3.76	128.4	41.0	155.9	127.0	28.9	19.3
	Root	95.6	3.50	67.5	28.1	87.2	65.6	21.6	14.4
	Total	766.9	—	534.7	232.2	670.9	525.4	145.5	70.5
Nighttime fumigation	Leaf	439.3	3.62	320.7	118.6	365.2	314.7	50.5	34.8
	Stem	168.8	3.98	135.4	33.4	155.3	134.0	21.3	20.4
	Root	93.8	3.73	70.5	23.3	85.4	68.6	16.8	15.1
	Total	701.9	—	526.6	175.3	605.9	517.3	88.6	70.3

a, Value for 5 plants is indicated respectively.

Table 9 Nitrogen distribution in tomato plants<sup>a</sup>

Treatment	Plant part	TN (mg)	<sup>15</sup> N content (atom % excess)	FN (mg)	SN (mg)	Increase during 2 weeks (mg)			
						ΔTN	ΔFN	ΔSN	ΔSN'
Initial	Leaf	10.0	0.48	1.0	9.0				
	Stem	2.7	0.61	0.3	2.4				
	Root	0.7	1.22	0.2	0.5				
	Total	13.4	—	1.5	11.9				
Control	Leaf	309.7	3.21	200.4	109.3	299.7	199.4	100.3	
	Stem	126.0	3.41	86.6	39.4	123.3	86.3	37.0	
	Root	41.1	3.47	28.8	12.3	40.4	28.5	11.8	
	Total	476.8	—	315.8	161.0	463.4	314.3	149.1	
Daytime fumigation	Leaf	307.3	2.89	179.2	128.1	297.3	178.2	119.1	86.9
	Stem	127.2	3.19	81.8	45.4	124.5	81.5	43.0	34.9
	Root	36.1	3.28	23.9	12.2	35.4	23.7	11.7	9.8
	Total	470.6	—	284.9	185.7	457.2	283.4	173.8	131.6
Nighttime fumigation	Leaf	290.3	3.05	178.5	111.8	280.3	177.5	102.8	89.3
	Stem	109.6	3.40	75.1	34.5	106.9	74.8	32.1	32.1
	Root	42.7	3.44	29.6	13.1	42.0	29.9	12.6	12.2
	Total	442.6	—	283.2	159.4	429.2	281.7	147.5	133.6

a, Value for 5 plants is indicated respectively.

Table 10 Nitrogen distribution in swiss chard plants<sup>a</sup>

Treatment	Plant part	TN (mg)	<sup>15</sup> N con- tent (atom % excess)	FN (mg)	SN (mg)	Increase during 2 weeks (mg)			
						ΔTN	ΔFN	ΔSN	ΔSN'
Initial	Shoot	7.5	0.29	0.4	7.1				
	Root	1.6	0.56	0.2	1.4				
	Total	9.1	—	0.6	8.5				
Control	Shoot	318.3	3.37	216.1	102.2	310.8	215.7	95.1	
	Root	42.7	3.55	30.6	12.1	41.1	30.4	10.7	
	Total	361.0	—	246.7	114.3	351.9	246.1	105.8	
Daytime fumi- gation	Shoot	343.1	3.11	215.1	128.0	335.6	214.7	120.9	94.7
	Root	51.0	3.26	33.5	17.5	49.4	33.3	16.1	11.7
	Total	394.1	—	248.6	145.5	385.0	248.0	137.0	106.4
Nighttime fumi- gation	Shoot	310.9	3.26	204.3	106.6	303.4	203.9	99.5	89.9
	Root	43.7	3.33	29.3	14.4	42.1	29.1	13.0	10.2
	Total	354.6	—	233.6	121.0	345.5	233.0	112.5	100.1

a, Value for 5 plants is indicated respectively.

Table 11 Estimation of absorbed NO<sub>2</sub> nitrogen in sunflower plants<sup>a</sup>

Treatment	Plant part	Difference from Control (mg)		ΔSN-ΔSN' (mg)	% of ΔTN
		in ΔTN	in ΔSN		
Daytime fumigation	Leaf	48.7	52.9	53.2	14.6
	Stem	-4.3	8.2	8.5	7.1
	Root	-6.8	3.3	5.3	9.9
	Total	42.6	64.4	67.0	12.4
Nighttime fumigation	Leaf	88.6	35.6	32.3	8.0
	Stem	4.1	6.2	6.4	5.4
	Root	-0.8	1.5	2.0	3.4
	Total	91.9	43.3	40.7	7.0

a, Value of 5 plants is indicated respectively.

## Discussion

### Fumigation effects on plant growth

Chronic effect of the fumigation of air pollutants at low concentration (less than 0.5 ppm) on plants are sometimes tested by their dry-weight changes during exposure periods because visible injury usually does not appear (5, 9, 12, 13, 15). Results in the investigation of low concentrations NO<sub>2</sub> fumigation on plant growth fluctuates among species, and among experimental conditions. Even in one species, no definite trends have been obtained. Taylor and Eaton (13) reported that continuous exposure of NO<sub>2</sub> at 0.15–0.21 ppm during 10–22 days resulted in reduction of growth (dry weight) in tomato plants. Spierings (12) also stated that fumigation with 0.25 ppm NO<sub>2</sub> during the entire

NO<sub>2</sub> absorption by plants and soils (V)

Table 12 *Estimation of absorbed NO<sub>2</sub> nitrogen in corn plants<sup>a</sup>*

Treatment	Plant part	Difference from Control (mg)		ΔSN-ΔSN' (mg)	% of ΔTN
		in ΔTN	in ΔSN		
Daytime fumigation	Leaf blade	-27.1	12.4	15.3	5.8
	Leaf sheath	-34.6	0.3	2.1	2.0
	Root	- 2.0	2.9	3.9	4.1
	Total	-63.7	15.6	21.3	4.6
Nighttime fumigation	Leaf blade	-30.6	5.1	7.8	3.0
	Leaf sheath	-35.0	- 1.2	0.6	0.6
	Root	-14.6	- 0.6	2.2	2.7
	Total	-80.2	5.3	10.6	2.4

a, Value of 5 plants is indicated respectively

Table 13 *Estimation of absorbed NO<sub>2</sub> nitrogen in kidney bean plants<sup>a</sup>*

Treatment	Plant part	Difference from Control (mg)		ΔSN-ΔSN' (mg)	% of ΔTN
		in ΔTN	in ΔSN		
Daytime fumigation	Leaf	53.1	41.0	40.3	9.5
	Stem	-23.0	2.8	5.0	4.7
	Root	- 4.6	- 1.3	- 0.6	-
	Total	25.5	42.5	44.7	7.2
Nighttime fumigation	Leaf	51.0	26.9	25.4	7.1
	Stem	- 2.2	5.1	5.7	4.5
	Root	19.4	7.7	5.2	6.3
	Total	68.2	39.7	36.3	6.4

a, Value of 5 plants is indicated respectively.

Table 14 *Estimation of absorbed NO<sub>2</sub> nitrogen in cucumber plants<sup>a</sup>*

Treatment	Plant part	Difference from Control (mg)		ΔSN-ΔSN' (mg)	% of ΔTN
		in ΔTN	in ΔSN		
Daytime fumigation	Leaf	92.6	61.6	58.2	13.6
	Stem	17.4	10.6	9.6	6.2
	Root	2.9	6.4	8.2	9.4
	Total	112.9	78.6	76.0	11.3
Nighttime fumigation	Leaf	30.0	17.1	15.7	4.3
	Stem	16.8	3.0	0.9	0.6
	Root	1.1	1.6	1.1	1.3
	Total	47.9	21.7	17.7	2.9

a, Value of 5 plants is indicated respectively. -

Table 15 Estimation of absorbed  $\text{NO}_2$  nitrogen in tomato plants<sup>a</sup>

Treatment	Plant part	Difference from Control (mg)		$\Delta\text{SN}-\Delta\text{SN}'$ (mg)	% of $\Delta\text{TN}$
		in $\Delta\text{TN}$	in $\Delta\text{SN}$		
Daytime fumigation	Leaf	- 2.4	18.8	32.2	10.8
	Stem	1.2	6.0	8.1	6.5
	Root	- 5.0	- 0.1	1.9	5.4
	Total	- 6.2	24.7	42.2	9.2
Nighttime fumigation	Leaf	-19.4	2.5	13.5	4.8
	Stem	-16.4	- 4.9	0.0	0
	Root	1.6	0.8	0.4	1.0
	Total	-34.2	- 1.6	13.9	3.2

a, Value of 5 plants is indicated respectively.

Table 16 Estimation of absorbed  $\text{NO}_2$  nitrogen in swiss chard plants<sup>a</sup>

Treatment	Plant part	Difference from Control (mg)		$\Delta\text{SN}-\Delta\text{SN}'$ (mg)	% of $\Delta\text{TN}$
		in $\Delta\text{TN}$	in $\Delta\text{SN}$		
Daytime fumigation	Shoot	24.8	25.8	26.2	7.8
	Root	8.3	5.4	4.4	8.9
	Total	33.1	31.2	30.6	7.9
Nighttime fumigation	Shoot	- 7.4	4.4	9.6	3.2
	Root	1.0	2.3	2.8	6.7
	Total	- 6.4	6.7	12.4	3.6

a, Value of 5 plants is indicated respectively.

growth period depressed the rate of increase in dry weight in tomato plants by 41% over that for non-fumigated plants. On the contrary, Troiano and Leone (15) reported that fumigation with 0.23 ppm  $\text{NO}_2$  for 80 h or with 0.37 ppm for 164 h stimulated an increase in dry-weight in tomato plants when the test plants were prepared in a sand culture containing 140 mg  $\text{NO}_3\text{-N l}^{-1}$ . The differences in their results may attribute to the differences in plant variety, age, nutritional status, and environmental factors (temperature, light intensity, humidity, and so on). In the present experiment,  $\text{NO}_2$  fumigation gave stimulative effect on the increase of dry-weight and leaf-area in cucumber plants. The growth of rice plant grown in the submerged soil was positively affected by  $\text{NO}_2$  fumigation at 0.3 or 0.6 ppm (5).

Another aspect of the fumigation effect is the change in nitrogen content. In Table 17, the nitrogen content in the parts of fumigated and control plants is shown. This table indicates a significant effect was brought about only in a few cases: positive effect in the stem of sunflower plants (daytime and nighttime fumigation) and kidney bean plants (nighttime fumigation). Our previous study (14) using sunflower plants revealed that  $\text{NO}_2$  fumigation at 0.1 and 0.5 ppm for 24 days increased nitrogen content in the leaf, the stem and the root. Spierings (12) and Troiano and Leone (15) reported an increase of nitrogen content in the leaf of tomato plant, but Taylor and Eaton (13) did not find any significant increase. If  $\text{NO}_2$  is absorbed in the plants, the nitrogen is suspected to increase



NO<sub>2</sub> absorption by plants and soils (V)

Table 17 Effect of day and night NO<sub>2</sub> fumigation on the change in nitrogen content of plant parts<sup>a</sup>

Plant	Part	Nitrogen content (% dry weight basis)		
		Control	Day fumigation	Night fumigation
Sunflower	Leaf	5.33	6.15 (115)* <sup>b</sup>	6.03 (113)
	Stem	1.83	2.12 (116)	1.57 ( 86)
	Root	2.39	2.21 ( 92)	2.26 ( 95)
Corn	Leaf blade	3.30	3.12 ( 95)	3.66 (111)
	Leaf sheath	2.71	2.47 ( 91)	2.80 (103)
	Roof	1.81	1.87 (103)	1.70 ( 94)
Kidney bean	Leaf	4.90	5.46 (111)	5.08 (104)
	Stem	2.77	2.67 ( 96)	2.29 ( 83) *
	Root	2.38	2.47 (104)	2.33 ( 98)
Cucumber	Leaf	3.55	3.52 ( 99)	3.59 (101)
	Stem	4.42	3.34 ( 76) ** <sup>b</sup>	3.80 ( 86) *
	Root	3.22	2.94 ( 91)	3.00 ( 93) *
Tomato	Leaf	6.01	6.04 (100)	5.81 ( 97)
	Stem	4.01	4.06 (101)	3.61 ( 90)
	Root	3.46	3.46 (100)	3.35 ( 97)
Swiss chard	Shoot	6.05	6.02 (100)	5.85 ( 97)
	Root	4.02	4.02 (100)	3.80 ( 95)

a, The numerals in the parentheses are relative values to control.

b, Significantly differed from control at 5% (\*) and 1% (\*\*) levels, respectively.

the nitrogen content (dry weight basis). The results in our present report (Table 17) and in other workers' reports do not altogether support this idea. The amount of NO<sub>2</sub>-nitrogen may not be so much as to change the nitrogen content suddenly, and the growth or developing of the plants during the treatment periods may hide the trend of increase of nitrogen content. Increase of total nitrogen in each plant part or in whole plant might be a more useful criterion for the change caused by NO<sub>2</sub> absorption. Table 4 indicates that some plants or some parts show positive effect while others (corn) show a significantly negative effect. The tomato plant in Troiano and Leone's experiment, the sunflower plant in our previous paper (14), and several plants investigated by Fujiwara and Ishikawa (5) showed nitrogen increase by long term fumigation with NO<sub>2</sub> at low (less than 0.5 ppm) concentration. However, it is not sure whether the increase of this nitrogen is caused by NO<sub>2</sub> nitrogen or by an increase in uptake of nitrogen from the soil (or nutrient solution).

Differential effects of fumigation under different light regimes have not been fully studied. Treatment with 30 ppm NO<sub>2</sub> for 1 hr in the nighttime caused more severe injury than treatment during the day (2). Exposure of plants to 4 ppm NO<sub>2</sub> caused severe injury in the daytime, when the nitrite reductase activity in the leaves was low (19). In both experiments, high concentrations of NO<sub>2</sub> were employed, and the present study provided the first information concerning the daytime and nighttime fumigation effect at low NO<sub>2</sub> concentration. Both negative and positive effects of daytime and nighttime fumigation were expected. NO<sub>2</sub> absorption rate is high in the daytime compared with nighttime (19), and actual activity of nitrite reductase, which is believed to be a main enzyme detoxicating NO<sub>2</sub> in plant cells (19), is high under light condition. NO<sub>2</sub> nitrogen was

found to be transformed into amino acids, a source of proteins (18). In the daytime,  $\text{NO}_2$  nitrogen may be easily transformed into beneficial forms in plants, if the amount of  $\text{NO}_2$  absorbed in the cells is within the plant capacity of  $\text{NO}_2$  detoxication, and if the participation of  $\text{NO}_2$  nitrogen does not disrupt the plant metabolism. In the nighttime, the actual nitrite reductase activity is believed to be low, but still operative (7), and  $\text{NO}_2$  absorption rate is small (19). Therefore, if plants can utilize  $\text{NO}_2$  before suffering from injury, additional uptake of the  $\text{NO}_2$ -nitrogen may be beneficial, but if the nitrite reductase is not effectively operative, plants could be damaged. Our present study revealed that 0.3 ppm  $\text{NO}_2$  fumigation in the daytime is not harmful for the growth of plants, but nighttime fumigation showed both results (positive effect to sunflower, kidney bean, and cucumber plants, negative effect to corn plant.)

Whether the  $\text{NO}_2$  fumigation depresses plant uptake of soil and fertilizer nitrogen was checked as following. The increased dry-weight ( $\Delta$ dry weight) and the increased fertilizer- and soil-nitrogen ( $\Delta$ fertilizer- and soil-nitrogen) during the treatment time was compared in the fumigated and non-fumigated plants, and the ratios (%), the values in the fumigated plants to the values in the non-fumigated plants were compared (Fig. 2). The correlation was  $Y=0.75X+18.2$  ( $r=0.95$ ): where  $Y=\Delta$ fertilizer- and soil-nitrogen ratio and  $X=\Delta$ dry weight ratio. This relationship indicates that when the dry-weight increase is depressed by 10%, the fertilizer- and soil-nitrogen increase is depressed by 14%, and when the former is accelerated by 20%, the latter is accelerated only by 8%.  $\text{NO}_2$  fumigation at

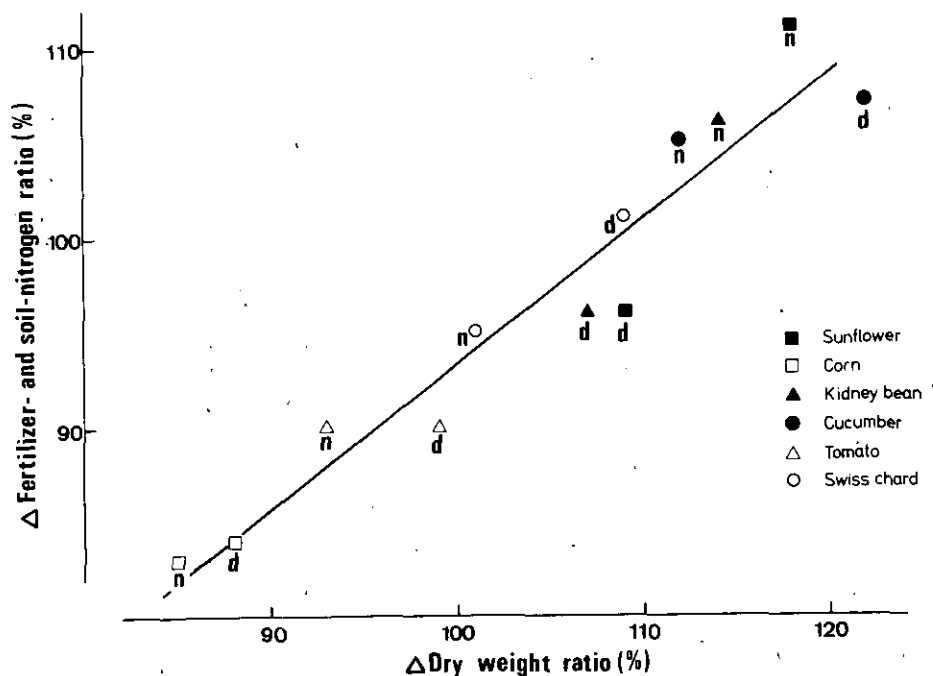

Fig. 2. The relationship between dry-weight ratio and fertilizer- and soil-nitrogen ratio in the  $\text{NO}_2$ -fumigated plants

d: daytime fumigated plants, n: nighttime fumigated plants. For detailed explanation, see the text.

0.3 ppm depressed the uptake of fertilizer- and soil-nitrogen in 6 plants. This also indicates that NO<sub>2</sub> fumigation does not necessarily cause the increase of the apparent nitrogen content of the plants (Table 17).

*Estimation method for the amount of NO<sub>2</sub>-nitrogen absorbed in plants*

Very few trials in the estimation of plant absorption of air pollutants at low concentrations in long-term experiments have been reported. In the elegant experiments by Olsen (10) and Bromfield (1), an isotope dilution method was employed to estimate the amount of sulfur absorbed by cotton and mustard plant from ambient atmosphere. The crops used in these experiments were grown in nutrient solution, where sulfur was applied as sulfate, and labeled with <sup>35</sup>S. In our previous experiment (9), plants were cultured in the nutrient solution containing <sup>15</sup>N-labeled KNO<sub>3</sub> as the nitrogen source, and the NO<sub>2</sub>-nitrogen absorbed by the plant was estimated after 2 weeks' fumigation with 0.3 ppm NO<sub>2</sub>. In this experiment, non-fumigated plants were also grown with <sup>15</sup>N-labeled nitrogen, and correction for seed-nitrogen participation was conducted using the data in non-fumigated plants.

The present experiment may be the first trial in the estimation of NO<sub>2</sub>-nitrogen absorbed in the soil-grown plants. If the plants are soil-grown, and, in addition, if they are fumigated with the atmosphere containing nitrogen compounds utilizable for plants, three nitrogen sources (soil, seed, nitrogen in the atmosphere) are expected to be absorbed into the plants, and fertilizer nitrogen, if applied, may be another source. In the present experiment, NO<sub>2</sub> fumigation was started about 2 weeks after germination of seeds. During this time all seed nitrogen was considered to have been distributed to the plant parts. Therefore, during the fumigation period, three nitrogens (soil, fertilizer, NO<sub>2</sub>) were expected to be main nitrogen sources for plants. Among three, fertilizer was applied as (NH<sub>4</sub>)<sub>2</sub>SO<sub>4</sub> and labeled with <sup>15</sup>N; which made possible to calculate the amount of the fertilizer nitrogen absorbed in plants. The distribution of the fertilizer nitrogen in plants was not much affected by NO<sub>2</sub> fumigation (Table 19). Soil-nitrogen is considered as the nitrogen which is concomitantly moving with fertilizer nitrogen by the same rates both in NO<sub>2</sub>-fumigated and non-fumigated plants. Using equation 4, the amount of soil-nitrogen absorbed by the NO<sub>2</sub>-fumigated plants was calculated. The estimation of the absorbed NO<sub>2</sub>-nitrogen in different plant parts was carried out, and shown in Table 11-16. The values obtained from the difference in ΔTN and ΔSN of control and fumigated plants were sometimes negative, and the third method, ΔSN-ΔSN', gave mostly positive values.

A recent proposal by Fried and Broeshart (3) and Fried and Middelboe (4), "a measurement of the amount of nitrogen fixed by a legume crop", stimulated us to calculate the amount of NO<sub>2</sub>-nitrogen absorbed by plants using an equation similar to theirs.

$$\text{NO}_2\text{-nitrogen in plant part} = \left( 1 - \frac{\text{atom \% excess } ^{15}\text{N in NO}_2\text{-fumigated plant}}{\text{atom \% excess } ^{15}\text{N in non-fumigated plant}} \right) \times \text{total nitrogen in NO}_2\text{-fumigated plant} \quad (5)$$

The values calculated using this equation are shown in Table 18. These values are very similar to those in Tables 11-16. Therefore, the equation 5 may be useful and convenient for estimating the amount of NO<sub>2</sub>-nitrogen absorbed by plants.

*Distribution of fertilizer-, soil- and NO<sub>2</sub>-nitrogen in plants*

Percentage distribution of nitrogen from 3 sources in plants is summarized in Table

Table 18 Estimation of the amount of  $\text{NO}_2$ -nitrogen absorbed in plants applying Fried and Middleboe's equation

$\text{NO}_2$ treatment	Plant part	$\text{NO}_2$ -Nitrogen absorbed (mg) <sup>a</sup>						Swiss chard
		Sunflower	Corn	Kidney bean	Cucumber	Tomato		
Daytime	Leaf	53.4	B <sup>b</sup> 18.5	44.8	51.1	30.6	} 26.5	
	Stem	7.9	S <sup>b</sup> 4.1	7.7	9.0	8.2		
	Root	5.9	4.5	0.5	7.5	2.0	4.2	
	Total	67.2	27.1	53.0	67.6	40.8	30.7	
Nighttime	Leaf	27.8	B 10.6	21.2	13.0	14.5	} 10.1	
	Stem	4.1	S 2.5	6.5	- 0.4	0.3		
	Root	2.1	4.0	1.7	1.7	0.4	2.7	
	Total	34.0	17.1	29.4	14.3	15.2	12.8	

a. For calculation, see the text.

b. B and S means leaf blade and leaf sheath, respectively.

Table 19 Percentage distribution of the nitrogen of different sources in plant parts

Treatment	Plant part	Sunflower			Corn			Kidney bean		
		$\Delta\text{FN}$	$\Delta\text{SN}$ ( $\Delta\text{SN}'$ ) <sup>b</sup>	$\text{NO}_2$ -N <sup>c</sup>	$\Delta\text{FN}$	$\Delta\text{SN}$ ( $\Delta\text{SN}'$ )	$\text{NO}_2$ -N	$\Delta\text{FN}$	$\Delta\text{SN}$ ( $\Delta\text{SN}'$ )	$\text{NO}_2$ -N
Control	Leaf	65	50	-	B <sup>d</sup> 56	47	-	63	45	-
	Stem	23	23	-	S <sup>d</sup> 27	16	-	26	26	-
	Root	11	27	-	16	37	-	11	28	-
Daytime fumigation	Leaf	67	53	79	B 57	46	72	68	50	90
	Stem	24	23	13	S 24	14	10	21	22	11
	Root	9	23	8	18	40	18	11	28	-1
Nighttime fumigation	Leaf	70	55	80	B 59	49	74	64	45	70
	Stem	21	21	16	S 25	14	6	23	23	16
	Root	10	14	5	16	37	21	13	32	14
Control		Cucumber			Tomato			Swiss chard		
	Leaf	61	50	-	63	67	-	88	90	-
	Stem	24	27	-	27	25	-			
Daytime fumigation	Leaf	63	52	77	63	66	76	87	89	86
	Stem	24	27	13	29	27	19			
	Root	12	20	11	8	7	5	13	11	14
Nighttime fumigation	Leaf	61	50	89	63	67	97	88	90	77
	Stem	26	29	5	27	24	0			
	Root	13	21	6	10	9	3	12	10	23

a. Calculated from  $\Delta\text{FN}$  of Table 5 ~ 10.

b. Calculated from  $\Delta\text{SN}$  (in control plants) and  $\Delta\text{SN}'$  (in fumigated plants) of Table 5 ~ 10.

c. Calculated from ( $\Delta\text{SN}-\Delta\text{SN}'$ ) of Table 11~16.

d. B and S mean leaf blade and leaf sheath, respectively.

19. Generally, the percentages of the fertilizer-nitrogen in the leaf were higher than those of soil-nitrogen, whereas in the root the percentages of soil-nitrogen overcome those of fertilizer-nitrogen. The percentages of NO<sub>2</sub>-nitrogen in the leaf in fumigated plants were more than those of fertilizer-nitrogen in all plants except swiss chard plant. The trends of fertilizer- and soil-nitrogen distributions were similar to the previous experiment using rice plants grown in the waterlogged soil (20). The percentages of NO<sub>2</sub>-nitrogen in the roots were lower than that of fertilizer-nitrogen in all plants except swiss chard plant. These data indicate that absorption of NO<sub>2</sub> is mainly through the leaves.

A reversal in NO<sub>2</sub>-nitrogen distribution was found in the swiss chard plant. The dry weight and the leaf area of this plant were small compared with other plants (Tables 1 and 2). The small leaf area of swiss chard during most period of the NO<sub>2</sub> treatment may have caused the relatively large contribution of the NO<sub>2</sub> absorption route through the soil and root.

#### *NO<sub>2</sub> absorbing activity of plants*

In the present experiment the concentration of NO<sub>2</sub> was maintained at a constant 0.3 volppm during the treatment time. In the daytime, when the sunlight was strong, some NO was produced, and total NO<sub>x</sub> (NO<sub>2</sub> + NO) concentration was increased by the apparent addition of NO to 0.3 ppm NO<sub>2</sub>. The rate of NO absorption is less than one-tenth that of NO<sub>2</sub> in higher plants (6, 17), and in the soil (17). Therefore, the maximum NO-nitrogen absorbed by plants and soils may be less than 1% of absorbed NO<sub>2</sub>-nitrogen.

The NO<sub>2</sub>-nitrogen absorbing activity shown in Table 20 was calculated using the following equations: the first equation 6-1 was previously used (9).

a) Plant dry weight basis ( $\mu\text{g N/gdw/h}$ )

$$\text{Activity} = \frac{\text{Absorbed NO}_2\text{-nitrogen}}{\frac{\text{Initial dry weight} + \text{Final dry weight}}{2}} \div 140 \quad (6-1)$$

b) Leaf area basis ( $\mu\text{g N}/100\text{cm}^2/\text{h}$ )

$$\text{Activity} = \frac{\text{Absorbed NO}_2\text{-nitrogen}}{\frac{\text{Initial leaf area} + \text{Final leaf area}}{2}} \div \frac{100}{140} \quad (6-2)$$

Here linear increase in dry-weight and in leaf-area during the treatment period was assumed.

In this table, two calculations were carried out, (i) with the assumption that each plant part absorbed NO<sub>2</sub> separately, and (ii) with the assumption that all NO<sub>2</sub>-nitrogen was absorbed through the leaf having a relatively large surface area. In the former, translocation of NO<sub>2</sub>-nitrogen to other plant parts after it is absorbed by a plant part was not taken into consideration. In the latter it was assumed that no absorption from the stem or from the root occurs, this is not always true because the stem or the root can also absorb some NO<sub>2</sub>-nitrogen (16). The case of swiss chard plant in the present experiment could be an example.

Calculation (i) in Table 20 indicates the leaf is the most active site of NO<sub>2</sub> absorption (dry weight basis) during both daytime and nighttime. Among 6 species, the sunflower leaf showed the greatest activity followed by the tomato leaf; the corn leaf showed the lowest activity during both daytime and nighttime. The absorbing activity during daytime

was around twice as much as that of nighttime. The data obtained in the previous experiment (9), where plants were cultured in a nutrient solution and fumigated with 0.3 ppm  $\text{NO}_2$  throughout day and night continuously, are redrawn in Table 21 with further calculation to adjust the dimension of the activity to Table 20. The values in the previous experiment are generally between daytime activity and nighttime activity of the present experiment. When the leaf activity is expressed as leaf-area basis, sunflower leaf had highest activity, followed by swiss chard and tomato leaves.

The another calculation (ii) in Table 20 revealed a 10–30% greater activity than the first calculation. Reliability of the second calculation has some doubt. In the stem and root, uptake after soil-sorption of  $\text{NO}_2$  may not so small to ignore it under the long-term fumigation as suggested in the case of swiss chard plant in the present experiment. However, the information of the quantity of the absorbed  $\text{NO}_2$ -nitrogen through the root in long-term experiments are lacking. Further research is needed to draw the details of the fate of  $\text{NO}_2$  in a soil-plant system.

Additional nitrogen uptake in plants occurs during  $\text{NO}_2$  fumigation. The highest percentage increase in the present experiments was found in sunflower plant:12.4% by

Table 20  $\text{NO}_2$ -nitrogen absorbing activity<sup>a</sup> of 6 plant species at 0.3 ppm  $\text{NO}_2$

Treatment time	Plant part	$\text{NO}_2$ -nitrogen absorbing activity					
		Sunflower	Corn	Kidney bean	Cucumber	Tomato	Swiss chard
(i) With assumption that each plant part absorbed $\text{NO}_2$ separately		$\mu\text{gN/gdw/h}$					
Daytime	Leaf	103	Bb22	60	52	86	64
	Stem	18	S <sup>b</sup> 6	12	26	36	
	Root	26	8	—	34	26	48
	Whole	57	14	30	44	63	61
Nighttime	Leaf	57	B 13	36	16	37	25
	Stem	11	S 2	11	3	0	
	Root	9	5	14	5	4	32
	Whole	29	7	23	11	21	25
The leaf absorption is expressed as leaf-area basis		$\mu\text{gN}/100\text{cm}^2/\text{h}$					
Daytime	Leaf	27	5	12	18	23	25
Nighttime	Leaf	14	3	7	6	9	9
(ii) With assumption that all $\text{NO}_2$ -nitrogen in the plant was absorbed through the leaf		$\mu\text{gN/gdw/h}$					
		Leaf dry weight basis					
Daytime		130	30c	66	69	113	75 <sup>d</sup>
Nighttime		71	17c	52	18	38	32 <sup>d</sup>
		Leaf area basis					
Daytime		35	7c	14	26	30	29 <sup>d</sup>
Nighttime		17	4c	9	6	10	12 <sup>d</sup>

a. See the text for explanation.

b. B and S mean leaf blade and leaf sheath, respectively.

c. Leaf blade is considered as "Leaf" in calculation.

d. Shoot is considered as "Leaf" in calculation.

NO<sub>2</sub> absorption by plants and soils (V)

Table 21 NO<sub>2</sub>-nitrogen absorbing activity (water culture experiment<sup>a</sup>)

Plot	Plant part	NO <sub>2</sub> -N absorbing activity (µgN/gdw/h)		
		Sunflower	Corn	Tomato
High-N	Leaf	58	—	48
	Stem	9	—	9
	Root	14	—	11
	Whole	38	—	35
Medium-N	Leaf	50	} 17	41
	Stem	12		13
	Root	4	7	18
	Whole	33	14	32
Low-N	Leaf	56	} 9	46
	Stem	9		12
	Root	15	0.6	37
	Whole	32	6	36

a. Recalculated from the data in Ref (9) for comparison with Table 20.

In this experiment, plants were fumigated with 0.3 ppm NO<sub>2</sub> for 14 days continuously.

daytime fumigation and 7.0% by nighttime fumigation. The lowest percentages were in corn plant: 4.6% by the daytime fumigation and 2.4% by the nighttime fumigation. Provided that daytime and nighttime absorption occurs during 12 hours respectively, total percentages of NO<sub>2</sub>-nitrogen in total nitrogen taken up during the fumigated period could be 23% in sunflower plant and 8% in corn plant. (The similar estimation in the previous experiment (9) reveals 22% in the medium-N plot of sunflower plant, and 14% in the medium-N plot of corn plant). It is generally observed that the amount of absorbed nitrogen in plants is linearly correlated with the NO<sub>2</sub> concentration in the atmosphere (11, 17). If the NO<sub>2</sub> concentration in the atmosphere is reduced to 0.03 ppm, the percentages could be 2.9% and 0.9% in sunflower and corn plants, respectively. The NO<sub>2</sub> concentration in Tokyo is reportedly around 0.03 ppm (average 1974–1975) (8). The contribution of atmospheric NO<sub>2</sub>-nitrogen to the plant nitrogen may be 1–3% in higher plants. However our previous experiment (9) also indicates that the percentage in the sunflower plant, whose growth was depressed by nitrogen deficiency, was 46% with 0.3 ppm NO<sub>2</sub>. Therefore, at 0.03 ppm the percentage in the sunflower grown in the nitrogen-poor soil could be near to 8%.

Special thanks should be given to Mr. A. Shimizu of the division of engineering of our institute. Without his skillful assistance in NO<sub>2</sub> control, this research could not be successful.

References

1. Bromfield, A.R.: Absorption of atmospheric sulfur by mustard (*Sinapis alba*) grown in a glasshouse. *J. Agric. Sci. Camb.* 78: 343–344 (1972).
2. Czech, M. and W. Nothdurft: Untersuchungen über Schädigungen landwirtschaftlicher und gärtnerischer Kulturpflanzen durch Chlor-, Nitrose- und Schwefeldioxydgase. *Landwirt. Forsch.* 4: 1–36 (1952).

3. Fried, M. and H. Broeshart: An independent measurement of the amount of nitrogen fixed by a legume crop. *Plant and Soil* 43: 707-711 (1975).
4. Fried, M. and V. Middelboe: Measurement of amount of nitrogen fixed by a legume crop. *ibid.* 47: 713-715 (1977).
5. Fujiwara, T. and H. Ishikawa: Effect of NO<sub>2</sub> fumigation on several plants. *J. Japan Soc. Air Pollut.* 7: 234 (1972) (in Japanese).
6. Hill, A.C.: Vegetation: a sink for atmospheric pollutants. *J. Air Pollut. Cont. Asso.* 21: 341-346 (1971).
7. Ito, O. and K. Kumazawa: Amino acid metabolism in plant leaf III. The effect of light on the exchange of <sup>15</sup>N-labeled nitrogen among several amino acids in sunflower discs. *Soil Sci. Plant Nutr.* 24: 327-338 (1978).
8. Kiyoura, R.: Comparison and evaluation of several nitrogen dioxide, air quality standards. *J. Air Pollut. Cont. Ass.* 27: 572-573 (1977).
9. Matsumaru, T., T. Yoneyama, T. Totsuka and K. Shiratori: Absorption of atmospheric NO<sub>2</sub> by plants and soils (I). Quantitative estimation of absorbed NO<sub>2</sub> in plant by <sup>15</sup>N method. *Soil Sci. Plant Nutr.* 25: 255-265 (1979).
10. Olsen, R.A.: Absorption of sulfur dioxide from the atmosphere by cotton plants. *Soil Sci.* 84: 107-111 (1957).
11. Rogers, H.H., H.E. Jeffries, E.P. Stahel, W.W. Heck, L.A. Ripperton and A.M. Witherspoon: Measuring air pollutant uptake by plants: a direct kinetic technique. *J. Air Pollut. Cont. Ass.* 27: 1192-1197 (1977).
12. Spierings, F.H.F.G.: Influence of fumigation with NO<sub>2</sub> on growth and yield of tomato plants. *Neth. J. Plant Pathol.* 77: 194-200 (1971).
13. Taylor, O.C. and F.M. Eaton: Suppression of plant growth by nitrogen dioxide. *Plant Physiol.* 41: 132-135 (1966).
14. Totsuka, T., T. Yoneyama, T. Natori and M. Takimoto: Response of plants to atmospheric NO<sub>2</sub> fumigation (1). Effects of NO<sub>2</sub> fumigation on dry-weight growth and nitrogen accumulation in sunflower plant. In *Studies on evaluation and amelioration of air pollution by plants*. Progress report in 1976-1977, Report of special research project, National Institute for Environmental Studies No.2: 67-87 (1978) (in Japanese).
15. Troiano, J.J. and I.A. Leone: Changes in growth rate and nitrogen content of tomato plants after exposure to NO<sub>2</sub>. *Phytopathology* 67: 1130-1133 (1977).
16. Yoneyama, T., A. Hashimoto and T. Totsuka: Absorption of atmospheric NO<sub>2</sub> by plants and soils (IV). Two routes of nitrogen uptake by plants from atmospheric NO<sub>2</sub>: Direct incorporation into aerial plant parts and uptake by roots after absorption into the soil. *Soil Sci. Plant Nutr.* (26: 1-7 (1980).
17. Yoneyama, T. and M. Kaji: (unpublished data).
18. Yoneyama, T. and H. Sasakawa: Transformation of atmospheric NO<sub>2</sub> absorbed in apinach leaves. *Plant & Cell Physiol.* 20: 263-266 (1979).
19. Yoneyama, T., H. Sasakawa, S. Ishizuka and T. Totsuka: Absorption of atmospheric NO<sub>2</sub> by plants and soils (II). Nitrite accumulation, nitrite reductase activity and diurnal change of NO<sub>2</sub> absorption in plant. *Soil Sci. Plant Nutr.* 25: 267-275 (1979).
20. Yoneyama, T. and T. Yoshida: Decomposition of rice residue in tropical soils (I). Nitrogen uptake by rice plants from straw incorporated, fertilizer (ammonium sulfate), and soil. *ibid.* 23:33-40 (1977).



## Absorption of atmospheric NO<sub>2</sub> by plants and soils VI. Transformation of NO<sub>2</sub> absorbed in the leaves and transfer of the nitrogen through the plants<sup>a</sup>

Masakazu Kaji<sup>1</sup>, Tadakatsu Yoneyama<sup>2b</sup>, Tsumugu Tosuka<sup>2</sup> and Hideo Iwaki<sup>1</sup>

<sup>1</sup> Graduate School for Environmental Sciences, University of Tsukuba, Sakura-mura,  
Ibaraki 305

<sup>2</sup> Division of Environmental Biology, The National Institute for Environmental Studies,  
Yatabe, Ibaraki 305

The leaves of sunflower and spinach plants were exposed to <sup>15</sup>N-labeled NO<sub>2</sub> at a concentration of 4–6 ppm for 20 min in the daytime or in the nighttime. Total amount of NO<sub>2</sub>-nitrogen absorbed in sunflower leaves was greater in the daytime than in nighttime. The day and night difference in NO<sub>2</sub> absorption by spinach leaves was not clear. In the daytime, 99% of absorbed NO<sub>2</sub>-nitrogen was transformed into reduced, organic nitrogen compounds with remaining 1% as nitrate and nitrite. In the nighttime, 85–89% <sup>15</sup>N was reduced to organic forms and the rest was nitrate and nitrite. A considerable amount of nitrite was accumulated in the spinach leaves fumigated in nighttime. The analysis of <sup>15</sup>N content in amino acids revealed that the amide nitrogen of glutamine had the highest <sup>15</sup>N content, followed by glutamate, aspartate, alanine and  $\gamma$ -amino butyric acid. Night fumigation showed a higher <sup>15</sup>N incorporation in the amide of glutamine with very low <sup>15</sup>N content in other amino acids. From these results we concluded that the quantity of NO<sub>2</sub> absorption is mostly dependent on the stomatal aperture and that NO<sub>2</sub> absorbed in the cells is converted into nitrate and nitrite and further assimilated into amino acids via glutamine synthetase and glutamate synthase system. These reactions are more rapid under light condition.

The <sup>15</sup>N experiment confirmed that NO<sub>2</sub>-nitrogen absorbed in mature leaves was translocated to growing organs (young leaves, roots). The results suggest that NO<sub>2</sub>-nitrogen could be a nitrogen nutrient under conditions where poisonous effects are not generated.

**Key words:** Absorption of NO<sub>2</sub> – Higher plants – Metabolism of NO<sub>2</sub> – <sup>15</sup>N–nitrogen dioxide – Translocation.

Many studies have shown that higher plants are one of important natural sinks of atmospheric NO<sub>2</sub> (4). Our previous study (16) confirmed, by use of <sup>15</sup>N, that NO<sub>2</sub>-nitrogen is assimilated into amino acids under light conditions. In the present report, NO<sub>2</sub> transformation in plant leaves in the day and night periods is examined by exposing

- a. A part of this report was presented to the 16th annual meeting on radioisotopes in the physical sciences and industry (Tokyo, 1979).
- b. All correspondence should be addressed to T.Y.

spinach and sunflower plants to  $^{15}\text{N}$ -labeled  $\text{NO}_2$ . The transfer of the absorbed  $\text{NO}_2$ -nitrogen to other sites in the sunflower plant was also investigated. So far as is known, no information has been published on the translocation of the  $\text{NO}_2$ -nitrogen in plants after it is absorbed.

## Materials and methods

### *Growing of test plants*

Artificial soils containing vermiculite, peatmoss, perlite and fine gravel by 2:2:1:1 (volume) were prepared, and potted in  $10^{-4}$  a pots with fertilizer, 5g Magamp K ( $\text{N}:\text{P}_2\text{O}_5:\text{K}_2\text{O}=6:40:5$ , W.R.Grace Co., Tennessee, U.S.A.) and 15g Magnesium carbonate per pot.

The seeds of sunflower (*Helianthus annuus* L. cv. Russian mammoth) and spinach (*Spinacia oleracea* L. cv. New asia) were sterilized by steeping in 0.1% usplun solution for 1 hour, and washed by tap water for 24 hours. One week after germination in artificial soils supplied with fertilizer, the seedlings were thinned to 1 plant (sunflower) and 5 plants (spinach) per pot. Every week, 100–200 ml of  $10^{-3}$  strength Hyponex solution was supplied to each pot. Sunflower plants were grown in a naturally-lit chamber with a constant temperature at  $25^\circ\text{C}$  and a relative humidity 70%. Spinach plants were also grown in a naturally-lit chamber with 70% R.H. and the temperature was controlled to  $20^\circ\text{C}$  at daytime (14 hours) and  $15^\circ\text{C}$  at night (10 hours). Thirty to forty days after germination, plants were selected for testing.

### *Experiment for $^{15}\text{NO}_2$ assimilation*

$^{15}\text{N}$ -labeled  $\text{NO}_2$  (95.1 atom %  $^{15}\text{N}$ ) was generated as described previously (18).  $^{15}\text{NO}_2$  fumigation of sunflower and spinach plants were carried out in a fumigation chamber ( $50 \times 50 \times 140$  cm). Plants were put inside the chamber after enclosing the pots in plastic bags to protect the soils from contact with  $\text{NO}_2$ , and fumigated with 4–6 ppm  $^{15}\text{NO}_2$  for 20 min in the daytime (14:00–16:00) with 30 klx of light intensity at the top of plants or in the night (20:00–22:00) without light. The temperature inside the chamber was  $25$ – $30^\circ\text{C}$  during fumigation. The  $\text{NO}_2$  concentration in the fumigation chamber was continuously monitored (KIMOTO Nitrogen Oxides Analyzer, Model 258, Osaka, Japan), and the diminishing amount of  $\text{NO}_2$  was replenished at about 5 min intervals. The air in the chamber was circulated by a small fan. The  $\text{NO}_2$  absorption by plants was so rapid that the  $\text{NO}_2$  concentration fluctuated between 4 and 6 volppm. Unfortunately, only one fumigation chamber was available. Therefore, fumigation was conducted plants to plants.

Immediately after the end of the fumigation treatment, some leaves (around 10 g of fresh weight) were obtained and cooled in an ice box. The cold samples were washed by tap water for 10 sec., dried by tissue papers, then weighed, and stored in a freezer at  $-20^\circ\text{C}$  before following fractionation. The samples were ground in porcelain vessels together with liquid nitrogen, and extracted by 80% ethanol solution. The sample solution was passed through the No.6 filter paper (Toyo-Roshi, Tokyo). Two fractions, the soluble fraction passing through the filter paper and the insoluble fraction remaining on the filter paper, were obtained. A portion of the soluble fraction was passed through a cation exchange resin (Amberlite IR-120,  $\text{H}^+$  type), and two fractions, a basic fraction and a combined acidic and neutral fraction were obtained (15). A portion of the combined acidic and neutral fraction was employed for the measuring the nitrite concentration (17), the remaining portion was used for the measurement of combined nitrate and nitrite

concentration and the <sup>15</sup>N content as described previously (15). It was recently found that passing the samples through the cation exchange resin caused some loss of nitrite (Yoneyama and Iwata, unpublished data). Therefore, the nitrite content estimated in the present experiment could be underestimated. The volume of the basic fraction was reduced by vacuum evaporation at below 40°C, rewetted with an addition of 5 ml of 80% ethanol solution, and dried again. The dried sample was dissolved by addition of 100μl of distilled water. A portion of sample was spotted on a Silica-gel thin layer, and the amino acids were developed to determine the <sup>15</sup>N content by emission spectroscopic method (16). Total nitrogen of the soluble and insoluble fraction was determined by kjeldahl method (8), and the <sup>15</sup>N content was determined by emission spectroscopy. All analyses were duplicated using replicate samples.

#### *Experiment for translocation of NO<sub>2</sub>-nitrogen in sunflower plants*

Six sunflower plants, whose pots were enclosed by plastic bags, were put in the NO<sub>2</sub> fumigation chamber sited in a naturally-lit growth room (25°C, 70% R.H.), and fumigated with <sup>15</sup>NO<sub>2</sub> (2–4 volppm) for 2 hours (14:00–16:00) continuously on a fine day of December. Two plants were immediately harvested and separated into various parts as shown in Table 3. The other 4 plants were retained in the naturally-lit growth room with NO<sub>2</sub>-free atmosphere. After 3 days and again the 8th day, pairs of plants were harvested and separated into various parts. The fresh weights of the separated parts were measured and then dried at 90°C for 3 days. The samples were ground and total nitrogen and the <sup>15</sup>N content in the ground samples were measured as above.

The <sup>15</sup>NO<sub>2</sub> gas in the fumigation chamber contained some <sup>15</sup>NO. The content was less than 10% that of <sup>15</sup>NO<sub>2</sub>. The absorption rate of NO (fresh weight basis) by sunflower and spinach leaves was around one-fifteenth as much as NO<sub>2</sub> absorption rate (Kaji, unpublished data). In this report, the participation of NO-nitrogen in the distribution of <sup>15</sup>N is not taken into account.

## Result and discussion

### *<sup>15</sup>N incorporation into various leaf fractions*

Data summarizing <sup>15</sup>N incorporation are reported in Table 1. The amount of NO<sub>2</sub> nitrogen absorbed could be estimated by dividing the excess <sup>15</sup>N by 0.947. Day and Night absorption (fresh weight basis) in 20 min was 60 and 17 μgN/g in sunflower leaves, and 23 and 24 μgN/g in spinach leaves, respectively. The absorption rate at 25°C, estimated from the disappearance of NO<sub>2</sub> in a gas chamber having sunflower plants inside, also indicated greater absorption in the daytime in comparison with night absorption: the experiment on spinach plants revealed that a larger day absorption also occurred but with a smaller difference between day and night absorption. (Kaji and Yoneyama, unpublished data). No difference observed in the present experiment on spinach leaves which might be attributed to big fluctuations in the control of atmospheric NO<sub>2</sub> concentration.

Percentage distribution of <sup>15</sup>N indicated most (99%) NO<sub>2</sub>-nitrogen was transformed into reduced organic nitrogen compounds in the daytime. In contrast, in the nighttime, a considerable percent (11–15) remained in the acidic forms (maybe nitrate and nitrite) (Table 1). Substantial nitrite was detected in the spinach leaves fumigated in the night. The amount of nitrate coming from atmospheric NO<sub>2</sub> was greater in the nighttime fumigation than in daytime fumigation. Usually, no nitrite is detected in the non-fumigated leaves (16), therefore, the nitrite detected in the NO<sub>2</sub>-fumigated leaves was considered to originate from atmospheric NO<sub>2</sub> and to have a <sup>15</sup>N content of 94.7

Table 1  $^{15}\text{N}$  distribution in the leaves exposed to  $^{15}\text{N}$ -labeled  $\text{NO}_2$  at 4-6 ppm for 20 min

Fraction	Nitrogen content ( $\mu\text{g N/g f.w.}$ )		$^{15}\text{N}$ content (atom % excess)		Excess $^{15}\text{N}$ ( $\mu\text{g N/g f.w.}$ )	
	Day	Night	Day	Night	Day	Night
Sunflower						
Insoluble	7193	5634	0.13	0.04	9.4 ( 17) <sup>c</sup>	2.3 ( 14)
Soluble	753	755	6.31	1.88	47.5 ( 83)	14.2 ( 86)
$\text{NO}_3^- + \text{NO}_2^-$	137	138	0.40	1.32	0.5 ( 1)	1.8 ( 11)
$\text{NO}_2^-$	0.02	0.03	94.7 <sup>a</sup>	94.7 <sup>a</sup>	0.02	0.03
$\text{NO}_3^-$	137	138	0.35 <sup>b</sup>	1.28 <sup>b</sup>	0.48	1.77
Other	616	617	7.63 <sup>b</sup>	2.01 <sup>b</sup>	47.0 ( 82)	12.4 ( 75)
Total	7946	6389			56.9 (100)	16.5 (100)
Spinach						
Insoluble	3782	3668	0.09	0.04	3.4 ( 16)	1.5 ( 7)
Soluble	602	610	3.03	3.50	18.2 ( 84)	21.3 ( 93)
$\text{NO}_3^- + \text{NO}_2^-$	136	227	0.16	1.56	0.2 ( 1)	3.5 ( 15)
$\text{NO}_2^-$	0.03	1.5	94.7 <sup>a</sup>	94.7 <sup>a</sup>	0.03	1.4
$\text{NO}_3^-$	136	225	0.13 <sup>b</sup>	0.93 <sup>b</sup>	0.17	2.1
Other	466	383	3.99 <sup>b</sup>	4.64 <sup>b</sup>	18.6 ( 83)	17.8 ( 78)
Total	4384	4278			21.6 (100)	22.8 (100)

a, All  $\text{NO}_2^-$  in the leaves was assumed to originate from atmospheric  $\text{NO}_2$ .

b, Calculated by the following equation:  $\frac{\text{Excess } ^{15}\text{N}}{\text{Nitrogen content}} \times 100$

c, The numerals in the parentheses are relative values to "Total" (100).

atom % excess  $^{15}\text{N}$ . Using this assumption, the  $^{15}\text{N}$  content of nitrate was calculated (Table 1). Compared with the  $^{15}\text{N}$  content in the nitrate a higher  $^{15}\text{N}$  content was estimated in "other" fraction (considered to be mainly consisting of amino acids).

Table 2 shows the  $^{15}\text{N}$  content in the amino acids and amides of the basic fraction. In the day, the highest  $^{15}\text{N}$  content was detected in the amide nitrogen of glutamine, and also high  $^{15}\text{N}$  content was detected in aspartic acid, glutamic acid, serine, alanine and  $\gamma$ -amino butyric acid. In the night, an extremely high  $^{15}\text{N}$  content was detected in the amide nitrogen of glutamine, but the  $^{15}\text{N}$  contents of other amino acids were relatively low. These data have a pattern of  $^{15}\text{N}$  content similar to the cases of  $^{15}\text{N}$ -labeled nitrite, nitrate and ammonia assimilation (6, 7).

Based on nitrate and nitrite assimilation (6) and on data obtained in the present experiment, a scheme for nitrogen dioxide reactions at the cellular level is proposed in Fig. 1. The quantity of  $\text{NO}_2$  absorption is related to  $\text{NO}_2$  concentration (13) and stomatal aperture (17): this resulted in more absorption in the atmosphere of high  $\text{NO}_2$  concentration, and in the daytime. Absorbed  $\text{NO}_2$  is converted into nitrate and nitrite in the cells (16), as in water. The nitrate and nitrite is reduced to ammonia by a combination of nitrate reductase and nitrite reductase. The operation of this reduction system is more active under light conditions (6). In the night, nitrite and nitrate originating from  $\text{NO}_2$  could be accumulated than in the daytime. The ammonia produced

NO<sub>2</sub> absorption by plants and soils (VI)

Table 2 <sup>15</sup>N content in free amino acids and amides in sunflower and spinach leaves fumigated with <sup>15</sup>N-labeled NO<sub>2</sub> at 4-6 ppm for 20 min <sup>a</sup>

Amino acid and amide	Sunflower		Spinach	
	Day	Night	Day	Night
Aspartic acid	10.0 ( 44)	1.51 ( 9)	7.63 ( 68) <sup>b</sup>	3.20 ( 15)
Glutamic acid	11.6 ( 51)	1.40 ( 9)	8.88 ( 99)	3.35 ( 16)
Serine	6.26 ( 28)	0.14 ( 1)	2.69 ( 24)	0.38 ( 2)
Alanine	14.3 ( 63)	1.39 ( 9)	6.91 ( 61)	2.19 ( 10)
γ-amino butyric acid	12.3 ( 54)	1.95 ( 12)	5.54 ( 49)	1.89 ( 9)
Leucine+Isoleucine	—	0.40 ( 3)	1.79 ( 16)	0.19 ( 1)
Phenylalanine	1.30 ( 6)	0.17 ( 1)	1.11 ( 10)	0.07 ( 0)
Proline	1.25 ( 6)	—	0.94 ( 8)	0.29 ( 1)
Histidine	0.50 ( 2)	0.20 ( 1)	—	—
Arginine	0.79 ( 3)	0.09 ( 1)	—	0.27 ( 1)
Glutamine				
Amino-N	8.30 ( 37)	0.60 ( 4)	6.54 ( 58)	1.44 ( 7)
Amide-N	22.6 (100)	16.0 (100)	11.3 (100)	21.4 (100)
Asparagine				
Amino-N	0.91 ( 4)	—	2.73 ( 24)	0.17 ( 1)
Amide-N	2.52 ( 11)	—	3.56 ( 32)	2.85 ( 13)

- a, <sup>15</sup>N-labeled <sup>15</sup>NO<sub>2</sub> (94.7 atom % excess <sup>15</sup>N) was exposed to plants in the daytime or in the nighttime. All data are expressed as atom % excess <sup>15</sup>N.  
 b, The numerals in parentheses are relative values to the <sup>15</sup>N content in the amide-nitrogen of glutamine.

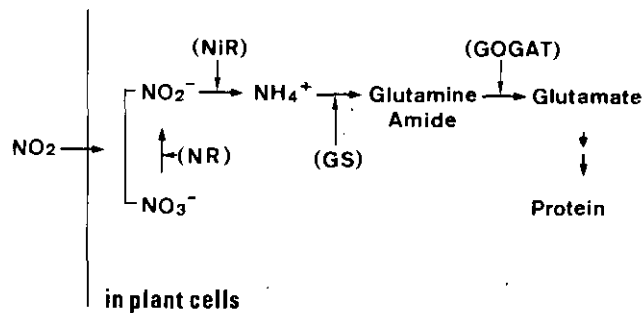

Fig. 1. A scheme of possible reactions of nitrogen dioxide at the cellular level.  
 NR: Nitrate reductase, NiR: nitrite reductase, GS: Glutamine synthetase, GOGAT: Glutamate synthase.

may be assimilated first into the amide of glutamine whose amide nitrogen is transferred to glutamic acid and other amino acids. This assimilation system proceeds by a combination of glutamine synthetase and glutamate synthase (11). Experiment by Ito et al. (7) indicated that the transfer of nitrogen from ammonia to the amide of glutamine is

not dependent on the light, but nitrogen transfer from the amide to amino acid is strictly dependent on the light. The results shown in Table 2 are consistent with their findings. Very rapid transformation of  $\text{NO}_2$  in plant cells with very small amounts remaining as nitrite and nitrate suggest that  $\text{NO}_2$  might be directly coupled with a reductase (nitrite reductase is probable) before it changes into nitrite and nitrate. The probability of this reduction system should be studied. In conclusion,  $\text{NO}_2$  absorbed in the leaf is actively assimilated into reduced organic nitrogen compounds through nitrate assimilation systems.

*Distribution of  $^{15}\text{N}$  absorbed as  $\text{NO}_2$  in sunflower plants*

Data summarizing the distribution of the  $\text{NO}_2$ -nitrogen absorbed in the shoot of sunflower plants are reported in Table 3. During the 8-day experimental period, the fresh weight and total nitrogen of the plants increased, especially in Leaf 4,5,6,7, Stem 1,2,3,4,5,6 and Root.  $^{15}\text{NO}_2$  was absorbed mainly in the leaves (Leaf 2,3,4,5) at day 0; the bigger the leaf fresh weight the more  $\text{NO}_2$ -nitrogen absorbed. Percent distribu-

Table 3 *Distribution of  $^{15}\text{N}$  in sunflower plants<sup>a</sup>*

Parts <sup>b</sup>	Fresh weight (g)	Total nitrogen (mg)	Excess $^{15}\text{N}$ ( $\mu\text{g N}$ )	Distribution of $^{15}\text{N}$ (%)	Changes of % during sampl- period
(1) Day 0 (Just after the end of $^{15}\text{NO}_2$ fumigation)					
Leaf 5	0.87	7.9	190	10.5	
4	2.12	16.4	724	40.1	
3	2.27	13.7	592	32.8	
2	1.01	3.8	148	8.2	
1	0.72	1.4	19	1.1	
Stem 3	2.32	6.4	47	2.6	
2	2.02	4.7	26	1.4	
1	2.08	4.4	3	1.8	
Root	2.34	4.6	28	1.6	
Total (mean)	15.74	63.1	1806	100.1	
Individual	(11.82, 19.66)	(51.7, 74.6)	(1587, 2024)		
(2) Day 3					
					Day 0 - Day 3
Leaf 6	0.69	5.9	243	13.6	+ 29.6
5	1.43	11.2	464	26.3	
4	2.15	14.1	478	27.1	- 13.0
3	2.36	13.7	269	15.3	- 17.5
2	0.79	3.3	41	2.3	- 5.9
1	0.74	1.5	3	0.2	- 0.9
Stem 4	0.96	2.4	38	2.2	+ 2.2
3	2.07	4.6	31	1.8	- 0.8
2	2.41	4.1	29	1.6	+ 0.2
1	3.14	4.5	62	3.5	+ 1.7
Root	3.03	5.8	105	6.0	+ 4.4
Total (mean)	19.74	70.9	1761	100.1	
Individual	(18.96, 20.52)	(70.0, 71.8)	(1935, 1586)		

NO<sub>2</sub> absorption by plants and soils (VI)

Parts <sup>b</sup>	Fresh weight (g)	Total nitrogen (mg)	Excess <sup>15</sup> N (μg N)	Distribution of <sup>15</sup> N (%)	Changes of % during sampling period
(3) Day 8					Day 3 - Day 8
Leaf 7	1.74	13.5	114	5.7	
6	4.05	29.4	276	13.7	+ 5.8
5	5.07	28.5	645	32.1	+ 5.8
4	4.54	22.3	478	23.8	- 3.3
3	3.00	13.9	170	8.4	- 6.9
2	1.15	4.4	31	1.5	- 0.8
1	0.64	1.1	7	0.3	+ 0.1
Stem 6	0.64	1.7	14	0.7	+ 0.7
5	1.65	3.6	19	0.9	+ 0.9
4	3.59	6.7	33	1.6	- 0.6
3	7.50	11.0	41	2.0	+ 0.2
2	7.45	9.3	36	1.8	+ 0.2
1	6.60	7.3	57	2.8	- 0.7
Root	8.02	12.1	91	4.5	- 1.5
Total (mean)	55.61	164.4	2012	99.8	
Individual	(62.67, 48.55)	(182.0, 146.7)	(2110, 1903)		

a, The plants were fumigated with 2-4 ppm <sup>15</sup>NO<sub>2</sub> for 2 hours at Day 0.

All data indicated are means of the analytical results of duplicates (two plants).

b, The numbers of the leaf and stem in three sampling times are corresponding each other.

tion of <sup>15</sup>N to the stems and the root was very small, though the fresh weight was considerable. The amount of total <sup>15</sup>N in the plant had hardly varied and no significant decrease of <sup>15</sup>N was detected in the plants after 8 days. In another experiment, where a specific leaf was labeled with <sup>15</sup>N, no significant loss over 3 days was observed (Kaji, unpublished). The percentage of total <sup>15</sup>N in plant organs, 0,3 and 8 days after fumigation was calculated and the distribution of the nitrogen absorbed as NO<sub>2</sub> from the atmosphere was discussed. The NO<sub>2</sub>-nitrogen absorbed in the mature or almost mature leaves (Leaf 1,2,3,4) decreased during Day 0 and Day 3, whereas the percentage of the nitrogen increased in the rapidly growing parts (Leaf 5,6, Stem 1,4 and Root). During Day 3 to Day 8, the percentage <sup>15</sup>N in the mature leaves (Leaf 2,3,4) was further reduced with increases in the growing leaves and stems (Leaf 5,6,7 and Stem 5,6). In the root, the percentage was declined from Day 3 to Day 8. These data confirm that the nitrogen absorbed as NO<sub>2</sub> can be transferred from the parts where NO<sub>2</sub> was absorbed to other parts. The direction of the transfer is generally from mature organs towards growing organs. The data also suggest that some nitrogen in the shoot could be translocated to the root, and again it might be returned to the shoot. Martin (10) and Pate (12) reported that some <sup>15</sup>N was detected in the root when <sup>15</sup>N-labeled nitrate was fed to the leaves.

<sup>35</sup>S absorbed in the leaves as SO<sub>2</sub> from atmosphere seems to be translocated to other organs (2,3,14) and the translocation form is sulfate (14). Fluoride, another air pollutant, was reported not to be translocated from the leaf to the stem nor from the stem to the root (1).

The  $\text{NO}_2$  absorbed in the leaves are rapidly assimilated into amino acids and amides as reported in the first experiment, and some of the amino acids and amides (5) may be translocated to other organs (mainly to growing parts). We plan to investigate the specific relationship among plant parts concerning nitrogen allocation.

#### References

1. Benedict, H.M., J.M. Ross and R.W. Wade: The disposition of atmospheric fluorides by vegetation. *Int. J. Air Wat. Poll.* 8: 279–289 (1964).
2. Fried, M.: The absorption of sulfur dioxide by plants as shown by the use of radioactive sulfur. *Proc. Soil Sci. Soc. Amer.* 13: 135–138 (1948).
3. Garsed, S.G. and D.J. Read: The uptake and translocation of  $^{35}\text{SO}_2$  in soybean *Glycine max* var. Biloxi. *New Phytol.* 73: 299–307 (1973).
4. Hill, A.C.: Vegetation: A Sink for atmospheric pollutants. *J. Air Pollut. Cont. Asso.* 21: 341–346 (1971).
5. Ito, O. and K. Kumazawa: Nitrogen assimilation in sunflower leaves and upward and downward transport of nitrogen. *Soil. Sci. Plant Nutr.* (Tokyo) 22: 181–189 (1976).
6. Ito, O. and K. Kumazawa: Amino acid metabolism in plant leaf III. The effect of light on the exchange of  $^{15}\text{N}$ -labeled nitrogen among several amino acids in sunflower discs. *ibid.* 24: 327–336 (1978).
7. Ito, O., T. Yoneyama and K. Kumazawa: Amino acid metabolism in plant leaf IV. The effect of light on ammonium assimilation and glutamine metabolism in the cells isolated from spinach leaves. *Plant & Cell Physiol.* 19: 1109–1119 (1978).
8. Jackson, W.A., R.E. Johnson and R.J. Volk: Nitrite uptake by nitrogen-depleted wheat seedlings. *Physiol. Plant.* 32: 37–42 (1974).
9. Jensen, K.F. and T.T. Kozlowski: Absorption and translocation of sulfur dioxide by seedlings of four forest tree species. *J. Environ. Qual.* 4: 379–382 (1975).
10. Matjín, P.: Translocation of nitrogen to the shoot of young bean plants after uptake of  $\text{NO}_3^-$  and  $\text{NH}_4^+$  by the root. *Z. Pflanzenern. Bodenk.* Heft 2: 181–193 (1976) (German with English summary).
11. Mifflin, B.J. and B.P. Lea: The pathway of nitrogen assimilation in plants. *Phytochemistry* 15: 873–885 (1976).
12. Pate, J.S.: Uptake, assimilation and transport of nitrogen by plants. *Soil Biol. Biochem.* 5: 109–119 (1973).
13. Rogers, H.H., H.E. Jeffries, E.P. Stahel, W.W. Heck, L.A. Ripperton and A.M. Witherspoon: Measuring air pollutant uptake by plants: a direct kinetic technique. *J. Air Pollut. Cont. Asso.* 27: 1192–1197 (1977).
14. Thomas, M.D., R.H. Hendricks, L.C. Bryner and G.R. Hill: A study of the sulphur metabolism of wheat, barley and corn using radioactive sulphur. *Plant Physiol.* 19: 227–244 (1944).
15. Yoneyama, T.: Nitrogen nutrition and growth of the rice plant III. Origin of amino-nitrogen in the developing leaf. *Soil Sci. Plant Nutr.* (Tokyo) 24: 199–205 (1978).
16. Yoneyama, T. and H. Sasakawa: Transformation of atmospheric  $\text{NO}_2$  absorbed in spinach leaves. *Plant & Cell Physiol.* 20: 263–266 (1979).
17. Yoneyama, T., H. Sasakawa, S. Ishizuka and T. Totsuka: Absorption of atmospheric  $\text{NO}_2$  by plants and soils (II) Nitrite accumulation, nitrite reductase activity and diurnal change of  $\text{NO}_2$  absorption in leaves. *Soil Sci. Plant Nutr.* 25: 267–275 (1979).
18. Yoneyama, T., H. Sasakawa, T. Totsuka and Y. Yamamoto: Response of plants to atmospheric  $\text{NO}_2$  fumigation (5). Measurements of  $^{15}\text{NO}_2$  uptake, nitrite accumulation and nitrite reductase activity in herbaceous plants. In *Studies on evaluation and amelioration of air pollution by plants*. Progress report in 1976–1977. Report of special research project, NIES R-2, p103–111, 1978.



## Absorption of atmospheric NO<sub>2</sub> by plants and soils VII.

### NO<sub>2</sub> absorption by plants: re-evaluation of the air-soil-root route

Tadakatsu Yoneyama<sup>1</sup>, Takashi Yasuda<sup>2</sup>, Jinya Yazaki<sup>2</sup> and Tsumugu Totsuka<sup>1</sup>

<sup>1</sup> Division of Environmental Biology, The National Institute for Environmental Studies,  
Yatabe, Ibaraki 305

<sup>2</sup> Department of Agricultural Chemistry, Nihon University, Setagaya, Tokyo 154

Plants in soil were fumigated with <sup>15</sup>N-labeled NO<sub>2</sub> for 60–70 min, and the NO<sub>2</sub>-nitrogen which had accumulated in the plants was estimated. Just after fumigation, NO<sub>2</sub>-nitrogen was mostly distributed in the leaves with a small amount in the stems and roots. However, if the fumigated plants were further grown in NO<sub>2</sub>-free air for 1 week, a considerable increase of NO<sub>2</sub>-nitrogen was observed especially in the stems and roots. When the soils of the pots, wherein plants were grown, were fumigated with NO<sub>2</sub>, the NO<sub>2</sub>-nitrogen sorbed into soils was absorbed by plants over a long time period; in the experiment using corn plants, absorption continued for 14 days. The amount of NO<sub>2</sub>-nitrogen absorbed by roots appeared to be partly dependent on the mass of the roots (dry-weight).

The conclusions are as follows: NO<sub>2</sub> in the air is absorbed by the aerial plant parts (mainly leaves) and soil. NO<sub>2</sub>-nitrogen sorbed into the soil is gradually absorbed by the roots, the process taking a relatively long time. Therefore, the proportion of NO<sub>2</sub>-nitrogen absorbed by roots could be considerable when plants were fumigated with NO<sub>2</sub> for long periods.

**Key words:** Absorption of NO<sub>2</sub>—Air pollution—Nitrogen dioxide—Plant and soil system

Plants and soils are considered to be major sinks of atmospheric air pollutants, such as SO<sub>2</sub> and NO<sub>2</sub> (1, 3). However, the mechanisms of the removal systems are not fully understood. Studies on NO<sub>2</sub> absorption and metabolism in soil and plant systems may serve for the understanding of the fate of atmospheric NO<sub>2</sub>, an important air pollutant. In such studies, <sup>15</sup>N-labeled NO<sub>2</sub> may be of use to trace the NO<sub>2</sub>-nitrogen. Investigations of <sup>15</sup>NO<sub>2</sub> metabolism in plant leaves revealed that NO<sub>2</sub> is rapidly changed into organic forms through the general nitrate assimilation pathways (7). The routes for NO<sub>2</sub>-nitrogen absorption by plants had been determined from tracer experiments using <sup>15</sup>N (5). One route is a direct absorption by the aerial plant parts, and another is root uptake of the NO<sub>2</sub>-nitrogen after NO<sub>2</sub> is sorbed into soil. The contribution of the latter route in NO<sub>2</sub>-nitrogen absorption by plants in a short time was estimated to be relatively small.

Successive long-term examinations (10) have revealed that the amount of NO<sub>2</sub>-nitrogen in plants fumigated in the nighttime was around one-half of the daytime absorption; the ratio obtained for day and night absorption was rather high in comparison with the rate obtained from a short-term <sup>15</sup>NO<sub>2</sub> fumigation experiment (8). It was

considered that the amount of  $\text{NO}_2$ -nitrogen absorbed through soil and root could not be insignificant in a long-term  $\text{NO}_2$  fumigation. This was inferred from the following observations: a considerable amount of  $\text{NO}_2$ -nitrogen was detected in the soil in a short-term  $^{15}\text{NO}_2$  fumigation (5), and the  $\text{NO}_2$ -nitrogen was easily transferred from the site of absorption to the lower soil layers along with water movement: A long time, however, might be required for absorption of the  $\text{NO}_2$ -nitrogen in soils through the plant roots.

In this paper, we have conducted some long-term experiments to evaluate the air-soil-root route on  $\text{NO}_2$  absorption.

#### Materials and methods

The soil used in the present experiment was the same type as used in a previous experiment (5). The soil water content was 30% on a dry weight basis. One kg of fresh soil was placed in each pot (soil surface area:  $100\text{ cm}^2$ , pot height: 20 cm).

In the first experiment, young plants of six species were used. The seeds of cucumber (*Cucumis sativus* L.), kidney bean (*Phaseolus vulgaris* L.), tomato (*Lycopersicon esculentum* Mill), sunflower (*Helianthus annuus* L.), swiss chard (*Beta vulgaris* L.), and corn (*Zea mays* L.) were sown in pots on the 9th of May, and grown in a naturally-lit growth room (room temperature:  $25^\circ\text{C}$ , relative humidity: 70%). On the 30th of May, 6 uniform plants were selected for each plant species. The seedlings of sunflower, swiss chard, and corn were transferred into an artificially-lit growth chamber (air temperature:  $25^\circ\text{C}$ , relative humidity: 70%), and fumigated with  $^{15}\text{NO}_2$  at 1 ppm for 1 hour in the daytime (12:00–16:00) in the light (30 klx) using a small fumigation chamber as reported previously (5); fumigation for each species was conducted separately. On the next day, the seedlings of cucumber, kidney bean and tomato were also fumigated with  $^{15}\text{NO}_2$  in the same manner. Three plants were sampled just after termination of  $^{15}\text{NO}_2$  fumigation and, another three were sampled after 1 week during which the fumigated plants were further grown under  $\text{NO}_2$ -free conditions in the naturally-lit growth room. Plants were separated into several parts as indicated in Table 1.

Sunflower and corn plants of two different growth ages were prepared and used for the  $^{15}\text{NO}_2$  fumigation experiment as follows: the sunflower seeds were sown in 80 pots on the 31st of May, and grown in a naturally-lit growth room. Twelve uniform plants were obtained and six were fumigated with  $^{15}\text{NO}_2$  at 2.0–2.2 ppm (hour-average of minute-determination) in the nighttime (23:00–24:00, June 14) in the dark and the another six were fumigated under light condition (30 klx) in the same manner in the daytime (12:25–13:25, June 15) using the gas fumigation chamber as mentioned in the first experiment. The rest of the sunflower plants were supplied with fertilizer (0.25 g of  $(\text{NH}_4)_2\text{SO}_4$  and 0.25 g of  $\text{KH}_2\text{PO}_4$  per each pot) on the 15th of June, and further grown in the naturally-lit growth room. Day and nighttime fumigation to large plants were performed on the 27th of June under the same conditions as for the small plants. Corn plants were sown on the 30th of July (large plants) and on the 13th of August (small plants); the former plants were supplied with 0.25 g of  $(\text{NH}_4)_2\text{SO}_4$  and 0.25 g of  $\text{KH}_2\text{PO}_4$  on the 13th of August.  $^{15}\text{NO}_2$  fumigation to the large and small plants was carried out on the 28th of August under the same conditions as for the sunflower plants. Plants were sampled just after the termination of  $^{15}\text{NO}_2$  fumigation and after 1 week during that time the fumigated plants were further grown in the naturally-lit growth room, and separated into several parts as indicated in Table 2 (sunflower) and in Table 3

NO<sub>2</sub> absorption by plants and soils (VII)

(corn).

Time-course experiments on plant uptake of NO<sub>2</sub>-nitrogen sorbed into soils were carried out for sunflower and corn plants as follows. The seeds of sunflower and corn were sown on the 23rd and 27th of August, respectively, and grown in a naturally-lit growth room. 0.5 g of (NH<sub>4</sub>)<sub>2</sub>SO<sub>4</sub> and 0.5 g of KH<sub>2</sub>PO<sub>4</sub> were added to each pot on the 31st of August. On the 13th of September, 16 uniform corn plants were transferred to an artificially-lit growth chamber. The soils of eight pots were fumigated with <sup>15</sup>NO<sub>2</sub> for 70 min at 3.8 ppm (average of minute-determination) in the daytime, and to another 8 pots, a solution of K<sup>15</sup>NO<sub>3</sub> (1.5 mg K<sup>15</sup>NO<sub>3</sub> per each pot) was applied on the soils. The <sup>15</sup>NO<sub>2</sub> fumigation box (30 × 60 × 68 cm) had 8 holes on the upper side; through which

Table 1 *Distribution of the nitrogen derived from NO<sub>2</sub> in young plants fumigated with NO<sub>2</sub><sup>a</sup> for 1 hour at 1 ppm<sup>b</sup> in the daytime*

Plant	Plant part	Just after the termination of fumigation				1 week after NO <sub>2</sub> treatment			
		Leaf area (cm <sup>2</sup> )	Dry weight (mg)	Total N (mg)	N from NO <sub>2</sub> (μg)	Leaf area (cm <sup>2</sup> )	Dry weight (mg)	Total N (mg)	N from NO <sub>2</sub> (μg)
Cucumber	Leaf	135	680	7.6	55	187	1064	9.5	49
	Stem		90	1.1	1		118	1.8	6
	Root		139	3.3	3		262	3.8	10
	Total				59±1				65±1
Kidney bean	Leaf	266	563	13.4	123	415	967	38.1	106
	Stem		321	3.3	3		671	12.0	18
	Root		470	10.4	4		778	17.6	22
	Total				130±8				146±19
Tomato	Leaf	69.1	174	6.6	51	122	465	8.9	43
	Stem		62.0	1.5	3		215	2.3	9
	Root		38.1	1.0	1		109	1.8	6
	Total				54±12				58±12
Sunflower	Leaf	116	262	9.5	115	140	432	11.2	102
	Stem		213	1.7	4		715	2.6	17
	Root		155	2.2	1		462	4.4	19
	Total				120±6				138±8
Swiss chard	Shoot	34.7	90.0	4.0	24	79.2	339	8.3	25
	Root		11.8	0.4	0.4		163	8.2	7
	Total				24±5				32±4
Corn	Leaf blade	216	443	6.4	38	312	850	7.6	33
	Leaf sheath		267	2.9	2		501	3.2	13
	Root		524	6.0	3		978	9.0	21
	Total				43±11				67±13

a, NO<sub>2</sub> gas was labeled with <sup>15</sup>N (99.7 atom %), and the amount of NO<sub>2</sub>-nitrogen in plants was estimated.

b, NO<sub>2</sub> concentration was monitored every minute, and the hour-averages fluctuated between 1.00–1.07 ppm for the fumigation of the 6 plant species.

the plants shot leaf sheaths and leaf blades, and the leaf sheaths in the box were covered by vinyl tubes to protect plants from direct contact with  $^{15}\text{NO}_2$  gas (5). The air in the box was continuously mixed using 3 small fans (Model PXJ43BI, JAPAN SERVO CO. LTD). (It had previously been checked that the  $\text{NO}_2$  introduced into the box quickly mixed with air, and the  $\text{NO}_2$  concentration in the box rapidly became almost constant at all points.) After  $^{15}\text{N}$  application of  $^{15}\text{NO}_2$  or  $\text{K}^{15}\text{NO}_3$ , 2 plants were sampled at the following times, just after  $^{15}\text{N}$  application (Day 0), 3 days (Day 3), 7 days (Day 7) and 14 days (Day 14). The plants were separated into several parts as shown in Table 5. Fumigation by  $^{15}\text{NO}_2$  and application of  $\text{K}^{15}\text{NO}_3$  to sunflower plants were conducted on the 20th of September in a similar way as for corn plants. Plants were also sampled on appropriate days after  $^{15}\text{N}$  treatment, and separated into the parts shown in Table 4.

Small plants were watered every two days and large plants were watered every day to provide moist conditions. The concentration of  $\text{NO}_2$  in the fumigation boxes was monitored minute by minute by a Kimoto  $\text{NO}_x$  analyzer, and the decrease of  $\text{NO}_2$  in the box was replenished with addition. The  $\text{NO}_2$  concentration in the box usually fluctuated within 20% of the appointed concentration, and variations of the average  $\text{NO}_2$  concentration at the fumigation periods were within 10% for each treatment. Some  $\text{NO}$  was evolved in the  $\text{NO}_2$  fumigation chambers, but the estimated amount of  $\text{NO}$ -nitrogen absorbed by plants and soils was less than 2% of the absorbed  $\text{NO}_2$ -nitrogen.

Table 2 *Distribution of nitrogen derived from  $\text{NO}_2$  in the sunflower plants fumigated with  $\text{NO}_2^a$  for 1 hour at 2.0–2.2 ppm<sup>b</sup> in the daytime and nighttime*

Plant mass	Fumigation time	Plant part	Just after the termination of fumigation				1 week after $\text{NO}_2$ treatment			
			Leaf area (cm <sup>2</sup> )	Dry weight (mg)	Total N (mg)	N from $\text{NO}_2$ ( $\mu\text{g}$ )	Leaf area (cm <sup>2</sup> )	Dry weight (mg)	Total N (mg)	N from $\text{NO}_2$ ( $\mu\text{g}$ )
Small	Daytime	Leaf	115	298	12.4	224	151	522	11.2	169
		Stem		143	2.4	6		665	3.1	40
		Root		93	1.8	1		399	4.1	48
		Total				231±2				257±7
Small	Nighttime	Leaf	107	213	10.9	51	154	472	9.9	72
		Stem		106	2.2	2		526	2.6	14
		Root		58	1.2	0.5		419	4.3	21
		Total				54±2				107±9
Large	Daytime	Leaf	381	1220	41.4	437	488	1770	43.7	540
		Stem		1370	10.2	43		3450	15.4	161
		Root		980	14.1	13		1260	14.4	100
		Total				493±6				801±12
Large	Nighttime	Leaf	370	1193	40.8	133	548	2050	47.1	153
		Stem		1470	10.3	9		2937	12.2	28
		Root		920	14.5	7		1497	16.6	39
		Total				149±10				220±26

a,  $\text{NO}_2$  gas was labeled with  $^{15}\text{N}$  (99.7 atom %), and the amount of  $\text{NO}_2$ -nitrogen was estimated.

b, Hour-averages for each fumigation fluctuated between 2.0–2.2 ppm.

NO<sub>2</sub> absorption by plants and soils (VII)

All samples were dried in an oven at 90°C for at least 3 days, and before analysis they were further dried at 105°C for 1 hour. Ground samples were employed for analysis of total nitrogen by the Kjeldahl method. The <sup>15</sup>N content was determined by an emission spectroscopic method (4). The amount of nitrogen in the plants originating from NO<sub>2</sub> or KNO<sub>3</sub> was calculated as follows.

$$\text{Total nitrogen in plants} \times \frac{{}^{15}\text{N atom \% excess of plant samples}}{{}^{15}\text{N atom \% excess of } {}^{15}\text{N compound applied}}$$

The mean values for three plants are indicated in Tables 1, 2 and 3, while the mean values for two plants are shown in Tables 4 and 5. The data for total NO<sub>2</sub>-nitrogen are followed by the standard deviation from the mean.

Results

In young plants a large proportion of NO<sub>2</sub>-nitrogen was distributed in the leaves by a 1-hour NO<sub>2</sub> fumigation in 6 plant species as shown in Table 1, and the plants harvested 1 week after NO<sub>2</sub> treatment had accumulated more NO<sub>2</sub>-nitrogen; especially, the amount

Table 3 *Distribution of nitrogen derived from NO<sub>2</sub> in the corn plants fumigated with NO<sub>2</sub> a for 1 hour at 2.0–2.2 ppm<sup>b</sup> in the daytime and nighttime*

Plant mass	Fumigation time	Plant part	Just after the termination of fumigation				1 week after NO <sub>2</sub> treatment			
			Leaf area (cm <sup>2</sup> )	Dry weight (mg)	Total N (mg)	N from NO <sub>2</sub> (μg)	Leaf area (cm <sup>2</sup> )	Dry weight (mg)	Total N (mg)	N from NO <sub>2</sub> (μg)
Small	Nighttime	Leaf blade	193	210	7.4	68	275	561	10.6	88
		Leaf sheath		121	3.8	5		303	4.1	30
		Root		167	3.4	3		569	6.3	38
		Total				76±13				156±9
Small	Nighttime	Leaf blade	—	235	8.6	3	299	653	12.1	48
		Leaf sheath		130	4.2	0.4		319	4.3	19
		Root		166	3.2	2		498	5.8	17
		Total				5±1				84±6
Large	Daytime	Leaf blade	807	1772	59.5	820	1205	3753	65.2	574
		Leaf sheath		1012	23.1	22		3040	29.5	229
		Root		890	17.4	5		2250	27.9	164
		Total				847±109				967±108
Large	Nighttime	Leaf blade	—	1549	52.7	12	1117	3315	61.7	16
		Leaf sheath		881	21.6	2		2274	33.0	27
		Root		858	17.5	3		1894	25.1	20
		Total				17±6				63±10

a, b, See the footnote of Table 2.

of NO<sub>2</sub>-nitrogen in stems and roots had increased. For most of the plants investigated, the NO<sub>2</sub>-nitrogen which had accumulated in the leaves by NO<sub>2</sub> fumigation decreased during the following week, perhaps being translocated to other plant parts. The percentage increase of NO<sub>2</sub>-nitrogen during 1 week relative to the initial NO<sub>2</sub>-nitrogen were 7, 8, 10, 15, 33 and 56% in tomato, kidney bean, cucumber, sunflower, swiss chard and corn plants, respectively.

Daytime fumigation resulted in an increased accumulation of NO<sub>2</sub>-nitrogen in all parts for both small and large sunflower plants compared to nighttime fumigation as shown in Table 2. After 1 week, more NO<sub>2</sub>-nitrogen was detected in the plants. The percentage increase was 11% (small plants) and 80% (large plants) for the daytime-fumigated plants, and 98% (small plants) and 48% (large plants) for nighttime-fumigated plants. A similar investigation for corn plants (Table 3) indicated that the amount of NO<sub>2</sub>-nitrogen absorbed in the leaves in the nighttime was only 4% (small plants) and 1% (large plants) of the NO<sub>2</sub>-nitrogen in the leaves fumigated in the daytime. After 1 week, more NO<sub>2</sub>-nitrogen was detected in the plants than initially; especially for the leaf sheaths and roots, a large increase of NO<sub>2</sub>-nitrogen was observed. The percentage increase of the NO<sub>2</sub>-nitrogen for 1 week was 105% (small plants) and 14% (large plants) for daytime-fumigated plants, and 1600% (small plants) and 270% (large plants) for nighttime-fumigated plants.

When only the soils, on which the plants were grown, were exposed to NO<sub>2</sub>, a

Table 4 Nitrogen absorption by sunflower plants when NO<sub>2</sub> or KNO<sub>3</sub> was applied to soils<sup>a</sup>

Days after <sup>15</sup> N treatment	Plant part	NO <sub>2</sub> treatment					KNO <sub>3</sub> treatment				
		Leaf area (cm <sup>2</sup> )	Dry weight (mg)	Total N (mg)	N from NO <sub>2</sub> (μg)	Distribution (%)	Leaf area (cm <sup>2</sup> )	Dry weight (mg)	Total N (mg)	N from KNO <sub>3</sub> (μg)	Distribution (%)
Day 0	Leaf	440	1414	68.5	0		525	1779	85.2	0	
	Stem		1024	16.3	1			1254	12.9	0	
	Root		738	15.7	0			751	13.2	3	
	Total				1					3	
Day 3	Leaf	624	2035	96.1	150	61	536	1759	85.5	100	63
	Stem		1802	15.1	32	13		1641	20.6	25	16
	Root		922	15.2	63	26		875	15.9	34	21
	Total				245±29	100				159±15	100
Day 7	Leaf	747	2026	92.2	140	56	718	1785	82.0	95	58
	Stem		2405	20.1	60	24		2797	15.0	29	18
	Root		1085	14.5	49	20		1105	15.1	40	24
	Total				249±12	100				164±17	100
Day 14	Leaf	914	2266	73.0	122	52	776	2127	80.9	135	61
	Stem		3302	15.7	33	14		2768	16.4	27	12
	Root		1003	8.6	20	8		1299	13.8	19	9
	Bud		915	25.2	61	26		766	19.0	40	18
	Total				236±5	100				221±17	100

a, The nitrogen applied as NO<sub>2</sub> or KNO<sub>3</sub> was labeled with <sup>15</sup>N (99.7 atom %), and the amount of the nitrogen derived from NO<sub>2</sub> or KNO<sub>3</sub> was estimated. <sup>15</sup>NO<sub>2</sub> gas was fumigated for 70 min at 3.8 ppm (average of minute-determinations). 1.5 mg of K<sup>15</sup>NO<sub>3</sub> was applied to each pot.

NO<sub>2</sub> absorption by plants and soils (VII)

Table 5 Nitrogen absorption by corn plants when NO<sub>2</sub> or KNO<sub>3</sub> was applied to soils<sup>a</sup>

Days after <sup>15</sup> N treatment	Plant part	NO <sub>2</sub> treatment					KNO <sub>3</sub> treatment				
		Leaf area (cm <sup>2</sup> )	Dry weight (mg)	Total N (mg)	N from NO <sub>2</sub> (μg)	Distribution (%)	Leaf area (cm <sup>2</sup> )	Dry weight (mg)	Total N (mg)	N from KNO <sub>3</sub> (μg)	Distribution (%)
Day 0	Leaf blade	306	776	33.1	0		298	797	33.5	0	
	Leaf sheath		384	17.2	1			440	17.6	3	
	Root		328	9.8	1			345	10.3	0	
	Total				2					3	
Day 3	Leaf blade	446	921	43.9	56	41	518	1036	42.2	35	47
	Leaf sheath		544	23.5	63	46		459	17.9	28	37
	Root		305	8.8	18	13		649	15.2	12	16
	Total				137±5	100				75±41	100
Day 7	Leaf blade	1023	2321	81.7	132	46	837	2202	77.9	63	44
	Leaf sheath		1297	26.7	90	31		1192	27.7	54	38
	Root		1050	21.2	65	23		1193	23.6	27	19
	Total				287±36	100				144±9	101
Day 14	Leaf blade	1298	3253	78.5	177	54	1472	3240	88.6	104	55
	Leaf sheath		2052	41.1	99	30		1881	38.2	62	32
	Root		1819	25.8	54	16		1570	21.5	24	12
	Total				330±15	100				193±29	99

a, See the footnote of Table 4.

cumulative increase of NO<sub>2</sub>-nitrogen was observed in sunflower plants (Table 4) and corn plants (Table 5). In sunflower plants, the increase of NO<sub>2</sub>-nitrogen in plants appeared to stop after 3 days, but in corn plants, it continued up to Day 14. A simultaneous examination of the nitrogen absorption from KNO<sub>3</sub> applied to the soils indicated that plants continued to absorb KNO<sub>3</sub> nitrogen upto Day 14, though a large amount of nitrogen was absorbed within 1 week. The distributions of nitrogen derived from NO<sub>2</sub> or KNO<sub>3</sub> in plants were similar.

### Discussion

The aim of the present examination was to evaluate quantitatively the significance of the NO<sub>2</sub>-nitrogen absorption in plants through the air-soil-root route in comparison with the direct absorption through the aerial plant parts. Our previous paper (5) indicated that the contribution of the air-soil-root route for NO<sub>2</sub>-nitrogen absorption over a short time was insignificant. Most of the NO<sub>2</sub>-nitrogen in the plants sampled just after termination of the <sup>15</sup>NO<sub>2</sub> fumigation periods (60–70 min) originated from the NO<sub>2</sub>-nitrogen absorbed directly by the aerial plant parts. The increase of NO<sub>2</sub>-nitrogen in the plants kept in NO<sub>2</sub>-free air for 1 week could be attributed to the absorption by the plant roots of

NO<sub>2</sub>-nitrogen sorbed into the soil. The experiments presented here indicate that it took rather a long time for plants to absorb the NO<sub>2</sub>-nitrogen sorbed into soils. Within 1 week after NO<sub>2</sub> fumigation in plant-soil systems, a considerable amount of NO<sub>2</sub>-nitrogen sorbed into soils was absorbed in young plants (Table 1), in small and large sunflower plants (Table 3) and in small and large corn plants (Table 4). Especially, the amount of NO<sub>2</sub>-nitrogen absorbed by nighttime-fumigated plants through the roots after the fumigation period had ended were large (Tables 2 and 3). After 1 week the total NO<sub>2</sub>-nitrogen in small sunflower and corn plants, fumigated in the nighttime, reached to 42% and 54% of that of the plants fumigated in the daytime, respectively.

Previous examinations (2, 9) indicate that NO<sub>2</sub> sorbed into soils converts to nitrate and nitrite, and the nitrite is rapidly oxidized to nitrate. Experiments by Yoneyama et al. (9) indicate that nitrate and nitrite produced from NO<sub>2</sub> move down to deeper soil-layers following the movement of water. The nitrate and nitrite, which approach the roots, can be absorbed by plants, and some is reduced into organic nitrogen

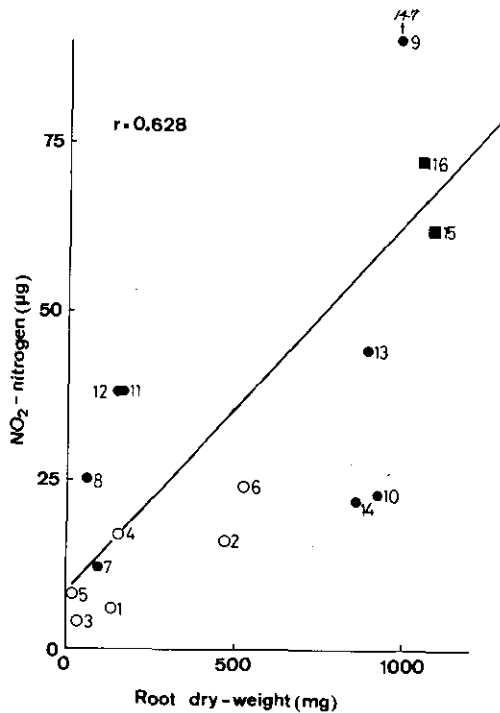

Fig. 1. Relationship between root dry-weight and NO<sub>2</sub>-nitrogen absorbed through the air-soil-root route. The amount of NO<sub>2</sub>-nitrogen was recalculated assuming that soils were fumigated with 1 ppm NO<sub>2</sub> and kept in NO<sub>2</sub>-free air for 1 hour, thereafter, in all cases. Data were obtained from 1. cucumber, 2. kidney bean, 3. tomato, 4. sunflower, 5. swiss chard and 6. corn of Table 1, 7. small sunflower (daytime), 8. small sunflower (nighttime), 9. large sunflower (daytime), and 10. large sunflower (nighttime), of Table 2, 11. small corn (daytime), 12. small corn (nighttime), 13. large corn (daytime), and 14. large corn (nighttime), of Table 3, 15. sunflower of Table 4 and 16. corn of Table 5.



compounds in the plants (6). The nitrogen absorbed from roots may be distributed to a greater extent in the roots and the stems than the nitrogen taken up by the leaves. We did not determine the distribution of NO<sub>2</sub>-nitrogen in soils, therefore the amount of NO<sub>2</sub>-nitrogen which remained in the soils after plant uptake is unknown.

The factors which determine the amount of NO<sub>2</sub>-nitrogen taken up by plant roots are interesting. The mass of plant roots is considered to be one of the main factors. The relationship between the dry weight of the roots at the fumigation time and the amount of NO<sub>2</sub>-nitrogen taken up through soils is shown in Fig. 1, where it is assumed that 1 ppm NO<sub>2</sub> was fumigated for 1 hour and the plants were grown further in NO<sub>2</sub>-free air for 1 week. A significant relationship was found. However, other factors of soil conditions and root nature should also be taken into account.

#### References

1. Abeles, F.G., L.E. Cracker, L.E. Forrence and G.R. Leather: Fate of air pollutants: removal of ethylene, sulfur dioxide, and nitrogen dioxide by soil. *Science* 173:914-916 (1971).
2. Ghiorse, W.C. and M. Alexander: Effect of microorganisms on the sorption and fate of sulfur dioxide and nitrogen dioxide in soil. *J. Environ. Qual.* 5:227-230 (1976).
3. Hill, A.C.: Vegetation: A sink for atmospheric pollutants. *J. Air Pollut. Control Assoc.* 21:341-346 (1971).
4. Yoneyama, T., Y. Arima and K. Kumazawa: Sample preparation from dilute ammonia for emission spectrographic analysis of heavy nitrogen. *J. Sci. Soil Manure Japan* 46:146-7 (1975).
5. Yoneyama, T., A. Hashimoto and T. Totsuka: Absorption of atmospheric NO<sub>2</sub> by plants and soils (IV). Two routes of nitrogen uptake by plants from atmospheric NO<sub>2</sub>: Direct incorporation into aerial plant parts and uptake by roots after absorption into the soil. *Soil Sci. Plant Nutr.* 26:1-7 (1980).
6. Yoneyama, T., E. Iwata and J. Yazaki: Nitrite utilization in the roots of higher plants. *ibid.* 26:9-23 (1980).
7. Yoneyama, T. and H. Sasakawa: Transformation of atmospheric NO<sub>2</sub> absorbed in spinach leaves. *Plant & Cell Physiol.* 20:263-266 (1979).
8. Yoneyama, T., H. Sasakawa, S. Ishizuka and T. Totsuka: Absorption of atmospheric NO<sub>2</sub> by plants and soils (II) Nitrite accumulation, nitrite reductase activity and diurnal change of NO<sub>2</sub> absorption in leaves. *Soil Sci. Plant Nutr.* 25:267-275 (1979).
9. Yoneyama, T., T. Totsuka, A. Hashimoto and J. Yazaki: Absorption of atmospheric NO<sub>2</sub> by plants and soils (III). Change in the concentration of inorganic nitrogen in the soil fumigated with NO<sub>2</sub>: The effect of water conditions. *ibid.* 25:337-348 (1979).
10. Yoneyama, T., T. Totsuka, N. Hayakawa and J. Yazaki: Absorption of atmospheric NO<sub>2</sub> by plants and soils (V). Day and night NO<sub>2</sub>-fumigation effect on the plant growth and estimation of the amount of NO<sub>2</sub>-nitrogen absorbed by plants. *Res. Rep. from the Nat. Inst. for Environ. Studies* No. 11, p31-51, (1980).

## Specific inhibition of photosystem II activity in chloroplasts by fumigation of spinach leaves with SO<sub>2</sub>

Ken-ichiro Shimazaki and Kiyoshi Sugahara

Division of Environmental Biology, The National Institute for Environmental Studies,  
Yatabe, Ibaraki 305

The phytotoxic effects of sulfur dioxide (SO<sub>2</sub>) were investigated by fumigating spinach plants with SO<sub>2</sub>. Inhibition of 2,6-dichloroindophenol (DCIP) photoreduction was observed in spinach chloroplasts isolated from fumigated leaves. NADP and DCIP photoreductions were inhibited to a similar extent by fumigation with 2.0 ppm SO<sub>2</sub> but electron flow from reduced DCIP to NADP was not affected. When electron flow from H<sub>2</sub>O to NADP was inhibited by 36%, a 39% inhibition of non-cyclic photophosphorylation was observed. However, phenazine methosulfate (PMS)-catalyzed cyclic photophosphorylation was as active as in the control chloroplasts. Moreover, in the presence of PMS, no significant suppression was observed in the extent of light-induced H<sup>+</sup> uptake or in the rate of H<sup>+</sup> efflux in chloroplasts. From these results, it can be concluded that SO<sub>2</sub> inhibits the electron flow driven by photosystem II when plants have been fumigated with SO<sub>2</sub>.

In spinach leaves fumigated with SO<sub>2</sub>, the rate of photosynthetic O<sub>2</sub> evolution was reduced under light-limited conditions, while the rate of respiratory O<sub>2</sub> uptake was slightly changed. Key words: chloroplasts – effect of SO<sub>2</sub>-electron transport – photosystem II – photosynthesis – sulfur dioxide

Sulfur dioxide, a major atmospheric pollutant, has been known to cause damages to plant. Environmental factors affecting SO<sub>2</sub> phytotoxicity, description of visible injuries, and the susceptibility of many plant species have been reported by a number of workers (5, 6, 10, 12, 23, 24, 25). However, there are few reports on damage to plants by gaseous SO<sub>2</sub> with respect to physiological alterations at the subcellular level (9, 21).

Chlorosis and necrosis are the most prominent phenomena of SO<sub>2</sub> phytotoxicity and are derived from the breakdown of photosynthetic pigments localized in the thylakoid membranes. Recently, Wellburn et al. (26), using an electron microscope, found swelling of thylakoid membranes induced by SO<sub>2</sub> fumigation. Ziegler (29) showed a great incorporation of sulfur into chloroplast lamellae during SO<sub>2</sub> fumigation. Thus, irreversible damage can be expected in the thylakoid membranes, when plants are exposed to SO<sub>2</sub>. Recently, Malhotra (14) investigated the effect of SO<sub>2</sub> on ultrastructural

---

1. This study was published in; *Plant & Cell Physiol.* 20: 945–955 (1979).

Abbreviations: DCIP, 2,6-dichloroindophenol; DCMU, 3-(3', 4'-dichlorophenyl)-1, 1-dimethylurea; PMS, phenazine methosulfate.

organization and the activity of the DCIP-Hill reaction in chloroplasts by treatment of pine needles in acid aqueous conditions. He showed that  $\text{SO}_2$  induced the swelling of thylakoids and inhibition of the Hill reaction but did not mention the site of inhibition in the electron transport system.

The present study was aimed to determine the steps in the photosynthetic process, especially in the photosynthetic electron transport system, of spinach leaves damaged during  $\text{SO}_2$  fumigation. The results indicated that specific inhibition in photosystem II activity in chloroplasts was caused with  $\text{SO}_2$  fumigation. In addition, we describe the effect of  $\text{SO}_2$  on photosynthetic  $\text{O}_2$  evolution by leaf strips under light-limited conditions.

### Materials and methods

#### *Plant materials*

Spinach (*Spinacia oleracea* L. cv. New Asia) plants were grown in pots containing vermiculite, peat moss, perlite and fine gravels (2:2:1:1, v/v) at 20°C in the daytime and 15°C at night with a relative humidity of 70% in a glass house under sunlight. Seeds were treated with 0.1% hydromercurichlorophenol for 1 hr and washed with distilled water for 24 hr before sowing. A mold containing 4 g/liter Magamp K and 8 g/liter magnesia lime was applied first and 1 g/liter Hyponex was supplied every 5 days as nutrients. Plants used for the experiments were 4–6 weeks old.

#### *SO<sub>2</sub> fumigation*

Spinach plants were fumigated with 1.0 or 2.0 ppm (v/v)  $\text{SO}_2$  in a growth cabinet (230 × 190 × 170 cm) at 20°C with a relative humidity of 75% under illumination. Plants preconditioned for 1 to 2 hr in light were transferred quickly into the growth cabinet in which an appropriate concentration of  $\text{SO}_2$  had been adjusted for fumigation.  $\text{SO}_2$  was prepared by diluting 6,000 ppm  $\text{SO}_2$  in nitrogen with air. Analysis of  $\text{SO}_2$  in air was made at two positions in the growth cabinet with a pulsed fluorescent analyzer (Thermo Electron Corp.). Wind velocity in the cabinet was 0.22 m/sec. Illumination was provided with heat-filtered white light using stannous halide vapor lamps (Toshiba Yoko Lamp, 400 W) at a light intensity of 25,000–35,000 lux at the leaf level.

#### *Preparation of chloroplasts*

After  $\text{SO}_2$  fumigation, spinach leaves were homogenized in 0.05 M Tricine-NaOH buffer (pH 7.5) containing 0.02 M NaCl and 0.4 M sucrose at 0°C. After filtering the homogenate through four layers of gauze, the filtrate was centrifuged at 200 × g for 5 min and the chloroplasts were isolated from the supernatant by centrifugation at 1,500 × g for 7 min. Chlorophyll concentrations were determined using absorption coefficients of Mackinney (13).

#### *Measurement of photosynthetic electron transport*

The rates of DCIP and NADP photoreduction were determined by following the absorbance changes at 590 and 340 nm, respectively, using a Hitachi 556 dual wavelength spectrophotometer. The measurements were performed at 22°C. Actinic light was obtained from a tungsten lamp (ELMO, S-300) after passage through a red cut-off filter (Corning 2403, >620 nm) and a 7 cm layer of water. The light intensity was  $1.5 \times 10^5$  ergs · cm<sup>-2</sup> · sec<sup>-1</sup> measured with a radiometer (Lambda Instrument, Model LI-185). For measuring DCIP photoreduction, a guard filter (Corning 9782) was placed in front of the

photomultiplier to eliminate stray light. Ferredoxin was obtained from the spinach leaves by the method of Tagawa and Arnon (19).

*Measurement of photophosphorylation*

Photophosphorylation was initiated by illumination with heat-filtered white light (intensity 30,000 lux) at 22°C and terminated by the addition of 0.3 ml of 20% trichloroacetic acid to 3 ml of the reaction mixture. The reaction mixture for non-cyclic photophosphorylation coupled with the electron flow from H<sub>2</sub>O to NADP contained 53 mM Tricine-NaOH (pH 7.8), 19 mM NaCl, 3.3 mM MgCl<sub>2</sub>, 1.7 mM ADP, 1.7 mM K<sub>2</sub>HPO<sub>4</sub>, 10<sup>6</sup> cpm <sup>32</sup>Pi, 0.33 mM NADP and a saturated amount of spinach ferredoxin in 3 ml. For the measurement of cyclic photophosphorylation, 0.03 mM PMS was added instead of NADP and ferredoxin but the other ingredients were the same. The amount of ATP formed by chloroplasts was determined according to the method of Avron (3).

*Measurement of light-induced pH change*

Isolated chloroplasts were washed once with the solution containing 0.4 M sucrose and 0.03 M NaCl and resuspended in the same solution. The light-induced pH change was measured with a glass electrode connected to a Hitachi Horiba pH meter (Model F-7ss) at 20°C. The amount of H<sup>+</sup> transported was determined by titration with 50 n equivalents of H<sup>+</sup>. Illumination with a light intensity of 1.5 × 10<sup>5</sup> ergs·cm<sup>-2</sup>·sec<sup>-1</sup> came from a tungsten lamp after passing through a red cut-off filter.

*Measurement of O<sub>2</sub> exchange in leaves*

After fumigation, plants were allowed to stand in the greenhouse overnight to distinguish the irreversible process of SO<sub>2</sub> inhibition (22) from reversible inhibitory actions. Photosynthetic activity was determined with a Clark-type electrode as O<sub>2</sub> evolution in aqueous media (11, 27). Preliminary illumination was done for 60–90 min to obtain a constant photosynthetic activity. Then an excised leaf strip (1.2 × 5 cm) was put between two plastic frames and immersed in the transparent reaction cell. The cell was placed into a thermostatic water bath at 20°C and darkened to estimate the rate of respiratory O<sub>2</sub> uptake. Photosynthesis was started by illumination perpendicular to the leaf surface by a tungsten lamp through a 7-cm layer of water. Light intensity was varied with neutral density filters and measured with a lux-meter (Lichtmeßtechnik, Model PO-57, Berlin). The sensitivity of the oxygen electrode was calibrated using distilled water with known quantities of O<sub>2</sub>.

## Results

*Effects of SO<sub>2</sub> fumigation on electron transport activities in chloroplasts*

Fig. 1 shows the effect of SO<sub>2</sub> on DCIP photoreduction in chloroplasts isolated from fumigated spinach leaves. No significant effect was observed for 1 hr then the inhibition proceeded rapidly during the next 7 hr of fumigation. The rate of DCIP photoreduction was reduced to 40% of the control by fumigation at 2.0 ppm for 5 hr, while 1.0 ppm SO<sub>2</sub> fumigation for 6 hr decreased the rate to 80% of the control. This inhibition may be due to certain toxic substances formed by SO<sub>2</sub> in leaves and released in the medium during the chloroplast isolation procedure or to irreversible damage of reaction components during SO<sub>2</sub> fumigation. Chloroplasts isolated from non-fumigated leaves were incubated in the supernatant obtained from SO<sub>2</sub>-fumigated leaves. After 10 min at 0°C in this supernatant, no inhibitory action on DCIP photoreduction was observed (Table 1). Further, the inactivation of the Hill reaction caused by SO<sub>2</sub> fumiga-

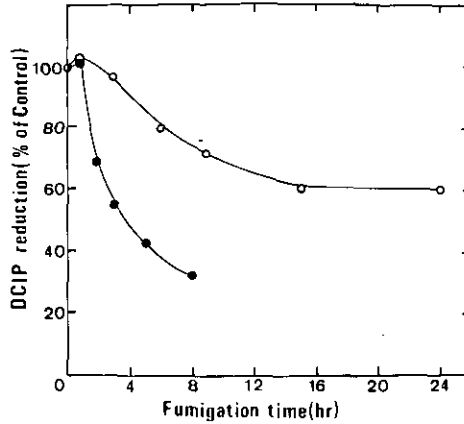

Fig. 1. Inhibition of DCIP photoreduction in chloroplasts by  $\text{SO}_2$  fumigation. Fumigation was performed at 1.0 (○) and 2.0 (●) ppm. The reaction mixture, 4ml, contained 25 mM Tricine-NaOH (pH 7.5), 200 mM sucrose, 10 mM NaCl, 50  $\mu\text{M}$  DCIP and 20  $\mu\text{g}$  chlorophyll as chloroplasts. Rates of DCIP reduction in the reference samples at each sampling time ranged from 125 to 150  $\mu\text{moles mg chl}^{-1} \cdot \text{hr}^{-1}$ .

Table 1 Effects of supernatants obtained from  $\text{SO}_2$  fumigated leaves on DCIP photoreduction in chloroplasts isolated from non-fumigated leaves

Incubation sup	DCIP photoreduction <sup>a</sup>
	$\mu\text{moles/mg chl} \cdot \text{hr}$
Non-fumigated <sup>b</sup>	129
Fumigated <sup>c</sup>	128

Incubation was performed for 10 min at 0°C then the chloroplasts were collected by centrifugation and resuspended in the isolation medium.

<sup>a</sup>DCIP photoreduction was measured under the same conditions as in Fig. 1.

<sup>b</sup>Residual supernatant after isolation of chloroplasts from non-fumigated leaves as described in "Materials and methods".

<sup>c</sup>Residual supernatant after isolation of chloroplasts from fumigated leaves. Fumigation was performed at 2.0 ppm  $\text{SO}_2$  for 5 hr. The activity of electron flow in chloroplasts isolated from fumigated leaves was reduced to 40% of the control.

tion was not removed by washing in 15 mM of Tris-HCl buffer, pH 7.4 (data not shown). These results indicate that  $\text{SO}_2$  fumigation did not produce a substance inhibitory to the DCIP-photoreduction but caused irreversible damage to the reaction during the fumigation.

The inhibitory actions of  $\text{SO}_2$  on the activities of photosystems I and II in chloroplasts are shown in Table 2. Electron flow from  $\text{H}_2\text{O}$  to DCIP was inhibited, while that from reduced DCIP to NADP was not affected under the uncoupled conditions.  $\text{SO}_2$  inhibited the whole-chain electron flow from  $\text{H}_2\text{O}$  to NADP to the same degree as the electron flow from  $\text{H}_2\text{O}$  to DCIP. From these results, we concluded that  $\text{SO}_2$  inhibited the electron flow driven by photosystem II but not that by photosystem I.

Inhibition of photosystem II with SO<sub>2</sub> fumigation

Table 2 *Effects of SO<sub>2</sub> on electron transport activities*

Reaction measured	SO <sub>2</sub> fumigation (hr)		
	0	2	4
	μmoles acceptor reduced/mg chl·hr		
H <sub>2</sub> O → NADP <sup>a</sup>	170	107	66
DCIPH <sub>2</sub> → NADP <sup>a</sup> (+DCMU)	95	97	108
H <sub>2</sub> O → DCIP <sup>b</sup>	217	124	70

SO<sub>2</sub> fumigation was performed at 2.0 ppm. The basic reaction mixture contained 25 mM Tricine-NaOH (pH 7.5), 200 mM sucrose, 10 mM NaCl, 2 mM NH<sub>4</sub>Cl and 20–40 μg chlorophyll as chloroplasts in 4 ml.

<sup>a</sup>For the measurement of electron flow from H<sub>2</sub>O to NADP, 0.2 mM NADP and saturated amounts of ferredoxin were added, while for the measurement of electron flow from DCIPH<sub>2</sub> to NADP, 2 mM sodium ascorbate, 150 μM DCIP and 10 μM DCMU were also present.

<sup>b</sup>For the measurement of DCIP photoreduction, 50 μM DCIP was added to the basic reaction mixture.

Table 3 *Effects of SO<sub>2</sub> on non-cyclic and cyclic photophosphorylations*

Reaction measured	SO <sub>2</sub> concentration (ppm)		Inhibition (%)
	0	2.0	
A). Electron transport	μmoles/mg chl·hr		
H <sub>2</sub> O → NADP <sup>a</sup>	47	30	36
B). Photophosphorylation <sup>b</sup>	μmoles ATP formed/mg chl·hr		
H <sub>2</sub> O → NADP	119	73	39
+PMS	177	177	0

SO<sub>2</sub> fumigation was performed for 3 hr.

<sup>a</sup>NADP photoreduction was determined as described in Table 2 except for the removal of NH<sub>4</sub>Cl from the reaction mixture.

<sup>b</sup>For the measurements of non-cyclic and cyclic photophosphorylations, see Materials and methods.

*Effects of SO<sub>2</sub> fumigation on photophosphorylation and light-induced pH change in chloroplasts*

Table 3 shows the effects of SO<sub>2</sub> applied by fumigation on photophosphorylation in chloroplasts. When electron flow from H<sub>2</sub>O to NADP was inhibited by 36%, non-cyclic photophosphorylation was inhibited by 39%. However, PMS-catalyzed cyclic photophosphorylation was not affected. The similarity in the extent of inhibition in the non-cyclic electron flow and non-cyclic photophosphorylation indicates that the effect of SO<sub>2</sub> is mainly due to inactivation of the electron transfer component located in photosystem II but not to its action on the energy-conversion processes. Further support for this conclusion was obtained from the result of the light-induced pH change by chloroplasts in the presence of PMS. With SO<sub>2</sub> fumigation, the extent of H<sup>+</sup> uptake, the rate of H<sup>+</sup> efflux and the half-recovery time of the H<sup>+</sup> change were not significantly affected, but electron flow from H<sub>2</sub>O to DCIP was remarkably inhibited (Fig. 2).

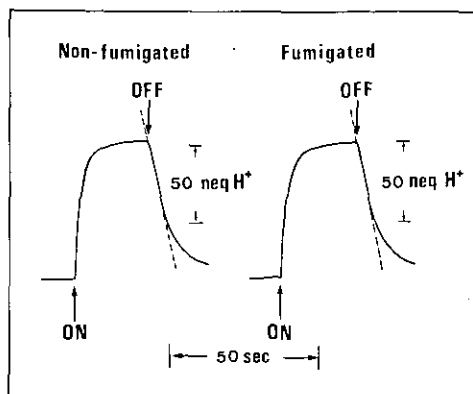

Fig. 2. Effects of  $\text{SO}_2$  fumigation on light-induced pH change in the presence of PMS. Fumigation was performed for 5 hr at 2.0 ppm of  $\text{SO}_2$ . The reaction mixture contained in 6 ml, 100 mM sucrose, 75 mM KCl, 4 mM  $\text{MgCl}_2$ , 0.03 mM PMS and 150  $\mu\text{g}$  chlorophyll as chloroplasts. Initial pH of the reaction mixture was adjusted to pH 6. Initial rates of  $\text{H}^+$  uptake were 690 and 600  $\mu\text{eq. H}^+ \cdot \text{mg chl}^{-1} \cdot \text{hr}^{-1}$  and those of  $\text{H}^+$  efflux were 250 and 220  $\mu\text{eq. H}^+ \cdot \text{mg chl}^{-1} \cdot \text{hr}^{-1}$  non-fumigated and fumigated samples, respectively. Extent of  $\text{H}^+$  uptake was 610 and 570 neq.  $\text{H}^+ \cdot \text{mg chl}^{-1}$  and half-recovery time ( $t_{1/2}$ ) were 5.1 and 5.2 sec, in non-fumigated and fumigated samples, respectively. However, the rates of DCIP photoreduction in the non-fumigated and fumigated samples were 134 and 65  $\mu\text{moles mg chl}^{-1} \cdot \text{hr}^{-1}$ , respectively.

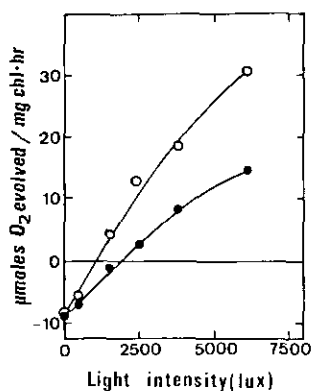

Fig. 3. Light dependence of  $\text{O}_2$  evolution at low light intensities before (o) or after (●) fumigation. Fumigation had been performed for 2 hr at 2.0 ppm of  $\text{SO}_2$ . Uptake and evolution of  $\text{O}_2$  were measured at 20°C by determining the amount of  $\text{O}_2$  dissolved in the bicarbonate medium in which the leaf was immersed. After  $\text{O}_2$  uptake of dark respiration became constant, the leaf was illuminated. On illumination, the rate of  $\text{O}_2$  evolution reached the constant values within 15 min. The steady-state rates of  $\text{O}_2$  uptake and evolution are presented in this figure. The reaction mixture (pH 7.0) contained in 25 ml, 38 mM phosphate buffer and 25 mM  $\text{NaHCO}_3$ . The photosynthetic activity was saturated at 20 mM of  $\text{NaHCO}_3$  and the optimum pH of the reaction mixture for  $\text{O}_2$  evolution was about 7.0 in spinach leaves (data not shown).

*Visible damage induced by SO<sub>2</sub>*

Chlorophyll in spinach leaves began to decompose at 4 to 5 hr after initiation of fumigation with 2.0 ppm SO<sub>2</sub>. During fumigation for 24 hr in light, interveinal chlorosis developed and finally showed SO<sub>2</sub>-injury similar to that observed under field conditions (5). On the other hand, fumigation in the dark induced only slight visible damage. Electron flow from H<sub>2</sub>O to DCIP in chloroplasts isolated from the dark-fumigated leaves was as active as that in the non-treated chloroplasts (data not shown).

*Effects of SO<sub>2</sub> on photosynthetic O<sub>2</sub> evolution in spinach leaves*

The results mentioned above clearly indicate that the activity of electron transport in chloroplasts was injured by SO<sub>2</sub> fumigation. The effect of SO<sub>2</sub> on O<sub>2</sub> evolution by spinach leaf was investigated next. Fig. 3 shows the light dependence curve of O<sub>2</sub> evolution in fumigated and non-fumigated leaves. Exposure of the leaves to 2.0 ppm SO<sub>2</sub> reduced the rate of light dependency in apparent O<sub>2</sub> evolution under light-limited conditions. In darkness a slight change in respiratory O<sub>2</sub> uptake was observed with SO<sub>2</sub> fumigation. The inhibitory effect of SO<sub>2</sub> seems to be more remarkable in the photosynthetic process than in mitochondrial respiration.

**Discussion**

The present investigation showed that SO<sub>2</sub> fumigation under illumination inhibited the activity of photosystem II but did not affect that of photosystem I. SO<sub>2</sub> inhibited both non-cyclic electron flow and photophosphorylation to the same extent but had no influence on the activity of cyclic photophosphorylation driven by photosystem I. Furthermore, in the presence of PMS, the extent of H<sup>+</sup> uptake, the rate of H<sup>+</sup> efflux and its half-recovery time were not affected by SO<sub>2</sub> fumigation. From these results, we concluded that SO<sub>2</sub> specifically suppressed the electron transfer in photosystem II and had no effect on the energy-transfer system.

During fumigation, SO<sub>2</sub> entering leaf tissue through the stomata produces H<sup>+</sup>, HSO<sub>3</sub><sup>-</sup> and SO<sub>3</sub><sup>2-</sup> in the cells. These substances accumulated in the cytoplasmic fluid and some are preferentially incorporated into the thylakoid membranes (29). Thus, the action of sulfite (HSO<sub>3</sub><sup>-</sup>, SO<sub>3</sub><sup>2-</sup>) on photosynthetic processes in chloroplasts has been studied under aqueous conditions as a model system of SO<sub>2</sub> phytotoxicity. In this line of studies, Asada et al. (2) demonstrated that the sulfite inhibited both cyclic and non-cyclic photophosphorylation without affecting the electron flow. Recently, Silvius et al. (18) showed that the sulfite inhibits both non-cyclic and cyclic photophosphorylation under acidic conditions. Apparently, the inhibitory effects of sulfite on the electron transport system in aqueous conditions in vitro are different from the effects of gaseous SO<sub>2</sub> observed in this study. The differences are probably due to the experimental conditions. For example, in the model system in vitro, measurements of electron transport were made in the presence of sulfite ions and illumination of chloroplasts with sulfite ions was done only during the measurement. It should be pointed out, however, that the phytotoxic effects of SO<sub>2</sub> are severe in light and in the case of leaf fumigation, chloroplasts are exposed to light with sulfite ions during fumigation. In order to observe the phytotoxic effects of SO<sub>2</sub> using a model system in vitro, the effects of sulfite on chloroplasts in light should be elucidated. We note that chloroplasts produce the superoxide anion (O<sub>2</sub><sup>-</sup>) by a one-electron reduction of molecular oxygen under illumination, and in the presence of sulfite, the O<sub>2</sub><sup>-</sup> formed initiates the sulfite oxidation



to yield a large number of radicals in a chain reaction (1).

Most of the  $\text{SO}_2$  absorbed through stomata is converted into sulfate by oxidation enzymatically and non-enzymatically (20). Sulfate accumulation takes place in plants exposed to  $\text{SO}_2$  (9). Sulfate is known to irreversibly inhibit both cyclic and non-cyclic photophosphorylation by affecting the coupling factor of chloroplast thylakoids (16). The observed effect on photophosphorylation caused by  $\text{SO}_2$  fumigation was different from the effect of sulfate. Sulfate probably is not the toxic substance responsible for the phytotoxic effects of  $\text{SO}_2$  on the photosynthetic processes.

The present study also showed a reduction in the slope of the light dependence curve of  $\text{O}_2$  evolution in fumigated leaves under light-limited conditions. A similar inhibitory effect has been reported for photosynthetic  $\text{CO}_2$  fixation of rice plants after fumigation with various concentrations of  $\text{SO}_2$  by Taniyama et al. (22). The photosynthetic electron transport system, which supplies ATP and NADPH<sub>2</sub> for the  $\text{CO}_2$  fixation system, mainly limits the whole process of photosynthesis under light-limited conditions. Consequently, the decrease in the rate of  $\text{O}_2$  evolution represents alterations in the activity of photosynthetic electron transport in leaves. This implies that at least one of the sites injured by  $\text{SO}_2$  fumigation in leaves is within photosystem II. It should be pointed out, however, that the present data do not exclude the possibility that the Calvin cycle enzymes in leaves are also inactivated by  $\text{SO}_2$  fumigation (15, 28, 30).

The effects of air pollutants such as ozone (7) and peroxyacetylnitrate (8) on the photosynthetic electron transport system have been investigated. Bubbling of these gases through a chloroplast suspension results in non-specific inhibition of the activities of both photosystems I and II. Thus, the specific inhibitory action of  $\text{SO}_2$  on photosystem II indicated in this study is noteworthy. The site and mode of  $\text{SO}_2$  inhibition in photosystem II are presented in the accompanying paper (17).

We wish to thank Prof. M. Nishimura, Kyushu University, for his kind guidance and his critical reading of the manuscript. We also wish to thank Dr. T. Oku, Kyushu University, for his helpful advice and valuable criticism in the course of this experiment. This work was supported in part by a grant from the Environment Agency.

#### References

1. Asada, K. and K. Kiso: Initiation of aerobic oxidation of sulfite by illuminated spinach chloroplasts. *Eur. J. Biochem.* 33:253-257 (1973).
2. Asada, K., S. Kitoh, R. Deura and Z. Kasai: Effect of  $\alpha$ -hydroxysulfonates on photochemical reactions of spinach chloroplasts and participation of glycolate in photophosphorylation. *Plant & Cell Physiol.* 6:615-629 (1965).
3. Avron, M.: Photophosphorylation by swiss-chard chloroplasts. *Biochim. Biophys. Acta* 40:257-272 (1960).
4. Ballantyne, D. T.: Sulphite oxidation by mitochondria from green and etiolated peas. *Phytochemistry* 16:49-50 (1977).
5. Barrett, T. W. and H. M. Benedict: Sulfur dioxide. In *Recognition of Air Pollution Injury to Vegetation: A Pictorial Atlas*. Edited by J. S. Jacobson and A. C. Hill, p.C 1-C 17. Air Pollution Control Association, Pittsburgh, Pennsylvania, 1970.
6. Bell, J. N. B. and C. H. Mudd: Sulfur dioxide resistance in plants: A case study of *Lolium perenne*. In *Effects of Air Pollutants on Plants*. Edited by T. A. Mansfield, p.87-107. Cambridge University Press, Cambridge, 1976.
7. Coulson, C. and R. L. Heath: Inhibition of the photosynthetic capacity of isolated chloroplasts by ozone. *Plant Physiol.* 53:32-38 (1974).
8. Coulson, C. and R. L. Heath: The interaction of peroxyacetylnitrate (PAN) with the electron

## Inhibition of photosystem II with SO<sub>2</sub> fumigation

- flow of isolated chloroplasts. *Atmospheric Environment* 9:231–238 (1975).
9. Garsed, S. G. and D. J. Read: Sulphur dioxide metabolism in soy-bean, *Glycine Max* var. Biloxi II. Biochemical distribution of <sup>35</sup>S SO<sub>2</sub> products. *New Phytol.* 99:583–592 (1977).
  10. Hill, G. R. and M. D. Thomas: Influence of leaf destruction by sulphur dioxide and by clipping on yield of alfalfa. *Plant Physiol.* 8:223–245 (1933).
  11. Jones, H. G. and C. B. Osmond: Photosynthesis by thin leaf slices in solution. I. Properties of leaf slices and comparison with whole leaves. *Aust. J. Biol. Sci.* 26:15–24 (1973).
  12. Kondo, N. and K. Sugahara: Changes in transpiration rate of SO<sub>2</sub>-resistant and -sensitive plants with SO<sub>2</sub> fumigation and the participation of abscisic acid. *Plant & Cell Physiol.* 19:365–373 (1978).
  13. Mackinney, G.: Absorption of light by chlorophyll solutions. *J Biol. Chem.* 140:315–322 (1941).
  14. Malhotra, S. S.: Effects of sulphur dioxide on biochemical activity and ultrastructural organization of pine needle chloroplasts. *New Phytol.* 76: 239–245 (1976).
  15. Paul, J. S. and J. A. Bassham: Effects of sulfite on metabolism in isolated mesophyll cells from *Papaver somniferum*. *Plant Physiol.* 62:210–214 (1978).
  16. Ryrie, I. J. and A. T. Jagendorf: Inhibition of photophosphorylation in chloroplasts by inorganic sulfate. *J. Biol. Chem.* 246:582–588 (1971).
  17. Shimazaki, K. and K. Sugahara: Inhibition site in electron transport system in chloroplasts by fumigation of lettuce leaves with SO<sub>2</sub>. In this Research Report.
  18. Silvius, J. E., M. Ingle and C. H. Baer: Sulfur dioxide inhibition of photosynthesis in isolated chloroplasts. *Plant Physiol.* 56:434–437 (1975).
  19. Tagawa, K. and D. I. Arnon: Ferredoxins as electron carriers in photosynthesis and in the biological production and consumption of hydrogen gas. *Nature* 195:537–543 (1962).
  20. Tager, J. M. and N. Rautanen: Sulfite oxidation by a plant mitochondrial system. Enzymatic and nonenzymatic oxidation. *Physiol Plant.* 9:665–673 (1956).
  21. Tanaka, H., T. Takanashi and M. Yatazawa: Experimental studies on SO<sub>2</sub> injuries in higher plants. I. Formation of glyoxylate-bisulfite in plant leaves exposed to SO<sub>2</sub>. *Water Air Soil Pollut.* 1:205–211 (1972).
  22. Taniyama, T., H. Arikado, Y. Iwata and K. Sawanaka: Studies on the mechanism of injurious effects of toxic gases on crop plants. *Proc. Crop Sci. Japan* 41:120–125 (1972).
  23. Taylor, O. C.: Acute responses of plants to aerial pollutants. In *Air Pollution Damage to Vegetation*. Edited by J. A. Naegele. p.9–20. Academic Chemical Society, Washington, D. C., 1973.
  24. Thomas, M. D., R. H. Hendricks, T. R. Collier and G. R. Hill: The utilization of sulfate and sulfur dioxide for the nutrition of alfalfa. *Plant Physiol.* 18:345–371 (1943).
  25. Thomas, M. D. and G. R. Hill: Absorption of sulphur dioxide by alfalfa and its relation to leaf injury. *ibid.* 10:291–307 (1935).
  26. Wellburn, A. R., O. Majernik and F. M. N. Wellburn: Effects of SO<sub>2</sub> and NO<sub>2</sub> polluted air upon the ultrastructure of chloroplasts. *Environ. Pollut.* 3:37–49 (1972).
  27. Yamashita, T., H. Kohda, J. Nanri and G. Tomita: The simultaneous measurement of O<sub>2</sub>-evolving and CO<sub>2</sub>-fixing activities in fresh leaves. *J. Fac. Agr., Kyusyu Univ.* 22:107–118 (1978).
  28. Ziegler, I.: The effect of SO<sub>3</sub><sup>-</sup> on the activity of ribulose-1, 5-diphosphate carboxylase in isolated spinach chloroplasts. *Planta* 103: 155–163 (1972).
  29. Ziegler, I.: Subcellular distribution of <sup>35</sup>S sulfur in spinach leaves after application of <sup>35</sup>SO<sub>4</sub><sup>2-</sup>, <sup>35</sup>SO<sub>3</sub><sup>2-</sup>, and <sup>35</sup>SO<sub>2</sub>. *ibid.* 135:25–32 (1977).
  30. Ziegler, I. and W. Libera: The enhancement of CO<sub>2</sub> fixation in isolated chloroplasts by low sulfite concentrations and by ascorbate. *Z Naturforsch.* 30 C:643–647 (1975).

## Inhibition site in electron transport system in chloroplasts by fumigation of lettuce leaves with SO<sub>2</sub>

Ken-ichiro Shimazaki and Kiyoshi Sugahara

Division of Environmental Biology, The National Institute for Environmental Studies,  
Yatabe, Ibaraki 305

Electron flow from water to 2,6-dichloroindophenol (DCIP) was inhibited but electron flow from reduced DCIP to methyl viologen (MV) was not affected in chloroplasts isolated from SO<sub>2</sub>-fumigated leaves. Diphenylcarbazide (DPC) or MnCl<sub>2</sub> could not restore the activity of the DCIP-Hill reaction of SO<sub>2</sub>-inhibited chloroplasts. Electron flows, from water to ferricyanide or to silicomolybdic acid (SM) in the presence of DCMU, were inhibited in a degree similar to that of the DCIP-Hill reaction.

The rate of carotenoid photobleaching in the presence of carbonyl cyanide-*m*-chlorophenylhydrazine (CCCP) was suppressed in parallel with the inhibition of the DCIP-Hill reaction.

The extent of variable part in the fluorescence transient was diminished in SO<sub>2</sub>-inhibited chloroplasts. The fluorescence yield, lowered by SO<sub>2</sub> fumigation, was increased on addition of DCMU or more pronouncedly by incubating the sample with sodium dithionite but could not recover to the yield of non-fumigated chloroplasts. The time required to reach steady-state level of fluorescence became longer in the absence of DCMU but the time was not altered in the presence of DCMU. The pool size of the primary electron acceptors determined in the presence of DCMU decreased with SO<sub>2</sub> fumigation. From these results we concluded that SO<sub>2</sub> inactivated the primary electron donor or reaction center itself. The mode of SO<sub>2</sub> action in the electron transport chain is also discussed.

**Key words:** Chloroplasts – effect of SO<sub>2</sub> – electron transfer – photosystem II – photosynthesis – sulfur dioxide

Sulfur dioxide, a major atmospheric pollutant, causes various damages to plants such as chlorosis and necrosis (22, 8, 13, 17, 25). When plants are fumigated with SO<sub>2</sub>, the toxicant entering the leaf tissue is preferentially incorporated into thylakoid membranes (31) and induces swelling (28) or disintegration of the membranes (15). Recently, we have shown that SO<sub>2</sub> fumigation suppressed the photosynthetic O<sub>2</sub> evolution severely but did not affect the respiratory O<sub>2</sub> uptake in spinach leaves (20). We also have demonstrated that SO<sub>2</sub> inhibits the activity of photosystem II without affecting the energy-converting process during the fumigation (20). However, the site of SO<sub>2</sub> action in the

Abbreviations: DCIP, 2,6-dichloroindophenol; DCMU, 3-(3', 4'-dichlorophenyl)-1, 1-dimethylurea; CCCP, carbonyl cyanide-*m*-chlorophenylhydrazine; DPC, diphenylcarbazide; MV, methyl viologen; PQ, plastoquinone; SM, silicomolybdic acid

A part of this study has been published in; *Plant & Cell Physiology* 21: No. 1 (1980)

vicinity of photosystem II has not been clarified.

The present study was, therefore, undertaken to provide more information on the site of SO<sub>2</sub>-inhibition in electron transport chain through the analysis of electron transfer and chlorophyll *a* fluorescence in chloroplasts isolated from the SO<sub>2</sub>-fumigated leaves of lettuce. Evidence was obtained that SO<sub>2</sub> inactivated the electron transfer at the site close to the reaction center of photosystem II.

### Materials and methods

#### *Plant material and conditions for SO<sub>2</sub> fumigation*

Lettuce (*Lactuca sativa* L. var. Romaine) plants were grown in a glass house under sunlight. Plants, 6–8 weeks old, were fumigated at 2.0 ppm (v/v) of SO<sub>2</sub> in a growth cabinet at 20°C. The light intensity was 25,000–35,000 lux at the leaf level during fumigation. Other conditions for growth and fumigation were the same as reported previously (20). After fumigation of lettuce plants, chloroplasts were prepared according to the method described previously (20).

#### *Activities of electron transfer*

The rate of DCIP photoreduction was determined by following the absorbance decrease at 590 nm with a Hitachi 556 spectrophotometer. The reaction mixture contained, in 4 ml, 14 mM Tricine-NaOH (pH 7.5), 110 mM sucrose, 50 μM DCIP and 20 μg of chlorophyll as chloroplasts.

The rate of O<sub>2</sub> exchange was determined using a Clark-type oxygen electrode. The basal reaction mixture contained, in 6 ml, 58 mM Tricine-NaOH (pH 7.5), 67 mM sucrose, 0.5 mM ferricyanide and 200 μg of chlorophyll as chloroplasts. For the measurement of O<sub>2</sub> evolution in the presence of DCMU, 1.1 mg silicomolybdic acid and 7 μM DCMU were also added to the basal reaction mixture. For the measurement of photosystem I-driven O<sub>2</sub> uptake, 0.1 mM methyl viologen, 1 mM sodium azide, 150 μM DCIP, 2 mM sodium ascorbate and 7 μM DCMU were added to the ferricyanide free basal reaction mixture.

#### *Carotenoid photobleaching*

CCCP-induced carotenoid photobleaching was measured, using a Hitachi 556 dual wavelength spectrophotometer, at 490 nm-minus-540 nm in the dual wavelength mode in a four-sided transparent cell (1 × 1 × 4 cm). The reaction mixture contained, in 4 ml, 67 mM phosphate buffer (pH 7.0), membrane fragments equivalent to 40 μg of chlorophyll and 100 μM CCCP.

Actinic light for the measurement of absorbance changes was obtained from a 100 W iodine lamp; the light was passed through a red cut-off filter (Corning 2403, >620 nm) and a 7 cm layer of water. The light intensity was  $2 \times 10^5$  ergs·cm<sup>-2</sup>·sec<sup>-1</sup>, measured with a radiometer (Lambda Instrument, Model LI-185) on the surface of the cuvette. A light blue filter (Corning 9782) was used to shield the photomultiplier.

#### *Chlorophyll *a* fluorescence*

A suspension of chloroplasts in a four-sided transparent cell was illuminated by a 100 W iodine lamp operated on a d.c. stabilizer; the light was passed through a glass filter (Corning 9782). The reaction mixture contained 12.5 mM Tricine-NaOH (pH 7.5), 100 mM sucrose, 5 mM NaCl and 10 μg of chlorophyll as chloroplasts in 4 ml. The light intensity was controlled by varying the voltage supplied to lamp. The fluorescence

emitted in the right angle to the actinic light was detected by a photomultiplier (Hitachi R-375) combined with a red cut-off filter (Corning 2030, > 650 nm) and an interference filter (Maximum transmittance 683 nm, half band width 10 nm.) The signal from the photomultiplier was amplified and recorded on a strip chart recorder (Yokogawa Technicorder F Model 3052) or a rapid digital transient recorder (Kawasaki Electronica Model TM-1410).

Chlorophyll concentrations were determined by using the absorption coefficients of Mackinney (14). All measurements were carried out at 20°C–22°C. Silicomolybdc acid was kindly provided by Prof. M. Nishimura, Kyusyu University.

## Results

### *Effects of SO<sub>2</sub> on the activities of electron transfer*

Electron transfer from water to DCIP was inhibited, whereas electron transfer from reduced DCIP to methyl viologen was not affected in chloroplasts isolated from SO<sub>2</sub>-fumigated leaves of lettuce (Table 1). This indicates that SO<sub>2</sub> inactivates the reactions driven by photosystem II but not those by photosystem I in electron transport chain. The result confirms our previous report on a study using spinach plants (20).

The rate of DCIP photoreduction inhibited by SO<sub>2</sub> could not be recovered by the addition of diphenylcarbazine (DPC), an artificial electron donor for photosystem II (27) (Table 1). MnCl<sub>2</sub> at 1 mM, an electron donor for photosystem II, also was without effect (data not shown). Ineffectiveness of DPC or MnCl<sub>2</sub> in restoring the DCIP-Hill reaction indicates that the site of SO<sub>2</sub> action is located closer to the reaction center of photosystem II than the donation site of these artificial donors or on the reducing side of photosystem II.

The O<sub>2</sub> evolution supported by ferricyanide in chloroplasts was inhibited by SO<sub>2</sub> fumigation (Fig. 1) and that of DCIP photoreduction was inhibited to the same extent (data not shown). When 7 μM DCMU was added to the SO<sub>2</sub>-inhibited chloroplasts, O<sub>2</sub> evolution was suppressed completely. However, further addition of silicomolybdc acid, a lipophilic electron acceptor of system II (3, 5), restored the Hill reaction up to the original values determined in the absence of DCMU (Fig. 1). No stimulative effect of silicomolybdc acid in O<sub>2</sub> evolution was observed. Thus, the site inactivated by SO<sub>2</sub> fumigation, which is responsible for the inhibition of the DCIP-Hill reaction, would not be located in the reducing side of the primary electron acceptor of

Table 1 *Effects of SO<sub>2</sub> on electron transport activities and effect of DPC on SO<sub>2</sub>-inhibited DCIP-Hill reaction*

Reaction measured	SO <sub>2</sub> fumigation (hr)			
	0	2	3	5
H <sub>2</sub> O→DCIP (μmoles DCIP reduced/mg chl·hr)	148	86	45	13
H <sub>2</sub> O→DCIP (+DPC) <sup>a</sup> (μmoles DCIP reduced/mg chl·hr)	166	93	49	15
DCIPH <sub>2</sub> →MV (+DCMU) (μmoles O <sub>2</sub> uptake/mg chl·hr)	216	206	193	190

SO<sub>2</sub> fumigation was performed at 2.0 ppm.

<sup>a</sup>Diphenylcarbazine at 0.5 mM was added to the basal reaction mixture.

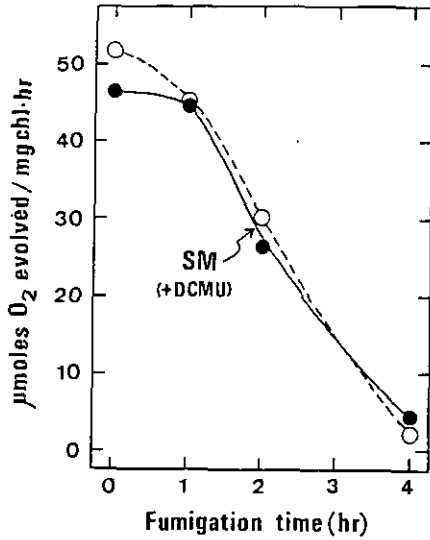

Fig. 1. Effects of  $SO_2$  on DCMU-sensitive and -insensitive  $O_2$  evolution. Rate of  $O_2$  evolution in the absence of DCMU (—○—), rate of  $O_2$  evolution in the presence of both DCMU and silicomolybdc acid (—●—). Fumigation was performed at 2.0 ppm of  $SO_2$ . Silicomolybdc acid was added to the chloroplast suspension after addition of DCMU during the measurement under actinic light.

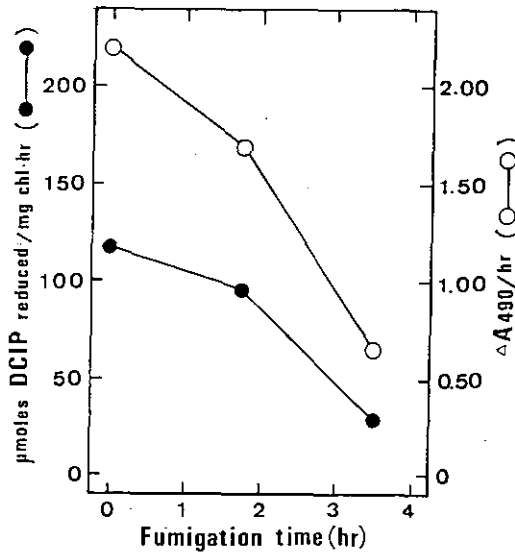

Fig. 2. Effects of  $SO_2$  on DCIP photoreduction and CCCP-induced carotenoid photo-bleaching. Initial rate of absorbance change at 490 nm in the presence of 100  $\mu M$  CCCP (—○—), rate of DCIP photoreduction (—●—).  $SO_2$  fumigation was carried out at 2.0 ppm.

## Inhibition site in photosystem II with SO<sub>2</sub> fumigation

photosystem II designated Q (4), since silicomolybdic acid is assumed to accept electrons, directly from Q (3, 5).

### *Effects of SO<sub>2</sub> on CCCP-induced carotenoid photobleaching*

Carotenoids are irreversibly bleached when chloroplasts are illuminated in the presence of CCCP, hydroxylamine or NaN<sub>3</sub> which inhibits electron transfer on the oxidizing side of photosystem II (29). However, these inhibitors do not affect the primary photoreaction of system II, and the rate of carotenoids photobleaching is closely related to the production of the oxidized component by system II reaction in the presence of the above inhibitors (11, 12, 29). Thus, the initial rate of carotenoids photobleaching induced by CCCP is an excellent indicator of photochemical reaction of system II (23). Figure 2 shows the effect of SO<sub>2</sub> on the initial rate of carotenoid photobleaching. The rate was suppressed in parallel with the inhibition of the DCIP-Hill reaction in SO<sub>2</sub>-inhibited chloroplasts. The result indicates that the site of SO<sub>2</sub> action in the electron transport chain is closer to the reaction center of photosystem II than the inhibition site of CCCP (12, 29).

### *Effect of SO<sub>2</sub> on the fluorescence transient*

The time course of fluorescence intensity showed the initial rapid rise to F<sub>i</sub>, then a gradual rise to attain a steady-state level, F<sub>s</sub>, as has been described by Murata et al. (18) and Malkin and Kok (16) (Fig. 3). It is generally accepted that a gradual increase in the

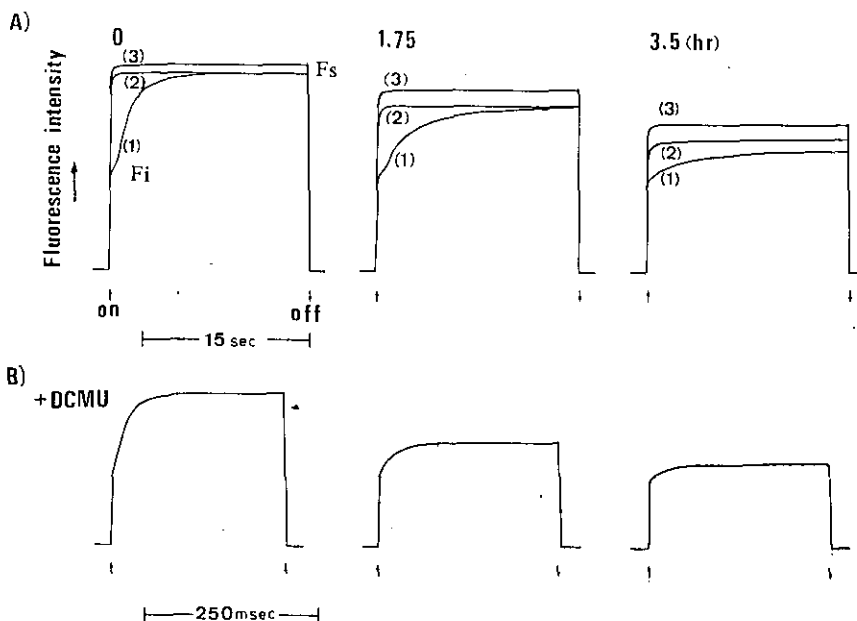

Fig. 3. *Effects of SO<sub>2</sub> on the time course of the fluorescence transient.* Fumigation was performed at 2.0 ppm of SO<sub>2</sub>. The lengths of fumigation periods are indicated at the top. Chloroplasts were incubated in the dark for 5 min before illumination. A: 1, no addition; 2, 10 μM DCMU; 3, 10 μM DCMU and a few grains of sodium dithionite. Actinic light intensity was 7,000 ergs/cm<sup>2</sup>·sec. The rates of DCIP photoreduction were 135, 87 and 35 μmoles/mg chlorophyll·hr for 0, 1.75 and 3.5 hr of SO<sub>2</sub> fumigation, respectively. B: Fluorescence induction was recorded by a digital transient recorder in the presence of DCMU. Actinic light intensity was 15,000 ergs/cm<sup>2</sup>·sec.

fluorescence yield corresponds to an accumulation of the reduced primary electron acceptor, Q (4, 16, 18).

Effect of  $\text{SO}_2$  was prominent on the variable part of fluorescence induction. The extent of the variable part of fluorescence ( $F_s - F_i$ ) was reduced markedly but only a slight change was observed in the level of  $F_i$  (Fig. 3). The time required to reach the steady level ( $F_s$ ) also became longer with increasing time of  $\text{SO}_2$  fumigation (Table 2). The results indicates that  $\text{SO}_2$  inhibited the accumulation of reduced Q.

Table 2 Effect of  $\text{SO}_2$  on the half-rise time of variable fluorescence in the presence and absence of DCMU.

	Half-rise time ( $t_{1/2}$ )			Intensity of actinic light (ergs/cm <sup>2</sup> ·sec)
	SO <sub>2</sub> fumigation time <sup>a</sup> (hr)			
	0	1.5	3.0	
-DCMU <sup>b</sup>	0.81	1.3	2.4 (sec)	7,000
+DCMU <sup>c</sup>	52	53	56 (msec)	7,000

<sup>a</sup>Fumigation was performed at 2.0 ppm of  $\text{SO}_2$ .

<sup>b</sup>The activities of DCIP photoreduction were 178, 104 and 38  $\mu\text{moles/mg chlorophyll}\cdot\text{hr}$  for 0, 1.5 and 3.0 hr of  $\text{SO}_2$  fumigation, respectively.

<sup>c</sup>In the presence of 10  $\mu\text{M}$  DCMU, the transient phase in fluorescence induction was recorded with a digital transient recorder.

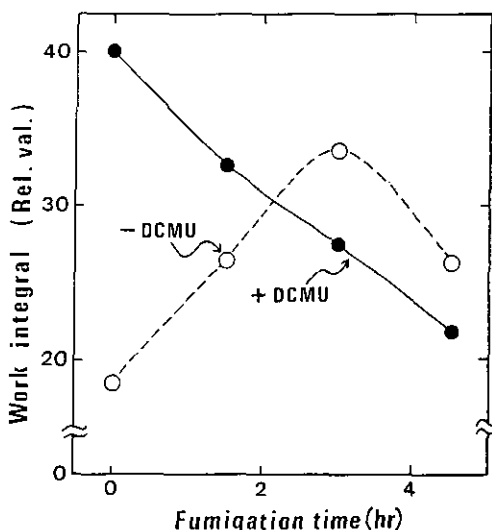

Fig. 4. Effects of  $\text{SO}_2$  on pool sizes of electron acceptors in the presence and absence of DCMU. Relative pool size of electron acceptors determined in the absence of DCMU (○-○-), and in the presence of DCMU (-●-). Different ordinate scales apply for values of work integral in the presence and absence of DCMU (cf. Fig. 3). Fumigation was performed at 2.0 ppm of  $\text{SO}_2$ . Chloroplasts were incubated in the dark for 5 min before illumination. Light intensity at the position of the sample cuvette was approximately, 7,000 ergs/cm<sup>2</sup>·sec. For details, see text.



## Inhibition site in photosystem II with SO<sub>2</sub> fumigation

On addition of DCMU, the fluorescence showed a rapid rise and the steady level was significantly increased in SO<sub>2</sub>-inhibited chloroplasts (Fig. 3). This suggests that Q remained in the oxidized state during the measurement of fluorescence in the absence of DCMU. In order to follow the variable part of fluorescence in the presence of DCMU, the time course of fluorescence was traced with a transient recorder. The transient phase was diminished and fluorescence yield was decreased with SO<sub>2</sub> fumigation (Fig. 3, B). However, the time required to reach the steady level was unaltered by SO<sub>2</sub> fumigation suggesting that the photoreduction of Q was almost complete within the same time as the control. The time required for 50% increase of fluorescence during the transient phase, measured at two different light intensities (7,000 and 15,000 ergs·cm<sup>-2</sup>·sec<sup>-1</sup>), was not changed by SO<sub>2</sub> fumigation (Table 2 and unpublished data).

Fig. 4 shows the effect of SO<sub>2</sub> on the pool size of electron acceptors on the reducing side of photosystem II, expressed in terms of work integral of Murata et al. (18). The relative size of the pool measured from the transient phase on a chart recorder reached a maximum after fumigating leaves for a few hours and then decreased with fumigation time in the absence of DCMU (Fig. 4). In contrast, the pool size of the primary electron acceptor Q, measured from the transient phase on a transient recorder, decreased with time of SO<sub>2</sub> fumigation (Fig. 4). The decrease of the pool size of Q was accompanied by loss of the Hill reaction activity.

Variable fluorescence is restored when chloroplasts are kept in the dark. The

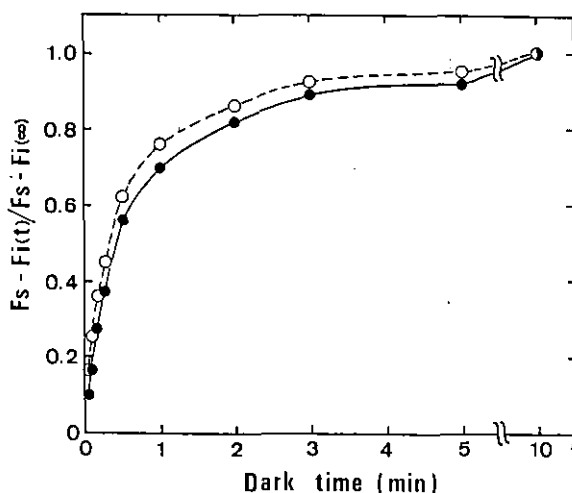

Fig. 5. Effects of SO<sub>2</sub> on dark recovery of fluorescence transient. Ratio of  $[F_s - F_i(t)]$  to  $[F_s - F_i(\infty)]$  in the control (—o—), in SO<sub>2</sub>-inhibited chloroplasts (—●—) against dark incubation time, where  $F_s$  is the fluorescence intensity at the steady level,  $F_i(\infty)$  is the fluorescence intensity of initial rapid rise at the onset of first illumination and  $F_i(t)$  is the fluorescence intensity of initial rapid rise after dark incubation of various length. Fumigation was performed at 2.0 ppm of SO<sub>2</sub>. Chloroplasts were illuminated first for 30 sec at 10,000 ergs after the dark incubation for 10 min. The second and the succeeding illuminations were given after the dark periods of various lengths. The rates of DCIP photoreduction were 154 and 51  $\mu$ moles/mg chlorophyll·hr for the control and SO<sub>2</sub>-inhibited chloroplasts, respectively. The time required for 50% increase of fluorescence ( $t_{1/2}$ ) in the transient phase were 1.4 and 3.7 sec for the control and SO<sub>2</sub>-inhibited chloroplasts, respectively.

reoxidation of photoreduced Q, through adjacent electron acceptors, proceeds during dark incubation. Figure 5 shows the effect of SO<sub>2</sub> on the dark recovery of transient fluorescence. The fluorescence induction of SO<sub>2</sub>-inhibited chloroplasts recovered similarly to the control and there was essentially no change of the dark time required for 50% increase of variable fluorescence (Fig. 5). The result suggests that the electron flow from Q to the large electron pool, presumably of plastoquinone, was not affected by SO<sub>2</sub> fumigation.

The effect of dithionite on the fluorescence induction was studied in SO<sub>2</sub>-inhibited chloroplasts. Incubation of the chloroplasts with dithionite for 3 min increased the steady level of fluorescence significantly. The increase in the steady-state fluorescence level by dithionite became larger with fumigation time (Fig. 3, A). This might indicate that the photoreduction of Q was blocked by SO<sub>2</sub> fumigation.

### Discussion

The results obtained in the present study indicate that SO<sub>2</sub> inhibited the electron transfer at the site close to the reaction center of photosystem II. SO<sub>2</sub> decreased the initial rate of carotenoid photobleaching in the presence of CCCP. SO<sub>2</sub> also inhibited the O<sub>2</sub> evolution in the presence of silicomolybdic acid. In the comparative studies on the action of electron transfer inhibitors in the vicinity of photosystem II, Kimimura et al. (12) and Katoh (11) showed that the pool size of Q was not changed by the addition of CCCP, NaN<sub>3</sub> or hydroxylamine. However, SO<sub>2</sub> decreased the pool size of Q. From these results we conclude that SO<sub>2</sub> inactivated the primary electron donor or the reaction center itself in electron transport chain.

SO<sub>2</sub> decreased the pool size of Q but did not alter the half-rise time ( $t_{1/2}$ ) in the variable fluorescence in the presence of DCMU. This suggests that the rate of photoreduction of Q was not altered by SO<sub>2</sub> in the operating electron transport chain. The main cause of SO<sub>2</sub>-inhibition in the Hill reaction is probably the decrease in number of the reaction center or the primary donor.

In the absence of DCMU, there was a marked prolongation of the variable part of fluorescence in SO<sub>2</sub>-inhibited chloroplasts indicating the slower accumulation of reduced Q. This is probably due to the decrease in the number of Q which can be photoreduced by system II reaction. If electron transfer from the photosystem II to the photosystem I proceeds independently in each of the isolated chains, no prolongation of the transient phase is expected. However, the pathways of electrons provided by photosystem II to the photosystem I can not be regarded as isolated chains. According to Stiehl and Witt (22), Siggel et al. (21) and Haehnel (7) electron exchanges take place between at least six electron chains through a common plastoquinone (PQ) pool. Recently, it was shown that reduced Q rapidly donate electrons to the pool of plastoquinone through the secondary acceptor (6). Thus in SO<sub>2</sub>-inhibited chloroplasts, it may take a longer time to reduce a large pool of plastoquinones by the photochemical reaction driven by the decreased number of functioning reaction centers of photosystem II and result in the prolongation of the transient phase. These data can be explained by the scheme presented in Fig. 6.

Other possibilities to explain the prolongation of the variable fluorescence are (a) a partial inhibition of electron flow from Q to PQ as observed at low concentration of DCMU (18,26). (b) an acceleration of the oxidation of the photoreduced endogenous electron pool. If one of these is the case in SO<sub>2</sub>-inhibited chloroplasts, stimulative or suppressive effect of the dark oxidation rate of Q would be expected. However, no

Inhibition site in photosystem II with SO<sub>2</sub> fumigation

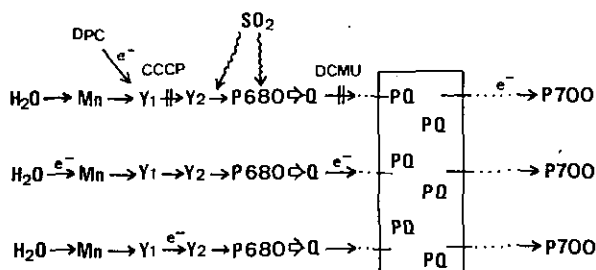

Fig. 6. A proposed scheme illustrating inhibitory site of SO<sub>2</sub> in electron transport system. The action site of inhibitors in the electron transport system and that of electron donors for photosystem II are also shown. Electron exchange is possible between different electron transport chains through the common pool of plastoquinone molecules. For details, see text.

essential change was observed in the rate of dark oxidation of Q.

The inhibitory action of SO<sub>2</sub> in the electron transport chain is unique and interesting as shown in the present investigation. When plants are fumigated with SO<sub>2</sub>, SO<sub>2</sub> entering leaf tissue through stomata produces HSO<sub>3</sub><sup>-</sup>, SO<sub>3</sub><sup>2-</sup> and H<sup>+</sup> in the cytoplasm. Sulfite formed is highly reactive with various organic substances such as, pyrimidines, disulfide and olefinic compounds (17). It also react with aldehyde to form  $\alpha$ -hydroxy-sulfonate, an inhibitor of glycolate oxidase, which is found in SO<sub>2</sub>-polluted plants (24). However, incubation of chloroplasts with sulfite or  $\alpha$ -hydroxysulfonate at neutral pH did not affect the activity of electron transport (1). The H<sup>+</sup> produced by SO<sub>2</sub> fumigation would lower the cytoplasmic pH. When chloroplasts were incubated at an acidic pH, the oxidizing side of photosystem II was inhibited but the activity could be restored by adding the electron donor of photosystem II (9, 10, 19). This is not the case for the inhibitory action of SO<sub>2</sub> on system II described above. The entities or situations which directly exert the irreversibly inhibitory action on photosystem II during SO<sub>2</sub> fumigation remains to be determined.

We wish to thank Prof. M. Nishimura, Kyushu University, for his critical reading of the manuscript and Dr. S. Katoh, University of Tokyo, for his kind guidance and invaluable criticism in the course of this experiment. We are also indebted to Dr. N. Kondo of our institute for his generous support and valuable criticism during this work and Dr. H. Shimizu of our institute for his helpful advice.

#### References

1. Asada, K., S. Kitoh, R. Deura and Z. Kasai: Effect of  $\alpha$ -hydroxysulfonate on photochemical reactions of spinach chloroplasts and participation of glycolate in photophosphorylation. *Plant & Cell Physiol.* 6: 615-629 (1965).
2. Barrett, T. W. and H. M. Benedict: Sulfur dioxide. In *Recognition of Air Pollution Injury to Vegetation: A Pictorial Atlas*. Edited by J. S. Jacobson and A. C. Hill, p.C 1-C 17. Air Pollution Control Association, Pittsburgh, Pennsylvania, 1970.

3. Barr, R., F.L. Crane and R.T. Giaquinta: Dichlorophenylurea-insensitive reduction of silicomolybdic acid by chloroplast photosystem II. *Plant Physiol.* 55: 46-462 (1975).
4. Duysens, L. N. M. and H. E. Sweers: Mechanism of two photochemical reactions in algae as studied by means of fluorescence. In *Studies on Microalgae and Photosynthetic Bacteria*. Edited by Japan Soc. Plant Physiol., p.353-372. University of Tokyo Press, Tokyo, 1963.
5. Giaquinta, R.T. and R.A. Dilley: A partial reaction in photosystem II: reduction of silicomolybdate prior to the site of dichlorophenyldimethylurea inhibition. *Biochim. Biophys. Acta* 387: 288-305 (1975).
6. Govindjee and J. J. S. Van Rensen: Bicarbonate effects on the electron flow in isolated broken chloroplasts. *Biochim. Biophys. Acta* 505: 183-213 (1978).
7. Haehnel, W.: Electron transport between plastoquinone and chlorophyll A<sub>1</sub> in chloroplasts. II Reactions kinetics and the function of plastocyanin in situ. *Biochim. Biophys. Acta* 459: 418-441 (1977).
8. Hill, G. R. and M. D. Thomas: Influence of leaf destruction by sulphur dioxide and by clipping on yield of alfalfa. *Plant Physiol.* 8: 223-245 (1933).
9. Itoh, S. and M. Nishimura: pH dependent changes in the reactivity of the primary electron acceptor of system II in spinach chloroplasts to external oxidant and reductant. *Biochim. Biophys. Acta* 460: 381-391 (1977).
10. Katoh, S. and A. San Pietro: A comparative study of inhibitory action on oxygen-evolving system of various chemical and physical treatment of *Euglena* chloroplasts. *Arch. Biochem. Biophys.* 128: 378-386 (1968).
11. Katoh, S.: Inhibitors of electron transport associated with photosystem II in chloroplasts. *Plant & Cell Physiol.* 13: 273-286 (1972).
12. Kimimura, M., S. Katoh, I. Ikegami and A. Takamiya: Inhibitory site of carbonyl cyanide *m*-chlorophenylhydrazone in electron transfer system of chloroplasts. *Biochim. Biophys. Acta* 234: 92-102 (1971).
13. Kondo, N. and K. Sugahara: Changes in transpiration rate of SO<sub>2</sub>-resistant and -sensitive plants with SO<sub>2</sub> fumigation and participation of abscisic acid. *Plant & Cell Physiol.* 19: 365-373 (1978).
14. Mackinney, G.: Absorption of light by chlorophyll solutions. *J. Biol. Chem.* 140: 315-322 (1941).
15. Malhotra, S. S.: Effects of sulphur dioxide on biochemical activity and ultrastructural organization of pine needle chloroplasts. *New Phytol.* 76: 239-245 (1976).
16. Malkin, S. and B. Kok: Fluorescence induction studies in isolated chloroplasts. I. Number of components involved in the reaction and quantum yields. *Biochim. Biophys. Acta* 126: 413-432 (1966).
17. Mudd, J. B.: Sulfur dioxide. In *Responses of Plants to Air Pollution*. Edited by J. B. Mudd and T. T. Kozlowski. p. 9-22. Academic Press, New York, 1975.
18. Murata, N., M. Nishimura and A. Takamiya: Fluorescence of chlorophyll in photosynthetic systems. II. induction of fluorescence in isolated spinach chloroplasts. *Biochim. Biophys. Acta* 120: 23-33 (1966).
19. Pulles, M. P. J., H. J. Van Gorkom and G. A. M. Vershoor: Primary reactions of photosystem II at low pH. 2. Light-induced changes of absorbance and electron spin resonance in spinach chloroplasts. *Biochim. Biophys. Acta* 440: 98-106 (1976).
20. Shimazaki, K. and K. Sugahara: Specific inhibition of photosystem II activity in chloroplasts by fumigation of spinach leaves with SO<sub>2</sub>. *Plant & Cell Physiol.* 20: 947-955 (1979).
21. Siggel, U., G. Renger, H. H. Stiehl and B. Rumberg: Evidence for electronic and ionic interaction between electron transport chains in chloroplasts. *Biochim. Biophys. Acta* 256: 328-335 (1972).
22. Stiehl, H. H. and H. T. Witt: Quantitative treatment of the function of plastoquinone in photosynthesis. *Z. Naturforsch.* 24b: 1588-1598 (1969).
23. Suzuki, R. and Y. Fujita: Carotenoid photobleaching induced by the action of photosynthetic reaction center. II: DCMU-sensitivity. *Plant & Cell Physiol.* 18: 625-631 (1977).
24. Tanaka, H., T. Takanashi and M. Yatazawa: Experimental studies on SO<sub>2</sub> injuries in higher plants. I. Formation of glyoxylate-bisulfite in plant leaves exposed to SO<sub>2</sub>. *Water Air Soil Pollut.* 1: 205-211 (1972).
25. Taylor, O. C.: Acute responses of plants to aerial pollutions. In *Air Pollution Damage to Vegetation* Edited by J. A. Naegele. p. 9-20. Academic Chemical Society, Washington, D. C., 1973.

Inhibition site in photosystem II with SO<sub>2</sub> fumigation

26. Van Rensen, J.J.S., D. Wong and Govindjee: Characterization of the inhibition of photosynthetic electron transport in pea chloroplasts by the herbicide 4,6-dinitro-*o*-cresol by comparative studies with 3-(3,4-dichlorophenyl)-1,1-dimethylurea. *Z. Naturforsch.* 33c: 413-420 (1978).
27. Vernon, L. P. and E. R. Shaw: Oxidation of 1,5-diphenylcarbazine as a measure of photosystem II activity in subchloroplasts fragments. *Biochem. Biophys. Res. Commun.* 36: 878-884 (1969).
28. Wellburn, A.R., O. Majernik and F.M.N. Wellburn: Effects of SO<sub>2</sub> and NO<sub>2</sub> polluted air upon the ultrastructure of chloroplasts. *Environ. Pollut.* 3: 37-49 (1972).
29. Yamashita, K., K. Konishi, M. Itoh and K. Shibata: Photobleaching of carotenoids related to the electron transport in chloroplasts. *Biochim. Biophys. Acta* 172: 511-524 (1969).
30. Yamashita, T. and W.L. Butler: Photooxidation by photosystem II of Tris-washed chloroplasts. *Plant Physiol.* 44:1342-1346 (1969).
31. Zjeler, I.: Subcellular distribution of <sup>35</sup>S sulfur in spinach leaves after application of <sup>35</sup>SO<sub>4</sub><sup>2-</sup>, <sup>35</sup>SO<sub>3</sub><sup>2-</sup>, and <sup>35</sup>SO<sub>2</sub>. *Planta* 135:25-32 (1977).
32. Zilinkas, B.A. and Govindjee: Silicomolybdate and silicotungstate mediated dichlorophenyl-dimethylurea-insensitive photosystem II reaction: electron flow, chlorophyll *a* fluorescence and delayed light emission changes. *Biochim. Biophys. Acta* 387: 306-319 (1975).

## Active oxygen participation in chlorophyll destruction and lipid peroxidation in SO<sub>2</sub>-fumigated leaves of spinach

Ken-ichiro Shimazaki, Takeshi Sakaki and Kiyoshi Sugahara

Division of Environmental Biology, The National Institute for Environmental Studies,  
Yatabe, Ibaraki 305

Chlorophyll *a* and carotenoids of spinach plants began to be destroyed in 2 to 3 hr after the initiation of fumigation with 2.0 ppm sulfur dioxide (SO<sub>2</sub>) in light, whereas chlorophyll *b* was apparently undamaged during 8 hr of exposure to SO<sub>2</sub>. The content of pheophytin *a*, chromatographically determined, was not changed by SO<sub>2</sub> fumigation.

When leaf disks ( $\phi=10$  mm), excised from the leaves fumigated with SO<sub>2</sub> at 2.0 ppm for 2 hr, were illuminated, chlorophyll *a* and carotenoids were broken down, but they were not destroyed in darkness. The destruction of chlorophyll *a* and carotenoids was suppressed under a stream of nitrogen. Chlorophyll *a* destruction was inhibited by free radical scavengers, 1,2-dihydroxybenzene-3,5-disulfonate (tiron), hydroquinone and ascorbate. The singlet oxygen scavengers, 1,4-diazabicyclo-[2,2,2]-octane (DABCO), methionine and histidine, and hydroxyl radical scavengers, benzoate and formate were without effect on the destruction of chlorophyll *a*. Chlorophyll *a* destruction was inhibited by the addition of superoxide dismutase (SOD) to the homogenate of SO<sub>2</sub>-fumigated leaves. SO<sub>2</sub> fumigation for 2 hr reduced the activity of superoxide dismutase to 40% without producing the significant loss of chlorophyll. From these results we concluded that chlorophyll *a* destruction by SO<sub>2</sub> was due to superoxide radicals.

Moreover, malondialdehyde (MDA), an indicator of lipid peroxidation, was accumulated in SO<sub>2</sub>-fumigated leaves in light. MDA formation was inhibited by tiron and hydroquinone, and by DABCO but was not inhibited by benzoate and formate. MDA formation was increased by D<sub>2</sub>O. From these results it was concluded that <sup>1</sup>O<sub>2</sub> had the immediate relation with the cause of lipid peroxidation in SO<sub>2</sub>-fumigated leaves. **Key words:** Carotenoid destruction - chlorophyll destruction - effect of SO<sub>2</sub> - lipid peroxidation - oxygen toxicity - sulfur dioxide.

Exposure of plants to sulfur dioxide, a widespread air pollutant, causes chlorosis and necrosis (6, 15, 24, 32, 36, 37), which are prominent phytotoxic effects of SO<sub>2</sub>. A number of workers reported the injurious effects of SO<sub>2</sub> on photosynthetic pigments in many species of plants (19, 29, 31, 37).

Illuminated chloroplasts produce O<sub>2</sub><sup>-</sup> on the surface of the thylakoid membranes (2, 3, 9). The formation of O<sub>2</sub><sup>-</sup> *in vivo* was also shown by Radmer and Kok (30) under illumination. In plant leaf cells, O<sub>2</sub><sup>-</sup> can be the major source of the other active oxygens

---

Abbreviations: BSA, bovine serum albumin; DABCO, 1,4-diazabicyclo-[2,2,2]-octane; MDA, malondialdehyde; MV, methyl viologen; PMS, phenazine methosulfate; SOD, superoxide dismutase; <sup>1</sup>O<sub>2</sub>, singlet molecular oxygen; tiron, 1,2-dihydroxybenzene-3,5-disulfonate

such as  $^1\text{O}_2$ ,  $\text{H}_2\text{O}_2$  and  $\text{OH}\cdot$  (4). These active oxygens are highly reactive with various cell components (1, 6, 7, 8, 9, 10, 13, 35). However, endogenous scavengers or quenchers in chloroplasts lower the steady state concentrations of active oxygens and protect chloroplasts from the toxicity of active oxygens (4).

Recently, Asada et al. (2) demonstrated that once  $\text{O}_2^-$  was formed on the thylakoid membranes under illumination, the  $\text{O}_2^-$  initiated the aerobic oxidation of sulfite in a chain reaction to yield a larger number of active oxygens than those were formed in the absence of sulfite. More recently, Ziegler (38) showed that when  $\text{SO}_2$  was applied to plant leaves by fumigation, the sulfite which was produced in cytoplasm was preferentially incorporated into thylakoid membranes rather than the stroma. Thus, during  $\text{SO}_2$  fumigation, it seems likely that increased amounts of  $\text{O}_2^-$  and its derived products could, at least partly, be responsible for the phytotoxic effects of  $\text{SO}_2$ .

In the present study, the effects of  $\text{SO}_2$  on the photosynthetic pigments and lipid were examined with special reference to the oxygen toxicity. The results indicated that chlorophyll *a* was destroyed by  $\text{O}_2^-$  and its derived product,  $^1\text{O}_2$ , was the proximate cause of lipid peroxidation in  $\text{SO}_2$ -fumigated leaves of spinach.

### Materials and methods

#### *Plant materials*

Spinach (*Spinacia oleracea* L. cv. New Asia) plants were grown in phytotron green house as described previously (33). Spinach used for fumigation were 4–6 weeks old.

#### *SO<sub>2</sub> fumigation*

Spinach plants were fumigated with 2.0 ppm (v/v)  $\text{SO}_2$  in a growth cabinet at 20°C in the morning as described previously (15). The light intensity was 25,000–35,000 lux at leaf level.

#### *The determination of photosynthetic pigments*

For the chromatographic separation, pigments were extracted completely from the leaf disks with ice-cold absolute acetone in glass homogenizer. The acetone extract, which was obtained by filtering through a glass filter, was transferred to peroxide-free diethyl ether in a separatory funnel and washed with 10% NaCl solution several times. The extract, dried with a powder of  $\text{Na}_2\text{SO}_4$ , was subjected to thin-layer chromatography on a microcrystalline cellulose plate (20 × 20 cm, Avicel SF) in an ascending manner with hexane:acetone (90:10, v/v). Chlorophyll *a* and *b*, and pheophytin *a* separated on thin-layer chromatogram were eluted in diethyl ether. The pigments were determined spectrophotometrically using the absorption coefficients of French (11). Total carotenoid was estimated by the saponification method according to Liaaen-Jensen and Jensen (16). The contents of chlorophylls and carotenoids in 80% acetone extracts were also determined by the methods of Mackinney (18), and Kirk and Allen (14), respectively. Absorption spectra were recorded with a Hitachi 556 dual wavelength spectrophotometer or with a Hitachi 200 spectrophotometer.

#### *Illumination of SO<sub>2</sub> fumigated leaves*

Seven leaf disks ( $\phi=10$  mm), excised from leaves fumigated with  $\text{SO}_2$  at 2.0 ppm for 2 hr, were floated on 40 mM phosphate buffer (PH 6.0) in Petri dishes ( $\phi=45$  mm) which were thermostatted at 20°C by running water. Illumination was provided by 5 tungsten lamps through 7 cm layer of water perpendicular to the surface of leaf disks. The light intensity was 30,000 to 32,000 lux at the leaf surface. Active oxygen scavengers or other reagents

dissolved in 40 mM phosphate buffer (pH 6.0) were added to the leaf disks by vacuum infiltration. Pure D<sub>2</sub>O was added instead of phosphate buffer. Superoxide dismutase at 1 mg/ml was added to the leaf homogenate.

#### *Assay of lipid peroxidation*

Lipid peroxidation was estimated by the malondialdehyde formation according to the method of Heath and Packer (12). Three ml of the leaf homogenate in distilled water was mixed with 5 ml of 0.5 % thiobarbituric acid in 20 % trichloroacetic acid. The mixture was incubated at 95°C in water-bath for 30 min. MDA formation was determined spectrophotometrically for the supernatant obtained from centrifugation of the mixture using the difference millimolar absorption coefficient,  $\Delta\epsilon_{\text{mM}}(532-600 \text{ nm}) = 155$  (12).

#### *Assay of superoxide dismutase*

After SO<sub>2</sub> fumigation for 2 hr, leaf disks ( $\phi=10$  mm) were excised and were illuminated further for the periods indicated. The leaf disks were homogenized in 0.1 M potassium phosphate (pH 7.8) with a Polytron (kinematica PT 10/35) at 4°C. The supernatants obtained from the centrifugation were dialyzed against 10 mM phosphate buffer overnight (pH 7.8). After centrifugation of dialysates at 15,000 × g for 30 min, the supernatants were used for the assay of the activity of superoxide dismutase. SOD was assayed by the inhibition of cytochrome *c* reduction by O<sub>2</sub><sup>-</sup> according to McCord and Fridovich (30) with a slight modification. The cytochrome *c* reduction was followed by the absorbance increase at 550 nm using a Hitachi 556 dual wavelength spectrophotometer. The reaction mixture, 1 ml, contained 50 mM potassium phosphate buffer (pH 7.8), 0.1 mM EDTA, 0.01 mM cytochrome *c*, 0.1 mM xanthine, enzyme preparation and xanthine oxidase. The reaction was started by the addition of 20  $\mu$ l xanthine oxidase. One unit of superoxide dismutase was defined as the amount which inhibited the reduction rate of cytochrome *c* by 50 % under the assay conditions mentioned above.

Protein was determined according to Lowry et al. (17).

#### *Chemicals*

Bovine erythrocyte superoxide dismutase, milk xanthine oxidase and heart cytochrome *c* were purchased from Sigma Chemical Co.

### Results

Fig. 1 shows the absorption spectra of 80 % acetone extracts obtained from the same area of fumigated and unfumigated leaves. The decrease of absorption occurred both in the red and the blue regions by SO<sub>2</sub> fumigation. However, a new peak and peak shift did not appear. The shoulder, around 455 nm corresponding to the soret band of chlorophyll *b*, became prominent suggesting that carotenoids are more labile than chlorophyll *b* on SO<sub>2</sub> fumigation.

Chromatographic separation revealed that the pigments were not destroyed within 2 hr, after this time chlorophyll *a* was rapidly broken down but chlorophyll *b* was not degraded over the 8 hr period (Fig. 2). The susceptibility of chlorophyll *a* to SO<sub>2</sub> was in good agreement with the earlier report by Müller (24). The content of pheophytin *a* was not changed and pheophytin *b* was not detected. Carotenoids were rapidly broken as well. When fumigation was prolonged over 8 hr-fumigation period, the rate of pigments breakdown slowed and chlorophyll *b* was gradually degraded (data not shown). A new spot of the visible component other than those mentioned above, were not detected on the thin-layer chromatogram.



When fumigation was performed in the dark, chlorotic symptoms did not appear at least for 10 hr. In darkness, the entry of the gas into leaves may be reduced because of stomatal closure. However, it was not clear whether light only stimulated the entry of

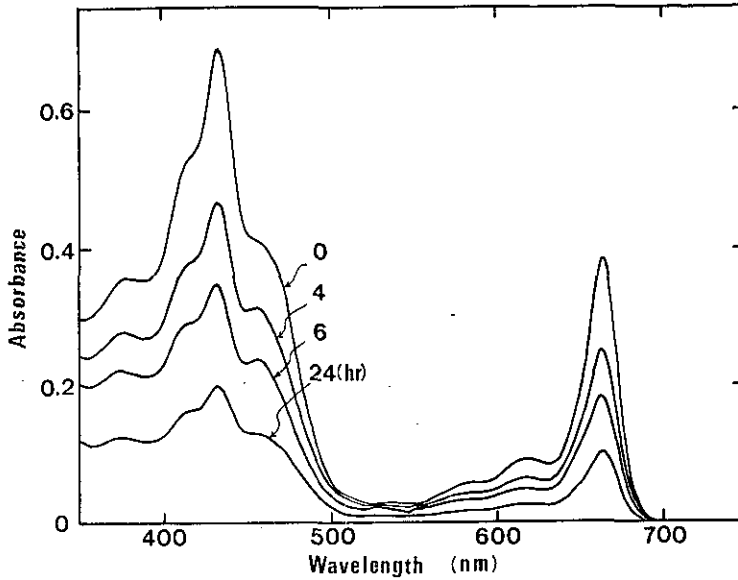

Fig. 1. Effect of  $SO_2$  fumigation on the absorption spectra of photosynthetic pigments in spinach leaves. The lengths of fumigation periods are indicated in the figure. Pigments were extracted with 80 % acetone from the same leaf area of  $SO_2$ -fumigated leaves.

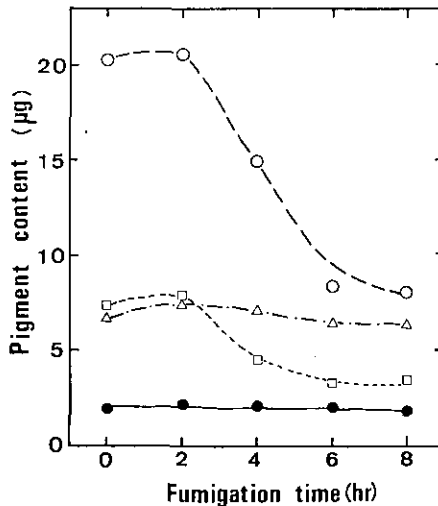

Fig. 2. Time courses of the destruction of photosynthetic pigments by  $SO_2$  fumigation. Contents of chlorophyll *a* (—○—), chlorophyll *b* (—△—), pheophytin *a* (—●—) and total carotenoids (—□—) in spinach leaves which were fumigated with  $SO_2$  for various periods. For details, see text.

SO<sub>2</sub> or it also caused the degradation of photosynthetic pigments with the aid of SO<sub>2</sub>. Thus, the effect of light on the destruction of photosynthetic pigments was examined using leaf disks ( $\phi=10$  mm) punched from spinach leaves fumigated with SO<sub>2</sub> at 2.0 ppm for 2 hr. During this time, no significant loss of chlorophyll was observed. Chlorophyll *a* was almost linearly destroyed for 5 hr in light but was not destroyed in darkness (Fig. 3). Carotenoids seem to be more rapidly destroyed than chlorophyll *a*. In unfumigated leaf disks, the pigments were not affected in light (data not shown).

The requirement of O<sub>2</sub> for the destruction of chlorophyll is shown in Fig. 4. When O<sub>2</sub> was removed by a stream of N<sub>2</sub>, chlorophyll destruction was suppressed, suggesting the participation of active oxygens in this event. Chlorophyll *a* destruction was inhibited by free radical scavengers, hydroquinone, tiron (22) and ascorbate (9) but singlet oxygen scavengers, DABCO (25), methionine and histidine (6) and hydroxyl radical scavengers, benzoate (6) and formate were essentially without effect (Table 1). Moreover, D<sub>2</sub>O, which lengthen the lifetime of <sup>1</sup>O<sub>2</sub> (21), did not stimulate the chlorophyll destruction. These results suggest that chlorophyll destruction by SO<sub>2</sub> fumigation was due to free radicals, probably superoxide radicals. If so, the chlorophyll destruction may be suppressed by superoxide dismutase (SOD) which catalyzes the dismutation of superoxide radicals to hydrogen peroxide and oxygen (20). The effect of SOD on chlorophyll destruction was examined by adding the enzyme to the homogenate of fumigated leaves. SOD strongly suppressed the chlorophyll destruction, though the inhibitory effect of this enzyme was not complete. A control protein, bovine serum albumin (BSA) had no inhibitory effect on the destruction of chlorophyll *a* (Fig. 5). In

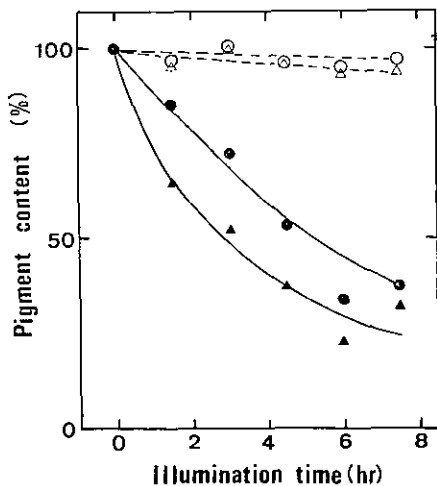

Fig. 3. Light requirement for the destruction of the photosynthetic pigments in SO<sub>2</sub>-fumigated leaves of spinach. Chlorophyll *a* in darkness (—○—) and in light (—●—). Total carotenoids in darkness (—△—) and in light (—▲—). Chlorophylls and carotenoids were determined by the methods of Mackinney (18) and Kirk and Allen (14), respectively.

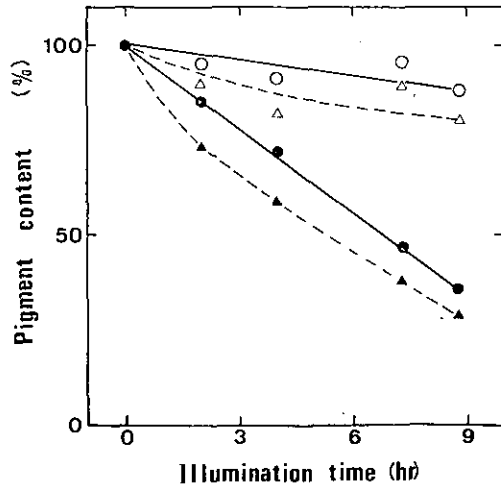

Fig. 4. Oxygen requirement for the destruction of photosynthetic pigments in SO<sub>2</sub>-fumigated leaves. Chlorophyll *a* in N<sub>2</sub> gas (—○—) and in air (—●—). Total carotenoids in N<sub>2</sub> gas (—△—) and in air (—▲—). See footnotes in Fig. 3.

unfumigated sample, chlorophyll *a* was destroyed by less than 5% of original values during 2 hr illumination, however, SOD and BSA had no inhibitory effect on the chlorophyll *a* destruction (data not shown).

Fig. 6 shows the effect of SO<sub>2</sub> fumigation on the activity of endogenous SOD, a

Table 1 *Effects of tiron, ascorbate, hydroquinone, DABCO, methionine, D<sub>2</sub>O, benzoate and formate on the destruction of chlorophyll a in SO<sub>2</sub>-fumigated leaves of spinach*

Additions	Chlorophyll <i>a</i> destroyed (%)	
	Illumination time (hr)	
	3	6
None	100	100
Tiron, 1 mM	27	84
10 mM	2	29
Ascorbate, 1 mM	73	56
10 mM	27	16
Hydroquinone, 0.1 mM	0	39
1 mM	-12	10
DABCO, 10 mM	77	105
Methionine, 10 mM	116	97
Histidine, 10 mM	114	87
D <sub>2</sub> O	70	112
Benzoate, 10 mM	107	148
Formate, 10 mM	117	150

SO<sub>2</sub> fumigation was performed for 2 hr at 2.0 ppm. The chlorophyll *a* destruction in the reference samples (None) were about 30% of total chlorophyll *a* for 3 hr-illumination and 60% of it for 6 hr-illumination, respectively. The reagents were added to the leaf disks under vacuum infiltration.

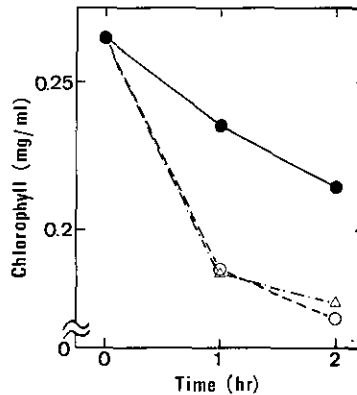

Fig. 5. *Effect of SOD on chlorophyll a destruction in the homogenate obtained from SO<sub>2</sub>-fumigated leaves of spinach.* Chlorophyll *a* in the presence of SOD (—●—) and BSA (—▲—). No addition (—○—). Spinach leaves fumigated with SO<sub>2</sub> for 3 hr, were homogenized in distilled water with Polytron (Kinematica PT 10/35). The homogenate was filtered through four layers of gauze and the resultant filtrates were used for the experiments. The filtrates (0.265 mg chl/ml) in Petri dishes were illuminated with white light at the light intensity of 30,000 lux. Superoxide dismutase and bovine serum albumin (BSA) were added to the leaf homogenate at 1 mg/ml.

## Chlorophyll destruction in SO<sub>2</sub>-fumigated leaves

major scavenger of O<sub>2</sub><sup>-</sup> in spinach leaves. SOD activity was reduced by 60 % during SO<sub>2</sub> fumigation for 2 hr without producing any chlorophyll destruction. SOD activity was further reduced when chlorophyll destruction was proceeded. However, SO<sub>2</sub> fumigation for 2 hr decreased the protein content by 10 % indicating the reduction of specific activity of SOD. From these results and above observations we conclude that chlorophyll *a* was destroyed by O<sub>2</sub><sup>-</sup> in SO<sub>2</sub>-fumigated leaves of spinach.

The malondialdehyde (MDA), an indicator of lipid peroxidation (12), was formed in

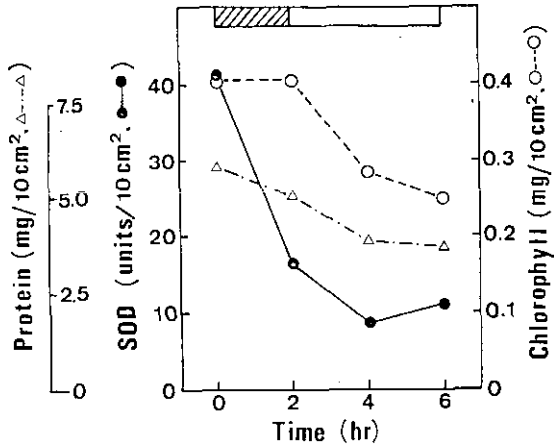

Fig. 6. Effect of SO<sub>2</sub> fumigation on the SOD activity and contents of chlorophyll *a* and protein. SO<sub>2</sub> fumigation (hatched bar) was performed for 2 hr. After fumigation, leaf disks were excised and were illuminated as described above.

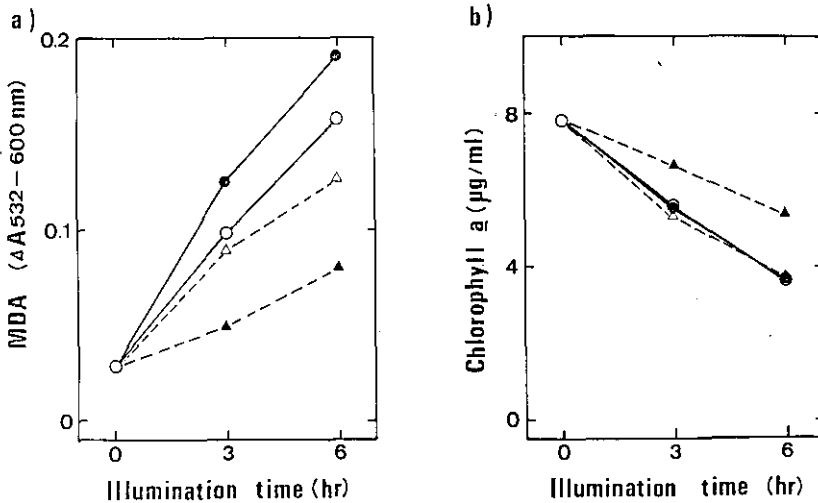

Fig. 7a. Effect of D<sub>2</sub>O (●-●), DABCO (Δ-Δ) and tiron (▲-▲) on the MDA formation in SO<sub>2</sub>-fumigated leaves of spinach. No addition (○-○).

Fig. 7b. Effect of D<sub>2</sub>O (●-●), DABCO (Δ-Δ) and tiron (▲-▲) on the chlorophyll destruction in SO<sub>2</sub>-fumigated leaves of spinach. No addition (○-○).

parallel with the chlorophyll *a* destruction (Fig. 7). DABCO effectively inhibited the MDA formation. MDA formation was increased by D<sub>2</sub>O. However, benzoate and formate had no significant effect on MDA formation (not shown). Thus singlet oxygen may play a dominant role in lipid peroxidation of SO<sub>2</sub>-fumigated leaves. All these reagents such as DABCO, D<sub>2</sub>O, benzoate and formate were without effect on the breakdown of chlorophyll *a* (Fig. 7).

### Discussion

The destruction of photosynthetic pigments by SO<sub>2</sub> required both light and oxygen. The effects of scavengers and enzyme on chlorophyll destruction showed that the event was due to superoxide radicals.

Chloroplasts produce O<sub>2</sub><sup>-</sup> under illumination, however most of the O<sub>2</sub><sup>-</sup> formed in chloroplasts is scavenged by SOD. According to the estimate of Asada et al. (4), SOD dismutates the O<sub>2</sub><sup>-</sup> and decreases the steady state concentrations of O<sub>2</sub><sup>-</sup> to about 0.1 %. If SOD was inactivated by SO<sub>2</sub> fumigation, the concentration of O<sub>2</sub><sup>-</sup> would increase greatly in chloroplasts. In fact, SO<sub>2</sub> fumigation affected the activity of SOD significantly. It seems reasonable to assume that the production of O<sub>2</sub><sup>-</sup> increased due to loss of the scavenging ability of O<sub>2</sub><sup>-</sup> by SO<sub>2</sub> fumigation. In addition, O<sub>2</sub><sup>-</sup> production could be amplified via aerobic oxidation of sulfite in a chain reaction as indicated by Asada et al. (4).

On the other hand, sulfite is highly reactive with disulfide bond in proteins. Sulfitolysis of the disulfide bond may cause the unfolding of the proteins because of the key role of the disulfide bridge in the conformational structure of protein molecules. A recent study by Miszalski and Ziegler (23) indicated that SO<sub>2</sub> fumigation elevated the thiol groups in the thylakoid and the elevation was greater under illumination than in darkness. Chlorophyll bound with protein is relatively stable to light and oxygen, while chlorophyll in free form in an organic solvent is extremely labile to active oxygens (26, 27). It cannot be excluded, therefore, that sulfite exerts a detriolating effect on proteins which stabilizes the chlorophyll.

Recently, in a 65 % ethanol solution *in vitro*, Peiser and Yang (27) demonstrated that chlorophyll was destroyed by free radicals produced during the homolytic cleavage of linoleic acid hydroperoxide by bisulfite. More recently, they (28) showed that a greater production of MDA occurred in leaves which were highly damaged following SO<sub>2</sub> fumigation. On the basis of these results obtained from *in vitro* and *in vivo* experiments, they suggested that the lipid hydroperoxide formation was essential to the destruction of chlorophyll (28). In our present investigation, lipid peroxidation, parallel to the chlorophyll *a* destruction, was also shown in SO<sub>2</sub>-fumigated leaves which were visibly damaged in light. However, neither DABCO, which inhibited the lipid peroxidation, nor D<sub>2</sub>O, which stimulated the lipid peroxidation, had any effect on the chlorophyll *a* destruction. The results cast some doubt on the essential role of lipid hydroperoxide in chlorophyll destruction as suggested by Peiser and Yang (28). Further investigation is necessary to clarify this point.

MDA formation was increased with increasing the destruction of chlorophyll *a*. MDA formation was decreased with decreasing chlorophyll *a* destruction through the addition of tiron to the leaf disks (Fig. 7). The parallelism in chlorophyll destruction and MDA formation (Fig. 7) suggests that there is an interrelationship between formation of O<sub>2</sub><sup>-</sup> and <sup>1</sup>O<sub>2</sub> assuming these effects result from the production of O<sub>2</sub><sup>-</sup> and <sup>1</sup>O<sub>2</sub>.

## Chlorophyll destruction in SO<sub>2</sub>-fumigated leaves

respectively. A scavenger of O<sub>2</sub><sup>-</sup>, tiron at 50 mM, which does not directly react with <sup>1</sup>O<sub>2</sub>, suppressed completely the formation of <sup>1</sup>O<sub>2</sub> as measured by MDA formation. This indicates that the production of <sup>1</sup>O<sub>2</sub> was mediated through O<sub>2</sub><sup>-</sup> as demonstrated by several workers (8, 13, 34, 35).

As described above, O<sub>2</sub><sup>-</sup> which was formed in SO<sub>2</sub>-fumigated leaf cells, not only destroyed the chlorophyll but also produced <sup>1</sup>O<sub>2</sub> which was responsible for the lipid peroxidation. Thus, the superoxide anion plays a central role in expressing the visible damage of SO<sub>2</sub>. Asada et al. (3) and Epel and Neumann (9) demonstrated that the O<sub>2</sub><sup>-</sup> was formed by univalent reduction of molecular oxygen with a reduced primary electron acceptor of photosystem I in illuminated chloroplasts. Photoreduction of O<sub>2</sub> *in vivo* by a reductant in photosystem I was also shown by Radmer and Kok (30) using green and blue-green algae. As shown in Table 2 phenazine methosulfate (PMS) at 0.1 mM diminished the chlorophyll breakdown by 50 % of the control. PMS, a mediator of cyclic electron flow, may compete with O<sub>2</sub> for accepting electrons from the reducing side of photosystem I and might thereby decrease the rate of O<sub>2</sub><sup>-</sup> formation. MV increased the chlorophyll destruction 2 to 3-fold. MV is reduced by the primary electron acceptor of system I and forms a very autoxidizable radical to produce O<sub>2</sub><sup>-</sup> by rapid reacting with O<sub>2</sub>. It is possible, therefore, that some part of O<sub>2</sub><sup>-</sup> was generated at the reducing side of photosystem I in SO<sub>2</sub>-fumigated leaves. We can note that SO<sub>2</sub> fumigation injured the photosystem II activity but the activity of photosystem I was highly resistant to SO<sub>2</sub> fumigation (33).

Table 2 *Effects of PMS and MV on the destruction of chlorophyll a in SO<sub>2</sub>-fumigated leaves of spinach*

Additions		Chlorophyll a content (%)				
		Illumination time (hr)				
		0	2	3	4	6
Exp. 1	None	100	78		54	
	PMS (0.1 mM)	100	87		77	
Exp. 2	None	100		78		49
	MV (1 mM)	100		41		16

SO<sub>2</sub> fumigation was performed for 2 hr at 2.0 ppm. The reagents were added to the leaf disks under vacuum infiltration.

We wish to thank Dr. N. Kondo, National Institute for Environmental Studies, for his valuable discussion and suggestion in the course of this work.

### References

1. Asada, K. and S. Kanematsu: Reactivity of thiols with superoxide radicals. *Agr. Biol. Chem.* 40: 1891-1892 (1976).
2. Asada, K. and K. Kiso: Initiation of aerobic oxidation of sulfite by illuminated spinach chloroplasts. *Eur. J. Biochem.* 33: 253-257 (1973).
3. Asada, K., K. Kiso and K. Yoshikawa: Univalent reduction of molecular oxygen by spinach chloroplasts on illumination. *J. Biol. Chem.* 249: 2175-2181 (1974).
4. Asada, K., M. Takahashi, K. Tanaka and Y. Nakano: Formation of active oxygen and its fate in chloroplasts. In *Biochemical and Medical aspects of Active oxygen*. Edited by O. Hayaishi and K.

- Asada, p.45-63. University of Tokyo Press, Tokyo, 1977.
5. Bailey, J. L. and R. D. Cole: Studies on the reaction of sulfite with proteins. *J. Biol. Chem.* 234: 1733-1739 (1959).
  6. Bodaness, R. S. and P. C. Chan: Singlet oxygen as a mediator in the hematoporphyrin catalized photooxidation of NADPH to NADP<sup>+</sup> in deuterium oxide. *J. Biol. Chem.* 253: 8554-8560 (1977).
  7. Bray, R.C., S. A. Cockle, E. M. Fielden, P.B. Roberts, G. Rotilio and L. Calabrese: Reduction and inactivation of superoxide dismutase by hydrogen peroxide. *Biochem. J.* 139: 43-48 (1974).
  8. Elstner, E. F. and J. R. Konze: Light-dependent ethylene production by isolated chloroplasts. *FEBS Lett.* 45: 18-21 (1974).
  9. EpeI, B. L. and J. Neumann: The mechanism of the oxidation of ascorbate and Mn<sup>++</sup> by chloroplasts. The role of radical superoxide. *Biochim. Biophys. Acta* 325: 520-529 (1973).
  10. Forti, G. and P. Gerola: Inhibition of photosynthesis by azide and cyanide and the role of oxygen in photosynthesis, *Plant Physiol.* 59: 859-862 (1977).
  11. French, C. S.: The chlorophyll *in vivo* and *in vitro*. In *Encyclopedia of Plant Physiology*. Edited by W. Ruhland p.251-297. Springer-Verlag, Berlin, 1960.
  12. Heath, R. L. and L. Packer: Photoperoxidation in isolated chloroplasts I. Kinetics and stoichiometry of fatty acid peroxidation. *Arch. Biochem. Biophys.* 125: 189-198 (1968).
  13. Kellogg, E. W. and I. Fridovich: Liposome oxidation and erythrocyte lysis by enzymatically generated superoxide and hydrogen peroxide. *J. Biol. Chem.* 252: 6721-6728 (1977).
  14. Kirk, J. T. O. and R. L. Allen: Dependence of chloroplast pigment synthesis on protein synthesis: effect of actidione. *Biochem. Biophys. Res. Commun.* 21: 523-530 (1965).
  15. Kondo, N. and K. Sugahara: Changes in transpiration rate of SO<sub>2</sub>-resistant and -sensitive plants with SO<sub>2</sub> fumigation and the participation of abscisic acid. *Plant & Cell Physiol.* 19: 365-373 (1978).
  16. Liaaen-Jensen, S. and A. Jensen: Quantitative determination of carotenoids in photosynthetic tissues. In *Methods in Enzymology 23; A*. Edited by A. San Pietro p.586-6002. Academic Press, New York, 1971.
  17. Lowry, O. H., N. J. Rosenbrough, A. L. Farr and R. J. Randall: Protein measurement with the Folin phenol reagent. *J. Biol. Chem.* 193: 265-275 (1951).
  18. Mackinney, G.: Absorption of light by chlorophyll solutions. *J. Biol. Chem.* 140: 315-322 (1941).
  19. Malhotra, S. S.: Effects of aqueous sulphur dioxide on chlorophyll destruction in *Pinus contorta*. *New Phytol.* 78: 101-109 (1977).
  20. McCord, J. M. and I. Fridovich: Superoxide dismutase An enzymic function for erythrocuprein (hemocuprein). *J. Biol. Chem.* 244: 6049-6055 (1969).
  21. Merkel, P. B., R. Nilsson and D. R. Kearns: Deuterium effects on singlet oxygen lifetime in solutions. *J. Amer. Chem. Soc.* 94: 1030-1031 (1973).
  22. Miller, R. W. and F. D. H. Macdowall: The tiron free radical as a sensitive indicator of chloroplastic photooxidation. *Biochim. Biophys. Acta* 387: 176-187 (1975).
  23. Miszalski, Z. and I. Ziegler: Increase in chloroplastic thiol groups by SO<sub>2</sub> and its effect on light modulation of NADP-dependent glyceraldehyde 3-phosphate dehydrogenase. *Planta* 145: 383-387 (1979).
  24. Müller, J.: Spezifischer nachweis von SO<sub>2</sub>-Rauchschaden an Pflanzen mit Hilfe von Blattpigmentanalysen. *Naturwissenschaften* 44: 453 (1957).
  25. Ouannes, C. and T. Wilson: Quenching of singlet oxygen by tertiary aliphatic amines. Effect of DABCO. *J. Amer. Chem. Soc.* 90: 6527-6528 (1968).
  26. Peiser, G. D. and S. F. Yang: Chlorophyll destruction by the bisulfite-oxygen system. *Plant Physiol.* 60: 277-281 (1977).
  27. Peiser, G. D. and S. F. Yang: Chlorophyll destruction in the presence of bisulfite and linoleic acid hydroperoxide. *Phytochemistry* 17: 79-84 (1978).
  28. Peiser, G. D. and S. F. Yang: Ethylene and ethane production from sulfur dioxide-injured plants. *Plant Physiol.* 63: 142-145 (1979).
  29. Puckett, K. J., E. Nieboer, W. P. Flora and D. H. S. Richardson. Sulphur dioxide: its effect on photosynthetic <sup>14</sup>C fixation in lichens and suggested mechanisms of phytotoxicity. *New Phytol.* 72: 141-154 (1973).
  30. Radmer, R. J. and B. Kok: Photoreduction of O<sub>2</sub> primes and replaces CO<sub>2</sub> assimilation. *Plant*

Chlorophyll destruction in SO<sub>2</sub>-fumigated leaves

- Physiol.* 58: 336-340 (1976).
31. Rao, D. N. and F. Leblanc. Effects of sulfur dioxide on the lichen algae with special reference to chlorophyll. *Bryologist* 69: 69-73 (1965).
  32. Setterstrom, C. and P. W. Zimmerman: Factors influencing susceptibility of plants to sulphur dioxide I. *Contrib. Boyce Thomson Inst.* 10: 155-181 (1939).
  33. Shimazaki, K. and K. Sugahara: Specific inhibition of photosystem II activity in chloroplasts by fumigation of spinach leaves with SO<sub>2</sub>. *Plant & Cell Physiol.* 20: 947-955 (1979).
  34. Takahama, U. and M. Nishimura: Effects of electron donor and acceptors, electron transfer mediators, and superoxide dismutase on lipid peroxidation in illuminated chloroplast fragments. *ibid.* 17: 111-118 (1976).
  35. Takahama, U. and M. Nishimura: Formation of singlet oxygen in illuminated chloroplasts. Effects on photoinactivation and lipid peroxidation. *ibid.* 16: 737-748 (1975).
  36. Taylor, O. C.: Acute responses to aerial pollutants. In *Air Pollution Damage to Vegetation*. Edited by J. A. Naegele. p.9-20. Academic Chemical Society, Washington D. C., 1973.
  37. Thomas, M. D. and G. R. Hill: Absorption of sulphur dioxide by alfalfa and its relation to leaf injury. *Plant Physiol.* 10: 291-307 (1935).
  38. Ziegler, I.: Subcellular distribution of <sup>35</sup>S sulfur in spinach leaves after application of <sup>35</sup>SO<sub>4</sub><sup>2-</sup>, <sup>35</sup>SO<sub>3</sub><sup>2-</sup>, and <sup>35</sup>SO<sub>2</sub>. *Planta* 135: 25-32 (1977).



## Effects of sulfite ions on water-soluble chlorophyll proteins

Kiyoshi Sugahara<sup>1</sup>, Setsuko Uchida<sup>2</sup> and Michiaki Takimoto<sup>2</sup>

<sup>1</sup> Division of Environmental Biology, The National Institute for Environmental Studies,  
Yatabe, Ibaraki 305

<sup>2</sup> Department of Environmental Chemistry, Faculty of Science, Toho University,  
Funabashi, Chiba 274

To clarify the mechanisms and processes of chlorophyll destruction and the relation to the appearance of visible symptoms in SO<sub>2</sub>-injured plants, model experiments were carried out by utilizing the peculiar properties of a water-soluble chlorophyll protein from *Chenopodium album*.

The acceleration of chlorophyll destruction by sulfite ions under aerobic and illuminated conditions, reported previously in organic solvent, was not observed for the water-soluble pigment-protein complex, even in  $4 \times 10^{-2}$  M sulfite. This indicates that pigments are stabilized by combining with protein molecules.

On the comparison of pigment destruction between the reconstituted chlorophyll *a*- and chlorophyllide *a*-proteins in the presence of sulfite ions, the former was slightly sensitive to sulfite ions. On the other hand, it was demonstrated that photoconversion of water-soluble chlorophyll protein was inhibited by denaturation of the protein moiety caused by sulfite ions in the presence of light. In addition it was shown that it was necessary for the pigment absorbing the light energy to be structurally related to the protein moiety for inhibition of photoconversion.

From these results, the inhibition processes of photoconversion are inferred as follows: conformational changes of apoprotein molecules were induced by light energy absorbed by the pigments and which allowed sulfite ions to attack the apoprotein molecules. The mechanism of the sulfite action on the apoprotein is the breakdown of disulfide bonds in proteins, the disulfide bonds having important functions in the photoconversion process.

From the present model experiments, it is suggested that the breakdown of disulfide bonds occurred and induced damage to the chloroplast lamellae or physiological functions in the SO<sub>2</sub>-injured plant tissues.

**Key words:** Air pollution – Breakdown of disulfide bond – Chlorophyll destruction  
– Sulfite ions – Sulfur dioxide – Water-soluble chlorophyll protein

Sulfite is generally accepted to be the principle mode of SO<sub>2</sub> action on cell metabolism. After passing through the stomata, SO<sub>2</sub> dissolves in the cytoplasm and produces H<sup>+</sup>, HSO<sub>3</sub><sup>-</sup> and SO<sub>3</sub><sup>2-</sup>. These sulfite ions affect physiological functions such as photosynthetic electron transport (13, 14), photophosphorylation (1, 12) and CO<sub>2</sub> fixation (11, 17).

During SO<sub>2</sub> fumigation, visible symptoms appear on the leaf caused by chlorophyll destruction. Many studies have been performed to establish certain relationships between

the visible symptoms and SO<sub>2</sub> injury, but little has been done to elucidate the mechanism of chlorophyll destruction by SO<sub>2</sub>.

Recently, the mechanism of chlorophyll destruction by sulfite was investigated in detail in an organic solvent, 76% (v/v) ethanol (9). However, chlorophyll is associated with the thylakoid membrane of chloroplast and is connected with lipid and protein molecules *in vivo*. Therefore, it is unreasonable to consider that reactions for chlorophyll destruction in the organic solvent are the same as those in the thylakoid membrane in chloroplasts *in vivo*. It is desirable, therefore, to design a model *in vitro* system in which the state form of chlorophyll is more similar to that *in vivo*.

From this point of view, we selected a water-soluble chlorophyll protein isolated from the leaves of *Chenopodium album* (16). The reasons why we selected the material are as follows: 1) it is water-soluble and stable in aqueous media, 2) the dark form, prepared in darkness (CP668, main absorption peak 668 nm), is photoconvertible to the illuminated form (CP743, main absorption peak 743 nm), 3) the apoprotein, obtained by removing pigments from the chlorophyll protein with methyl ethyl ketone, can be reconstituted with chlorophyll *a*, pheophytin *a* and chlorophyllide *a* to form the respective photoconvertible and water-soluble chromoproteins.

Thus, we could investigate the effects of sulfite ions on pigment and protein moieties of the pigment-protein complex by using the water-soluble chlorophyll protein *in vitro*.

In the present study, chlorophyll *a*-protein and chlorophyllide *a*-protein were reconstituted from the apoprotein of the original CP668, in order to examine the possibility that the process of chlorophyll destruction by SO<sub>2</sub> may be *via* chlorophyllide (5). Moreover, for elucidating the action of SO<sub>2</sub> on the membrane protein, the effect of sulfite on the protein molecule was investigated by using the photoconvertibility of the material as an indicator of protein denaturation.

## Materials and methods

### *Plant materials*

Leaves of *Chenopodium album* were obtained in summer from the fields near the Institute and Toho University to prepare a water-soluble chlorophyll protein.

Spinach (*Spinacia oleracea* L.) plants were grown in a greenhouse of the phytotron and were used for isolation of chlorophyll.

The young leaves (sprouts) of tea (*Thea senensis* L. var. Sayamamidori) plants were harvested from the farm of Ibaraki Horticultural Training School for use in the extraction of chlorophyllase.

### *Spectrophotometric measurements*

Absorption spectra and photoconversion of a water-soluble chlorophyll protein were measured using a Cary 17DX spectrophotometer.

### *Purification of chlorophyll a*

Chlorophyll *a* was purified on a column of powdered sugar according to the method of Perkins and Roberts (10).

### *Extraction of chlorophyllase*

About 300 g of young leaves (sprouts) of tea plants was homogenized in an ice-cold 0.05 M phosphate buffer (pH 7.2) with a mixer. After the homogenate was filtered through several layers of gauze, the filtrate was dropped into a deep-frozen acetone (-15°C). The precipitate obtained was collected on a Buchner funnel, dried in a

## Sulfite action on water-soluble chlorophyll protein

desiccator and stored at 0°C. 1 g of dried precipitate was suspended in 10 ml of 0.05 M phosphate buffer (pH 7.2), stirred for 1 hr and centrifuged at 15,000 × g for 15 min. The supernatant was used as the enzyme extract.

### *Preparation of chlorophyllide a*

Purified chlorophyll *a* was converted into chlorophyllide *a* by chlorophyllase in a reaction mixture containing 0.01 M phosphate buffer (pH 7.2), 50% of acetone, chlorophyll *a* and the enzyme extract, at 30°C for 10 min. At the end of the reaction time, acetone was added to the reaction mixture, giving a final concentration of 70%, to stop the enzyme reaction. To the mixture, an equal volume of *n*-hexane was added, shaken and centrifuged at 1,000 × g for 15 min. By this treatment, any chlorophyll *a* that still remained was transferred to the *n*-hexane layer, while chlorophyllide *a* produced was present in the aqueous acetone layer. Chlorophyllide *a* was extracted from the aqueous acetone layer with ethyl ether, then the extract of ethyl ether was evaporated to dryness using a rotary evaporator. Residual chlorophyllide *a* was dissolved in ethanol for use. The chlorophyllide *a* product was confirmed by paper chromatography (2).

### *Isolation of a water-soluble chlorophyll protein*

A water-soluble chlorophyll protein was extracted from the leaves of *Chenopodium album*, isolated and purified on the basis of the method of Yakushiji et al. (15) by performing column chromatography using DEAE-cellulose, Amberlite CG 50 and Sephadex G-100, in that order.

### *Reconstitution of chlorophyll a- and chlorophyllide a-proteins*

The preparation of apoprotein from the water-soluble chlorophyll protein and the reconstitution of chlorophyll *a*- and chlorophyllide *a*-proteins were carried out in accordance with the procedure of Murata et al. (7).

### *Chlorophyll determination in the water-soluble chlorophyll protein*

From the purified water-soluble chlorophyll protein, chlorophyll was repeatedly extracted with four parts of methyl ethyl ketone until removal of chlorophyll was complete. After dehydration with anhydrous Na<sub>2</sub>SO<sub>4</sub>, the extract of methyl ethyl ketone containing chlorophyll was evaporated to dryness and then the residual chlorophyll was dissolved in 80% acetone. The chlorophyll concentration in the acetone solution was determined by the method of Mackinney (4).

## Results

### *Destruction of chlorophyll a and chlorophyllide a in organic solvent by sulfite*

Peiser and Yang (9) reported that the destruction of chlorophyll in 76% ethanol in the presence of sulfite required light and O<sub>2</sub> and the optimum pH was 4. Before we investigated the destruction of chlorophyll in the pigment-protein complex by sulfite, we repeated the above experiment.

Fig. 1 shows the changes in absorption spectra of chlorophyll *a* by illumination. Even in the absence of sulfite (Fig. 1A), a decrease of absorbance at 663 nm was observed for each illumination of 1 min. However, the presence of sulfite (Fig. 1B) caused a rapid decrease in absorbance, approximately 80% of total chlorophyll *a* being destroyed by the first illumination of 1 min. In the case of chlorophyllide *a*, essentially same result as chlorophyll *a* was obtained (Fig. 2).

It is confirmed from these experiments, therefore, that chlorophyll is destroyed by

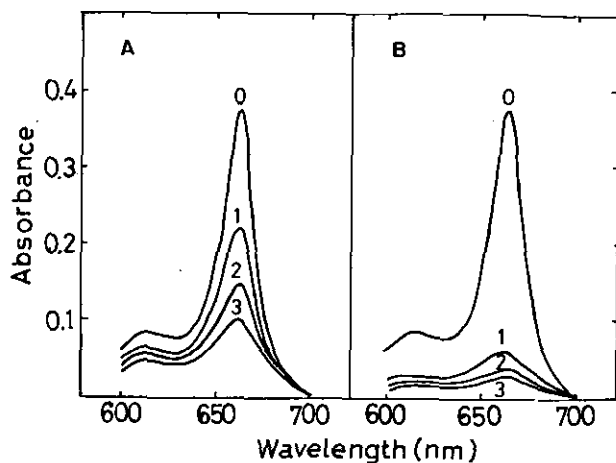

Fig. 1. Changes in absorption spectrum of chlorophyll *a* in organic solvent by illumination. Reaction mixture, in 4 ml, contained: glycine buffer (pH 4.1), 0.02M; NaHSO<sub>3</sub>, 2x10<sup>-3</sup>M; ethanol, 76%; chlorophyll *a*, equivalent to 0.3–0.4 of absorbance at 663 nm. The illumination was carried out using 300W of projector lamp at 50,000 lux for 1 min, repeatedly. (A) Control (–NaHSO<sub>3</sub>) (B) + NaHSO<sub>3</sub>. The number in figures shows total illumination times.

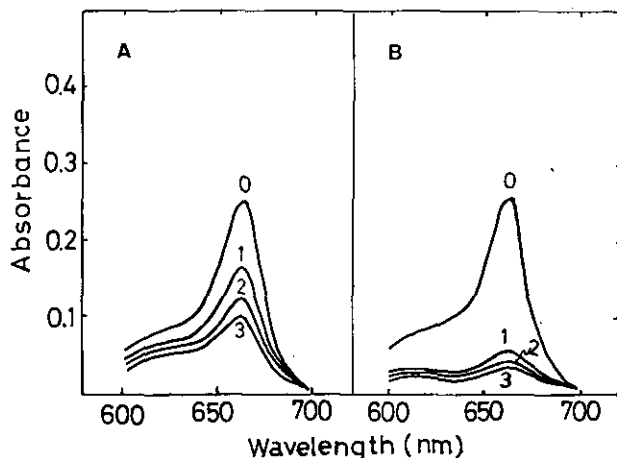

Fig. 2. Changes in absorption spectrum of chlorophyllide *a* in organic solvent by illumination. Reaction conditions are the same as in Fig. 1 except that chlorophyllide *a* was added to the reaction mixture instead of chlorophyll *a*. (A) Control (–NaHSO<sub>3</sub>) (B) + NaHSO<sub>3</sub>.

sulfite in the organic solvent in the presence of O<sub>2</sub> and light as previously reported (9).

*Effect of sulfite on chlorophyll in water-soluble chlorophyll protein*

A water-soluble chlorophyll protein of *Chenopodium album* contains chlorophyll *a*

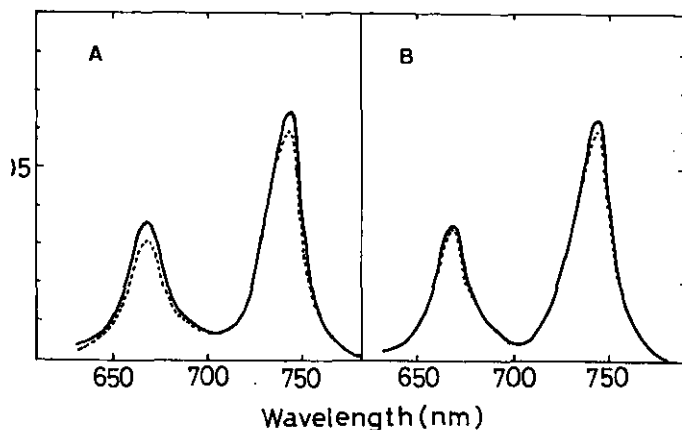

Fig. 3. Changes in absorption spectrum of reconstituted chlorophyll *a*-protein in aqueous medium by illumination. Reaction mixture, in 4 ml, contained: glycine buffer (pH 4.1), 0.07M;  $\text{NaHSO}_3$ ,  $4 \times 10^{-2}$ M; illuminated form of chlorophyll *a*-protein, equivalent to 0.05–0.1 of absorbance at 743 nm. The illumination was the same as in Fig. 1. (A) Control ( $-\text{NaHSO}_3$ ) (B)  $+\text{NaHSO}_3$ . —, illuminated form of chlorophyll *a*-protein; ---, after 3 min illumination.

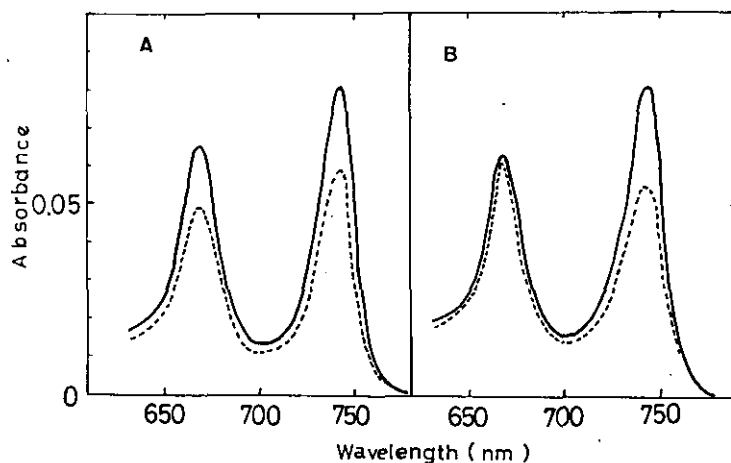

Fig. 4. Changes in absorption spectrum of reconstituted chlorophyllide *a*-protein in aqueous medium by illumination. Reaction conditions are the same as in Fig. 3 except that chlorophyllide *a*-protein was used instead of chlorophyll *a*-protein. (A) Control ( $-\text{NaHSO}_3$ ) (B)  $+\text{NaHSO}_3$ .

and chlorophyll *b* and the ratio of *a* to *b* is about 6 (16). In order to strictly compare, however, the effect of sulfite on chlorophyll *a* and chlorophyllide *a* in the organic solvent with that in the pigment-protein complex in aqueous media, chlorophyll *a*- and chlorophyllide *a*-proteins were reconstituted from the apoprotein of the dark form

(CP668) with purified chlorophyll *a* and chlorophyllide *a*. After photoconversion of these proteins by illumination for 1 min, changes in the absorption spectra of the illuminated form were measured in the presence of sulfite with each illumination for 1 min.

Fig. 3 shows the changes in absorption spectra of chlorophyll *a*-protein after the third illumination of 1 min. No appreciable decrease of absorbance was observed at 668 nm and 743 nm both in the absence and presence of sulfite. For the chlorophyllide *a*-protein, as seen in Fig. 4, a considerable decrease in absorbance was observed for both peaks in the absence of sulfite, while, in the presence of sulfite only the peak at 743 nm decreased. The large absorbance decrease by sulfite, demonstrated in the 76% ethanol system, was not shown, however, for this experiment between in the absence and presence of sulfite. In any case, chlorophyll *a* and chlorophyllide *a* were resistant to sulfite when in the pigment-protein complex in aqueous media, even if the sulfite concentration was  $4 \times 10^{-2}$  M (cf.  $2 \times 10^{-3}$  M in the organic solvent).

#### *Inhibition of photoconversion in chlorophyll protein by sulfite*

The experiments mentioned above were performed with the illuminated form of chlorophyll protein after photoconversion. Next, with the dark form of chlorophyll protein, the effect of sulfite was investigated by adding sulfite to CP668 in the dark before illumination. As seen in Fig. 5, when CP668 was illuminated in the presence of sulfite, photoconversion of CP668 to CP743 was blocked in both chlorophyll *a*- and chlorophyllide *a*-proteins. Moreover, extended illumination of the CP668 did not decrease the absorbance of chlorophyll significantly. From this result, it is inferred that sulfite preferentially attacks the protein moiety of the pigment-protein complex.

#### *Relationship between the concentrations of sulfite and chlorophyll protein in the inhibition of photoconversion*

Fig. 6 illustrates the effect of sulfite concentration on the photoconversion of chlorophyll *a*- and chlorophyllide *a*-proteins. Photoconversion of chlorophyll *a*-protein began to be inhibited with  $3 \times 10^{-4}$  M sulfite and inhibition was complete at  $6 \times 10^{-2}$  M

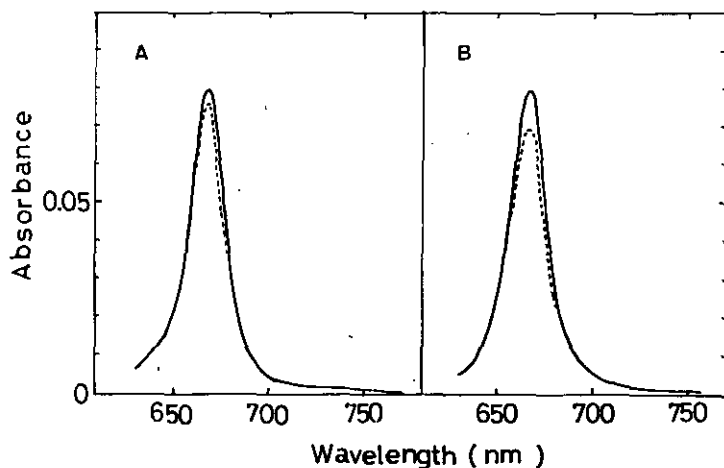

Fig. 5. *Inhibition of photoconversion in chlorophyll protein by sulfite* (A) Chlorophyll *a*-protein. (B) Chlorophyllide *a*-protein. Reaction mixtures are the same as in Fig. 3. —, before illumination dark form); - - -, after 2 min illumination.

Sulfite action on water-soluble chlorophyll protein

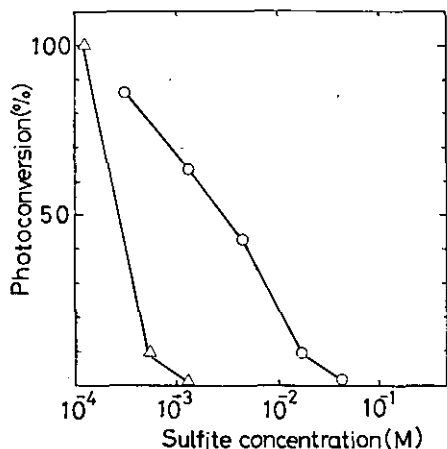

Fig. 6. Effect of sulfite concentration on photoconversion of reconstituted chlorophyll proteins. Reaction was carried out in 0.05M phosphate buffer, pH 7.2. —○—, chlorophyll *a*-protein (0.18 mg chlorophyll/1) —△—, chlorophyllide *a*-protein (0.57 mg chlorophyllide/1)

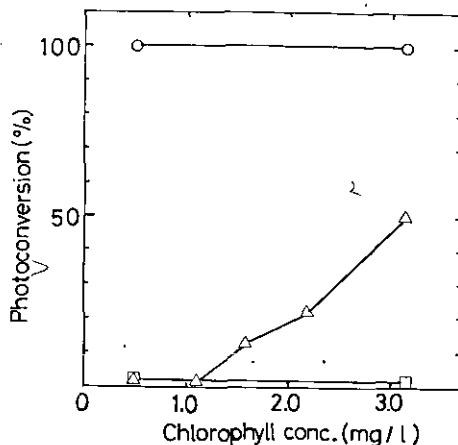

Fig. 7. Relationship between concentrations of sulfite and original chlorophyll protein in inhibition of its photoconversion. Reaction was carried out in 0.05M phosphate buffer, pH 7.2. Sulfite concentration: —○—,  $7.1 \times 10^{-3}$  M: —△—,  $1.4 \times 10^{-2}$  M: —□—,  $7.1 \times 10^{-2}$  M.

sulfite. On the other hand, chlorophyllide *a*-protein was more sensitive than chlorophyll *a*-protein and its photoconversion was inhibited completely above  $10^{-3}$  M of sulfite even though the pigment concentration of chlorophyllide *a*-protein was higher than that of chlorophyll *a*-protein. For the original chlorophyll protein, inhibition of photoconversion started at about  $10^{-3}$  M sulfite and was complete at  $10^{-2}$  M sulfite.

For three sulfite concentrations, the effect of chlorophyll protein concentration on photoconvertibility was investigated using the original chlorophyll protein (Fig. 7). At low concentrations of sulfite ( $7.14 \times 10^{-3}$  M) inhibition of photoconversion did not occur, while at high concentrations of sulfite ( $7.14 \times 10^{-2}$  M) complete inhibition was observed in the range 0.5 to 3 mg of chlorophyll *a + b* per liter as the chlorophyll protein. At medium concentration of sulfite ( $1.4 \times 10^{-2}$  M), however, inhibition began to be reduced by increasing the concentration of the chlorophyll protein above 1 mg chlorophyll per liter.

From this result, we can infer that sulfite ion reacts with a certain group in the protein molecule, such as the disulfide group, by combining each other.

*Irreversibility of photoconversion by removing sulfite from the sulfite-inhibited system*

After complete inhibition of photoconversion by sulfite under illumination, sulfite was removed from the sulfite-inhibited system by dialyzing the system against a phosphate buffer or by precipitating the chlorophyll protein with ammonium sulfate and dissolving it in fresh medium. With illumination of the sulfite-free chlorophyll protein, photoconversion did not take place (data not shown). This fact indicates that the inhibition of photoconversion by sulfite is irreversible.

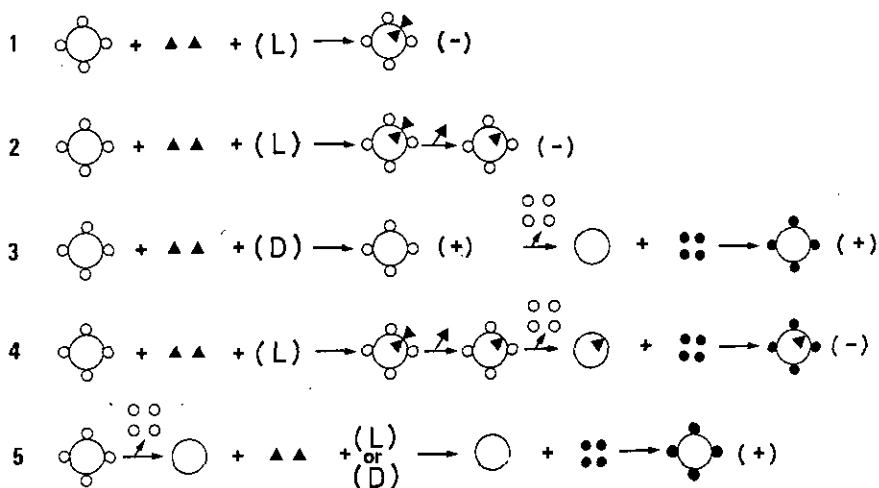

Fig. 8. Schematic diagram of effect of sulfite ion on photoconversion of water-soluble chlorophyll protein. O, apoprotein; O<sup>●</sup>, denatured apoprotein; ☉☉, chlorophyll a+b; ●●, chlorophyll a; ▲▲, sulfite ions; ↗, dialysis or ammonium sulfate fractionation; (L), illumination; (D), dark treatment; (+), active in photoconversion; (-), inactive in photoconversion.

*Light-dependent inhibition of photoconversion by sulfite*

After incubation of the original CP668 in 10<sup>-2</sup> M sulfite for 30 min in the dark, the concentration of which is sufficient to prevent photoconversion in the light, sulfite was eliminated from the CP668 solution by dialysis or fractionation of ammonium sulfate as described above. The CP668 treated with sulfite in the dark was normally photoconvertible by illumination. The same results were obtained for the reconstituted chlorophyll proteins and show that light is necessary to inhibit the photoconversion of chlorophyll protein in the presence of sulfite.

*Denaturation of the apoprotein in chlorophyll protein inhibited photoconversion by sulfite*

From the sulfite-inhibited CP668, the apoprotein was prepared and combined with chlorophyll a to reconstitute the pigment-protein complex. The absorption spectrum of this complex is the same as the original CP668, but photoconversion to CP743 by illumination did not occur.

*The effect of sulfite on the isolated apoprotein in the dark and in the light*

The apoprotein was isolated from the original CP668 and incubated in 10<sup>-2</sup> M sulfite for 10 min in the dark or in the light. After removing sulfite by dialysis or fractionation with ammonium sulfate, apoprotein was combined with chlorophyll a. Both the reconstituted chlorophyll a-proteins from the dark-treated and light-treated apoproteins were photosensitive giving rise to a new absorption peak at 743 nm after illumination. Since there is a possibility that the apoprotein does not absorb visible light, the illumination with ultraviolet light (254 nm of main wavelength, from ultraviolet lamp) was also performed on the apoprotein. However, the reconstituted chlorophyll



$\alpha$ -protein from the UV-illuminated apoprotein was also photosensitive to form CP743.

The results indicate that the pigment absorbing the light energy must be connected with the protein moiety in order for changes to take place in the apoprotein causing inhibition of photoconversion by sulfite and light.

### Discussion

Using a water-soluble chlorophyll protein, the pigment-protein complex, the effect of sulfite ions on chlorophyll destruction was investigated in aqueous media. Rapid destruction of the chlorophyll moiety by sulfite under illuminated and aerobic conditions was not observed in the pigment-protein complex. However, in the control experiment of free chlorophyll molecules in the organic solvent, the acceleration of chlorophyll destruction by sulfite was observed as previously reported (9). This result indicates that pigments were stabilized by combining with protein molecules.

Recently, Malhotra reported that aqueous  $\text{SO}_2$  activated chlorophyllase and the enzyme converted chlorophyll *b* to chlorophyllide *b* in pine needles (5). The possibility that chlorophylls are destroyed by sulfite *via* chlorophyllides was examined using reconstituted chlorophyll  $\alpha$ - and chlorophyllide  $\alpha$ -proteins by comparing their susceptibility to sulfite. Chlorophyllide  $\alpha$ -protein was only slightly sensitive compared to chlorophyll  $\alpha$ -protein. From this result, it is very difficult to discuss the possibility mentioned above.

Meanwhile, it has been demonstrated that photoconversion of CP668 to CP743 was inhibited by sulfite in the light. The inhibitory conditions were analyzed and are summarized schematically in Fig. 8. On the basis of the schematic diagram, light is necessary to inhibit the photoconversion in the presence of sulfite (see 1 and 3 in Fig. 8). In addition, photoconvertibility, once inhibited, could not be recovered by removing sulfite from the chlorophyll protein solution (see 2 in Fig. 8). Furthermore, the chlorophyll  $\alpha$ -protein obtained from reconstitution with the apoprotein from the sulfite-inhibited chlorophyll protein did not show photoconversion activity (see 4 in Fig. 8). While, the illumination of the apoprotein only from CP668 in the presence of sulfite did not affect the photoconvertibility when the chlorophyll  $\alpha$ -protein was reconstituted with this illuminated apoprotein and chlorophyll  $\alpha$  (see 5 in Fig. 8). This result indicates that the pigment is structurally related to the protein moiety.

From these results in Fig. 8, we can infer the following: the light energy absorbed by pigments was transferred to the apoprotein moiety and a conformational change in the apoprotein was induced in the chlorophyll protein molecule; the conformational change allowed sulfite to attack the apoprotein and sulfite combined with a certain group of the protein molecule.

The inhibitory mechanism of sulfite action on the apoprotein must be discussed. It has been reported that photoconversion of a water-soluble chlorophyll protein was inhibited by S-S reagents such as  $\beta$ -mercaptoethanol and dithiothreitol but not by SH reagents such as *p*-chloromercuribenzoic acid and N-ethylmaleimide (8). On the other hand, it is known that sulfite breaks down the disulfide bond in protein molecules as follows (6):

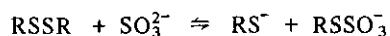

From these facts, we can infer that the particular group of the protein molecule

mentioned above is a disulfide bond and sulfite breaks down the disulfide bond in the apoprotein molecules.

In the inhibition of photoconversion, the effective range of the sulfite concentration was  $10^{-3} \sim 10^{-2}$  M as shown in Figs. 6 and 7. According to Kondo and Sugahara (3), this concentration is capable of occurring  $\text{SO}_2$ -fumigated leaves. Thus, from the present model experiments, it is suggested that in  $\text{SO}_2$ -injured plants the sulfite ions produced induce the destruction of chloroplast lamellae and inhibition of physiological functions by breakdown of disulfide bonds in the pigment-protein complexes. Finally, we have to keep in mind the important role of light in the inhibitory process.

#### References

1. Asada, K., R. Deura and Z. Kasai: Effect of sulfate ions on photophosphorylation by spinach chloroplasts. *Plant & Cell Physiol.* 9: 143-146 (1968).
2. Chiba, Y., I. Aiga, M. Idemori, Y. Satoh, K. Matsushita and T. Sasa: Studies on chlorophyllase of *Chlorella protothecoides* I. Enzymatic phytylation of methyl chlorophyllide. *Plant & Cell Physiol.* 8: 623-635 (1967).
3. Kondo, N. and K. Sugahara: Changes in transpiration rate of  $\text{SO}_2$ -resistant and -sensitive plants with  $\text{SO}_2$  fumigation and the participation of abscisic acid. *Plant & Cell Physiol.* 19: 365-373 (1978).
4. Mackinney, G.: Absorption of light by chlorophyll solutions. *J. Biol. Chem.* 140: 315-322 (1941).
5. Malhotra, S. S.: Effects of aqueous sulphur dioxide on chlorophyll destruction in *Pinus contorta*. *New Phytol.* 78: 101-109 (1977).
6. Mudd, J. B.: Sulfur dioxide. In *Responses of Plants to Air Pollution*. Edited by J. B. Mudd and T. T. Kozlowski. p. 9-22. Academic Press, New York, 1975.
7. Murata, T., Y. Okada, K. Uchino and E. Yakushiji: Reconstitution of the photo-sensitive form of *Chenopodium* chlorophyll protein from its apoprotein. In *Comparative Biochemistry and Biophysics of Photosynthesis*. Edited by K. Shibata, A. Takamiya, A. T. Jagendorf and R. C. Fuller. p. 222-228. Univ. Tokyo Press, Tokyo, 1967.
8. Oku, T. and G. Tomita: The reversible photoconversion of *Chenopodium* chlorophyll protein and its control by the apoprotein structure. *Plant & Cell Physiol.* 16: 1009-1016 (1975).
9. Peiser, G. D. and S. F. Yang: Chlorophyll destruction by the bisulfite-oxygen system. *Plant Physiol.* 60: 277-281 (1977).
10. Perkin H. J. and D. A. Roberts: Purification of chlorophylls, Pheophytins and pheophorbides for specific activity determinations. *Biochim. Biophys. Acta* 58: 486-498 (1962).
11. Puckett, K. J., E. Nieboer, W. P. Flora and D. H. S. Richardson: Sulfur dioxide: its effect on photosynthetic  $^{14}\text{C}$  fixation in lichens and suggested mechanisms of phytotoxicity. *New Phytol.* 72: 141-154 (1973).
12. Ryrie, I. J. and A. T. Jagendorf: Inhibition of photophosphorylation in spinach chloroplasts by inorganic sulfate. *J. Biol. Chem.* 246: 582-588 (1971).
13. Shimazaki, K. and K. Sugahara: Specific inhibition of photosystem II activity in chloroplasts by fumigation of spinach leaves with  $\text{SO}_2$ . *Plant & Cell Physiol.* 20: 947-955 (1979).
14. Silvius, J. E., M. Ingle and C. H. Baer: Sulfur dioxide inhibition of photosynthesis in isolated chloroplasts. *Plant Physiol.* 56: 434-437 (1975).
15. Takamiya, A.: Chlorophyll protein complexes. In *Method in Enzymol.* 23: 603-613 (1971).
16. Yakushiji, E., K. Uchino, Y. Sugimura, I. Shiratori and F. Takamiya: Isolation of water-soluble chlorophyll protein from the leaves of *Chenopodium album*. *Biochim. Biophys. Acta* 75: 293-297 (1963).
17. Ziegler, I.: The effect of  $\text{SO}_3^{2-}$  on the activity of ribulose-1,5-diphosphate carboxylase in isolated spinach chloroplasts. *Planta* 103: 155-163 (1972).

## Interspecific difference in resistance to sulfur dioxide

Akio Furukawa<sup>1</sup>, Osamu Isoda<sup>2</sup>, Hideo Iwaki<sup>2</sup> and Tsumugu Totsuka<sup>1</sup>

<sup>1</sup> Division of Environmental Biology, The National Institute for Environmental Studies, Yatabe, Ibaraki 305

<sup>2</sup> Graduate School of Environmental Science, The University of Tsukuba, Sakura-mura, Ibaraki 305

The relative resistance of plants to damage by SO<sub>2</sub> was investigated. Measurements were made of the rate of transpiration and foliar responses to SO<sub>2</sub>. In the present experiment, 29 plant species, including 25 herbaceous and 4 woody species were fumigated. Fumigation with 2.0 ppm SO<sub>2</sub> for 4 hr caused no visible injury on leaves of several plant species, while other species exhibited 100% leaf necrosis. The degree of foliar injury was examined in relation to i) leaf thickness (leaf aerial fresh weight) ii) transpiration rate, and iii) the amount of SO<sub>2</sub> absorbed to determine the main factor controlling interspecific responses to SO<sub>2</sub>. We obtained a highly significant correlation ( $r=0.78$ ) between the degree of foliar injury and the absorbed amount of SO<sub>2</sub>. We conclude that the interspecific differences in responses to SO<sub>2</sub> may be primarily determined by how plant species absorb SO<sub>2</sub>.

**Key words:** Plant resistance to SO<sub>2</sub> – SO<sub>2</sub> absorption of leaves – Transpiration rate – Visible injury of leaves

Sulfur dioxide is an important air pollutant. Industrialized nations largely depend on combustion of high sulfur containing fossil fuels for energy. The emissions of SO<sub>2</sub> to the atmosphere are increasing as world wide industrial activities increase. To date, numerous studies have been made on morphological and biochemical effects of SO<sub>2</sub> on plants. Reviews by Thomas (24, 25), Mudd (21), and Bell and Mudd (3) summarize these effects.

Acute exposure to SO<sub>2</sub> can cause necrosis on plant leaves. Plant species and cultivars differ in degree of injury which they sustain from the same level of acute exposure. The exposure of approximately 1.0 ppm SO<sub>2</sub> for 2–4 hr can cause foliar injury to many plants. In contrast, some species can tolerate several times this concentration with no visible symptoms. Several investigations have compiled tables of these differences in responses to SO<sub>2</sub> (2, 13); most notable, is the work carried out by O'Gara, cited by Thomas and Hendricks (26), who fumigated over 300 species and cultivars with SO<sub>2</sub> and graded resistance by a resistance factor relative to alfalfa. He found that duration of exposure time and SO<sub>2</sub> concentration required to produce foliar injury differed as much as 15-fold between species tested.

Mechanisms of SO<sub>2</sub> phytotoxicity and the mechanisms responsible for interspecific differences in resistance to SO<sub>2</sub> are poorly understood. However, two prerequisites for SO<sub>2</sub> injury could be considered. Interspecific or intraspecific (among cultivars)

differences in resistance to SO<sub>2</sub> could reflect the difference in stomatal resistance to entry of SO<sub>2</sub> or biochemical (enzymatic or non-enzymatic) detoxication of SO<sub>2</sub> incorporated into cells or both. Thomas and Hill (28), as early as 1935, showed that the extent of injury sustained by alfalfa plants subjected to varying amounts of light and humidity in the presence of SO<sub>2</sub> was correlated with the amount of SO<sub>2</sub> absorbed. From these results, Thomas speculated that species differences to SO<sub>2</sub> were mainly due to differences in the rate of SO<sub>2</sub> absorption (25). However, this hypothesis was not checked experimentally by Thomas. In 1978, Caput et al. (9) fumigated three species of *Pinus* and Bressan et al. (8) fumigated cultivars of *Cucurbita pepo* and *Cucumis sativus*, and they supported the suggestion of Thomas.

In the present study, we fumigated 29 plant species and undertook to look for factors which controll interspecific differences in responses to SO<sub>2</sub>. We also checked whether SO<sub>2</sub> induced the stomata of various plant species to open or close, which may affect the interspecific resistance to SO<sub>2</sub>.

## Materials and methods

### *Plant materials*

Species of plants tested are listed in Table 1. All species were grown in a phytotron greenhouse. Growing conditions and stages of development are also shown in Table 1. Herbaceous and tree species were grown in 10- and 25-cm plastic pots, respectively. The seedlings were thinned for uniformity after emergence to one plant per pot for all experiments. A day before use, plants were transferred to a controlled environment room (1.7 × 2.3 × 2.0 m high) with 16/8 hr of light/dark cycle, 25°C during the light and 20°C during the dark phase, 75% relative humidity (6 mmHg of water vapor saturation deficit at 25°C), and 30 klx at the level of the plants.

### *Fumigation system*

Plant fumigation was performed in a controlled environment room designed and constructed for studies of the effects of air pollutants on plants. The light source consisted of 24 400-W stannous halide lamps (Toshiba). The light was filtered through heat absorbing glass filter, which removed radiation above 800 nm. Fresh air was passed through charcoal and catalyst bearing (containing MnOx and CuO) filters to remove any ambient pollutants and led into the fumigation room. This filtration system proved effective for removal of SO<sub>2</sub>. The air velocity in the controlled environment room was 0.2–0.4 m·sec<sup>-1</sup>, and the ventilation rate was 30 times·hr<sup>-1</sup>. SO<sub>2</sub> from a compressed cylinder containing 4,000 ppm SO<sub>2</sub> in N<sub>2</sub> was injected through a thermal mass-flow controller into the gas stream. SO<sub>2</sub> concentration was regulated using a controlling system of a pulsed fluorescent SO<sub>2</sub> analyzer (Thermo Electron, Model 43). Recordings of SO<sub>2</sub> concentrations inside the room showed that on starting the fumigation the concentrations reached the fixed level within 5 min (Fig. 1). Concentrations of pollutants were regulated within ±5 ppm of the average values.

### *Transpiration measurements*

The transpiration rate was measured by the gravimetric method using electronic top-loading balances (Mettler, Model PE 11 and Model PT 15) and continuously recorded with a thermal data acquisition system (Eto Denki, Model Thermodac II) equipped with a personal computer (Canon, Model Canola SX-300 R).

The transpiration rate during SO<sub>2</sub> fumigation was expressed as a per cent of the rate

Interspecific difference in resistance to SO<sub>2</sub>Table 1 Plant materials used for the exposure to SO<sub>2</sub>.<sup>1</sup>

Plant No.	Common Name	Cultivar Name	Species Name	Culture Medium	Days after Sowing
1	sorghum		<i>Sorghum nitidum</i>		53
2	tomato	Fukuju-2	<i>Lycopersicon esculentum</i>		60
3	ginkgo		<i>Ginkgo biloba</i>		
4	corn	Yellow Dent Corn	<i>Zea mays</i>	*	39
5	soybean	Wase-Shiratori	<i>Glycine max</i>		43
6	cucumber		<i>Cucumis sativus</i>		31
7	poke weed		<i>Phytolacca americana</i>		45
8	cherry	Somei-Yoshino	<i>Prunus yedoensis</i>		
9	pimento	Ace	<i>Capsicum annuum</i>		62
10	rice	Nihonbare	<i>Oryza sativa</i>	**	62
11	egg plant		<i>Solanum melongena</i>		36
12	wheat	Norin-61	<i>Triticum aestivum</i>		36
13	swiss chard		<i>Beta vulgaris</i>		39
14	poplar		<i>Populus euramericana</i>		
15	kidney bean	Shin-Edogawa	<i>Phaseolus vulgaris</i>		36
16	peanut	Chiba-Handate	<i>Arachis hypogaea</i>		44
17		White Concine	<i>Brassica campestris</i>		43
18	spinach	New Asia	<i>Spinacia oleracea</i>		45
19	radish	Comet	<i>Raphanus sativus</i>		60
20	lettuce	White Paris	<i>Lactuca sativa</i>		45
21	beefsteak plant		<i>Perilla frutescens</i>		43
22	morning glory	Scarlet Ohara	<i>Pharbitis nil</i>		44
23	alfalfa	Common	<i>Medicago sativa</i>		69
24	broad bean	Otafuku	<i>Vicia faba</i>		44
25	castor oil plant		<i>Ricinus communis</i>		45
26	buckwheat		<i>Fagopyrum esculentum</i>		37
27	plane tree		<i>Platanus occidentalis</i>		
28	pea	Alaska	<i>Pisum sativum</i>		45
29	sunflower	Russian Mammoth	<i>Helianthus annuus</i>		21

1. Herbaceous species and poplar cuttings were grown from seeds or cuttings in a phytotron greenhouse at 25°C day and 20°C night and at 70% R.H.
2. \* NIES culture medium/sandy loam = 3/1 (v/v)  
\*\* grainy sandy loam  
others (NIES culture medium) = peatmoss/vermiculite/perlite/fine gravel = 2/2/1/1 (v/v)
3. Tree species except poplar were grown in a greenhouse for about 2 years and were transferred into a phytotron greenhouse about a week before the experiment.

prior to SO<sub>2</sub> treatment (pretreatment rate). The experimental conditions for SO<sub>2</sub> fumigation was 25°C, 75% relative humidity (water vapor saturation deficit of 6 mmHg) and 130 W·m<sup>-2</sup> (30 klx) at plant height. These conditions, known to be favorable for opening of stomata in broad bean (*Vicia faba*) (16), were employed for each of the species tested.

The amount of SO<sub>2</sub> absorbed into the leaves was calculated by integrating the transpiration rate during SO<sub>2</sub> fumigation (Fig. 2). The rate of transpiration was converted

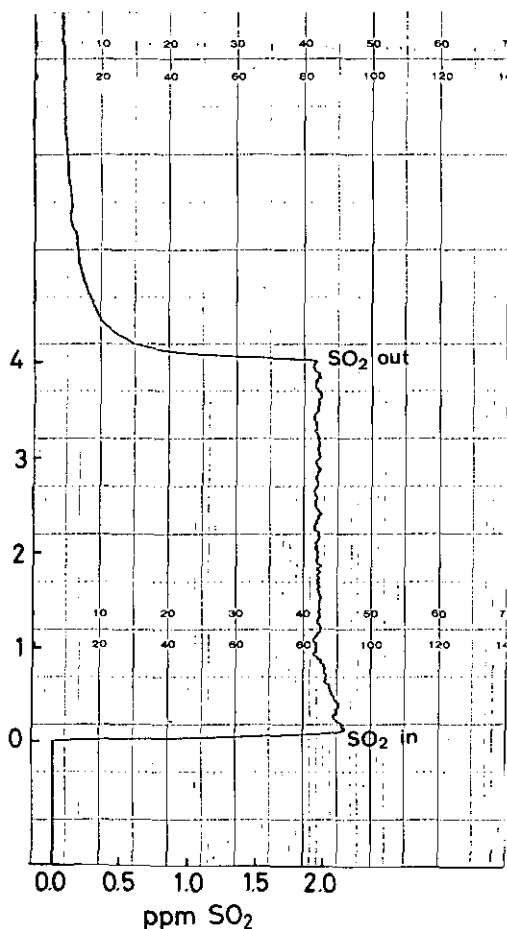

Fig. 1. Record of  $SO_2$  concentration in the fumigation room.

into the rate of  $SO_2$  absorption using the data reported by Omasa and Abo (21). The conversion factor applied was  $1.8 \times 10^{-3}$  [mmHg water vapor saturation deficit]  $\cdot$  [vol ppm  $SO_2$ ] $^{-1}$ .

Foliar injury was determined  $24 \pm 2$  hrs after exposure for each plant species held in the fumigation room in the continuous light. Injury was determined on a 0–100% scale on leaf area basis using 10% increments.

### Results and discussion

#### *Response of transpiration to $SO_2$*

The comparative responses of transpiration in different plant species to 4-hr exposure to 2 ppm  $SO_2$  are presented in Fig. 3.

The pattern of changes in transpiration rate during the course of  $SO_2$  fumigation varied among plant species. For rice and tomato (Fig. 3), the rate of transpiration began

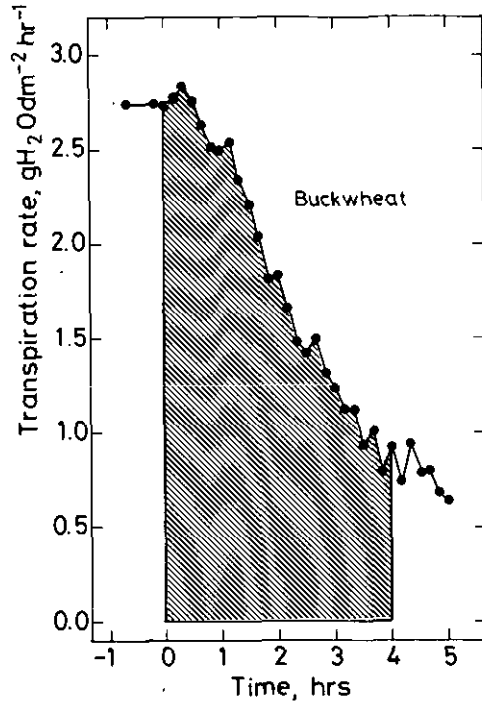

Fig. 2. Method for determination of absorbed amount of  $\text{SO}_2$ . Total absorbed  $\text{SO}_2$  was obtained by integrating transpiration rate (hatched area) during treatment.

to decrease rapidly just after exposure to  $\text{SO}_2$ . The maximum response in the rate of transpiration occurred within 20 min after exposure, the time was consistent between these two plant species. Maximum inhibition of transpiration reached 65% of the pretreatment rate in 2.0 ppm  $\text{SO}_2$ -treated rice and only 35% in 2.0 ppm  $\text{SO}_2$ -treated tomato. No leaves of tomato and rice plants exposed to 2.0 ppm  $\text{SO}_2$  showed visible injury during the course of the 4-hr exposure.

For morning glory and plane tree (Fig. 3), exposure to 2.0 ppm  $\text{SO}_2$  caused the transpiration rates to decline gradually. Decrease in the rate of transpiration of these plant species was slow during the first 2 hr of exposure with a more rapid reduction during the remainder of the treatment. These species were generally more sensitive to  $\text{SO}_2$  than those plant species that showed a rapid decline of transpiration.

For other plant species, e.g. sunflower, pea and buckwheat (Fig. 3), there was a brief initial increase in transpiration followed by a decline over the 4 hr treatment period. The initial increase in transpiration of sunflower was influenced by concentrations of  $\text{SO}_2$  and humidity conditions (data not shown). When the relative humidity was 75% at 25°C (6 mmHg of saturation deficit), the initial increase in transpiration could be noticed. At low relative humidity (12 mmHg of saturation deficit), no stimulation of transpiration was noticed. However, the present results on transpiration indicate that  $\text{SO}_2$  could not stimulate stomata of plant species, including broad bean and corn but excepting

only ginkgo, open for so long time as observed in broad bean, corn and barley by Majernik and Mansfield (15) and Biscoe et al. (7). The increase in transpiration in these plant species tested here continued for 1.5 hr at most.

In higher plants, gaseous diffusion takes place through stomata that are open in the light enabling  $\text{SO}_2$  to enter the leaf tissue quite rapidly. Consequently, the amount of  $\text{SO}_2$  absorbed into leaf tissue depends primarily on the number and size of stomatal pores. However, the reported results concerning stomatal responses to  $\text{SO}_2$  may seem contradictory. Some workers report stimulation of stomatal opening due to  $\text{SO}_2$  fumigation (15, 16, 18), while others have reported stomatal closure during  $\text{SO}_2$  fumigation (19). Summing these contradictory results, Majernik and Mansfield (16) emphasized the importance of the humidity during  $\text{SO}_2$  fumigation. They showed that viscous flow resistance of stomata in broad bean decreased with increasing  $\text{SO}_2$  concentrations up to 9 ppm for 12 hr under moist conditions (less than 7 mmHg of saturation deficit). Under dry conditions and the same range of  $\text{SO}_2$  concentrations, the stomata closed. If exposure to  $\text{SO}_2$  is capable of increasing the stomatal openings a rapid rate of incorporation of  $\text{SO}_2$  into leaf tissue may occur and may result in increased susceptibility to  $\text{SO}_2$  and in increased water loss due to a high transpiration rate. On the other hand, rapid stomatal closure may increase the stomatal resistance to  $\text{SO}_2$  diffusion enabling the plant species to tolerate to  $\text{SO}_2$ . Experimental results obtained by some workers (22) support the speculation that under moist conditions foliar injury due to  $\text{SO}_2$  is more severe than under dry conditions. However, this idea is not entirely supported by the present results.  $\text{SO}_2$  induced the stomatal opening of ginkgo plant, but we could not detect any foliar injury (Fig. 3). Furthermore, we could not detect any correlation between the stomatal closing or opening reaction with the degree of foliar injury induced by  $\text{SO}_2$  fumigation (Fig. 3). However, among the plants we tested, it would appear that those plants showing a rapid response to exposure to  $\text{SO}_2$  (tomato, rice and cucumber) exhibited the least damage. Furthermore, where the transpiration rate was slow to change (stomatal response was minimal) necrosis of the leaf was highest. As indicated above, the ginkgo plants show an entirely different response to  $\text{SO}_2$ , on which, in view of their Mesozoic origins, warrants further examination.

#### *Necrosis and leaf thickness*

The relation between the leaf thickness and foliar injury induced by the 4-hr exposures to 2.0 ppm  $\text{SO}_2$  is indicated in Fig. 4. In the present experiment, there was 10-fold variations in the leaf thickness among the tested plants. The thinnest leaf examined was that of pea with 5.4 mg F.W./ $\text{cm}^2$ , and the thickest leaf was that of lettuce with 51.0 mg F.W./ $\text{cm}^2$ . Linear regression was made to determine whether the leaf thickness was a prominent factor determining the interspecific differences in responses to  $\text{SO}_2$ . From this statistical treatment, there appeared that there was negative correlation between the leaf thickness and the degree of foliar injury. The linear relation was indicated in the figure. However, we could not find a significant correlation between these two factors on 99% confidence level.

As a leaf becomes thicker, the fresh and dry weight per unit area generally increase. Holmgren (14) reported that the mesophyll  $\text{CO}_2$  resistance in ecotypes of *Solidago virgaurea* decreased as the dry weight per unit leaf area increased. Dornhoff and Schibles (10) also found that the rate of photosynthesis for soybean had a positive correlation with leaf fresh weight as well as dry weight per unit leaf area. The mesophyll  $\text{CO}_2$  resistance generally is considerably larger than the boundary layer and the stomatal



Interspecific difference in resistance to  $SO_2$

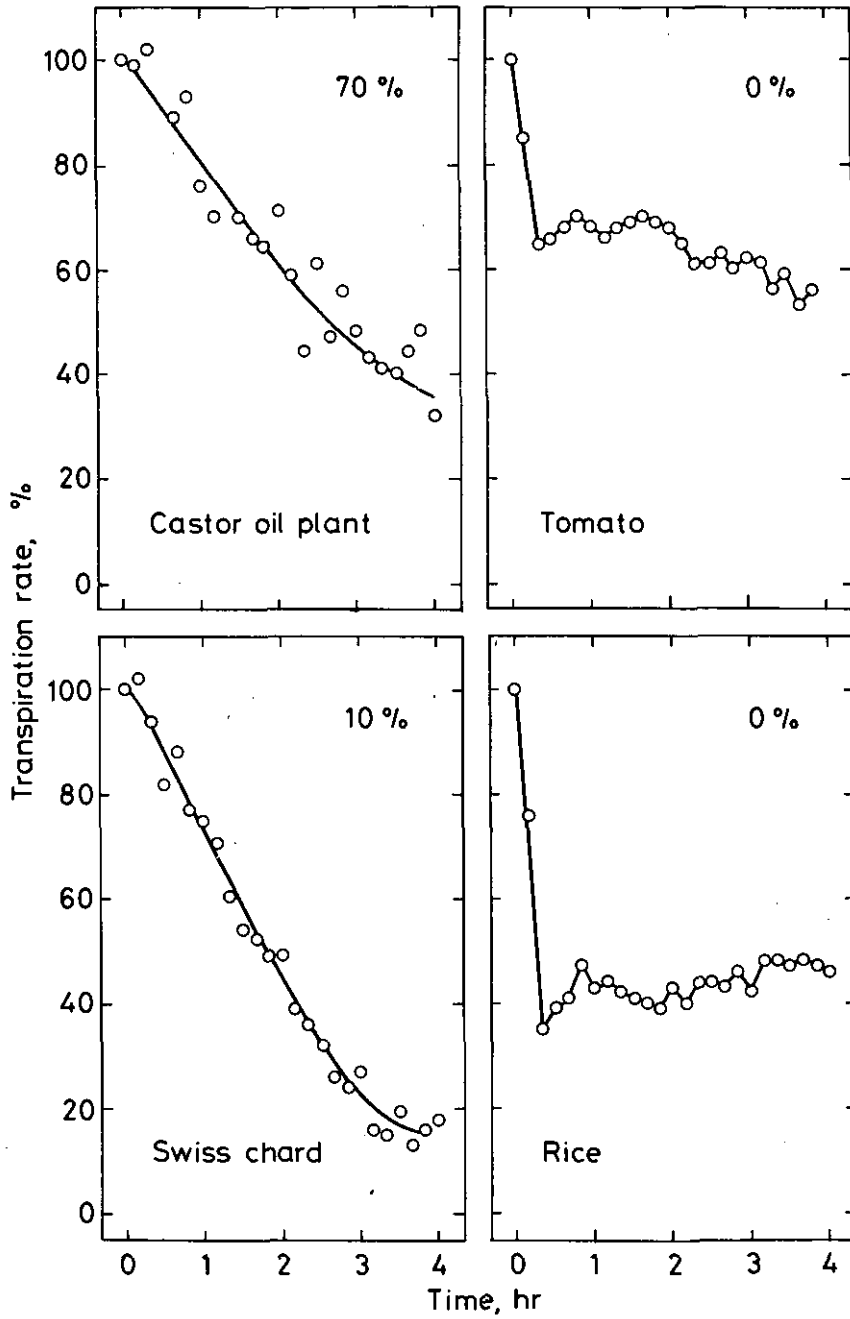

Fig. 3. Effect of 2.0 ppm  $SO_2$  on transpiration rate of various plant species. Percent leaf necrosis is shown for each subfigure.

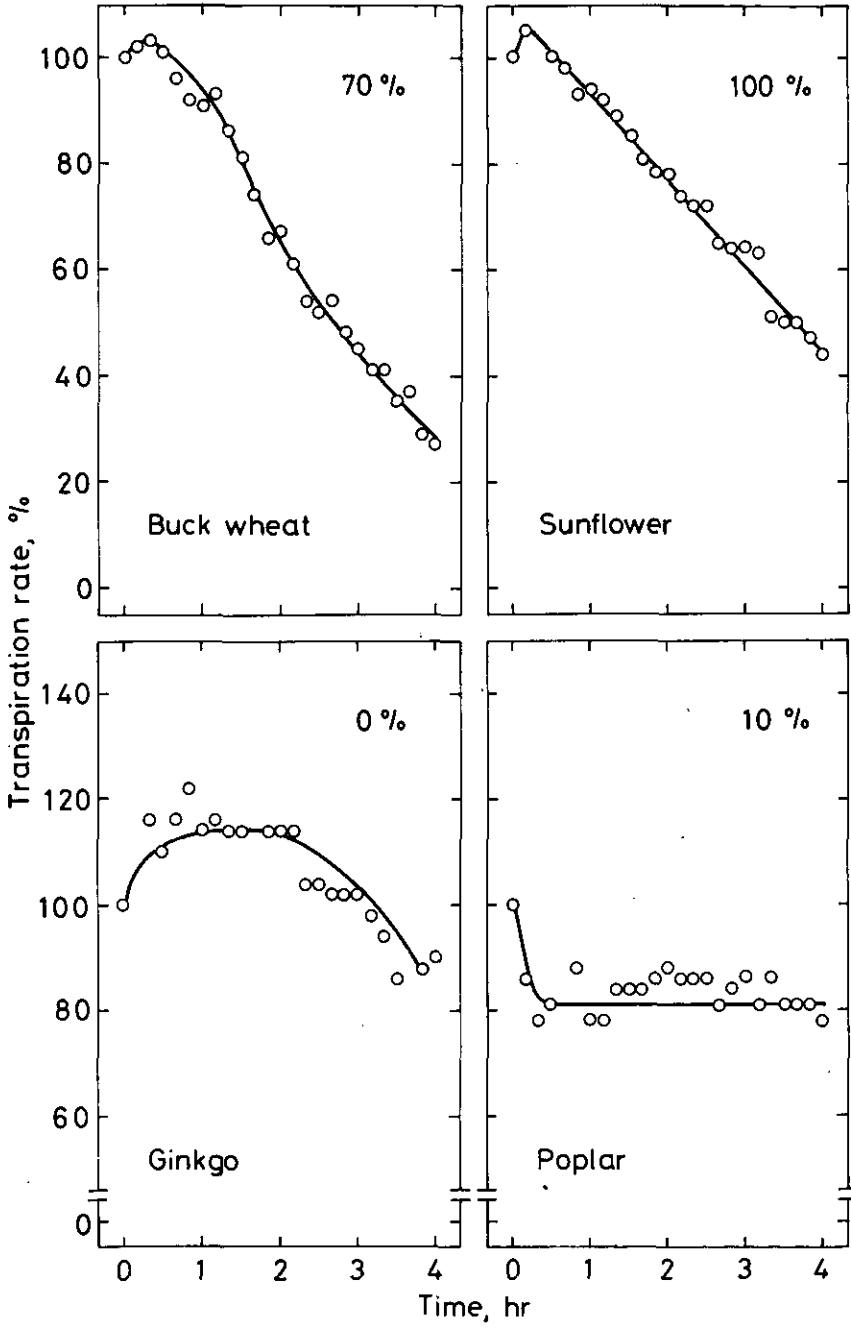

Fig. 3. Continued

Interspecific difference in resistance to  $\text{SO}_2$

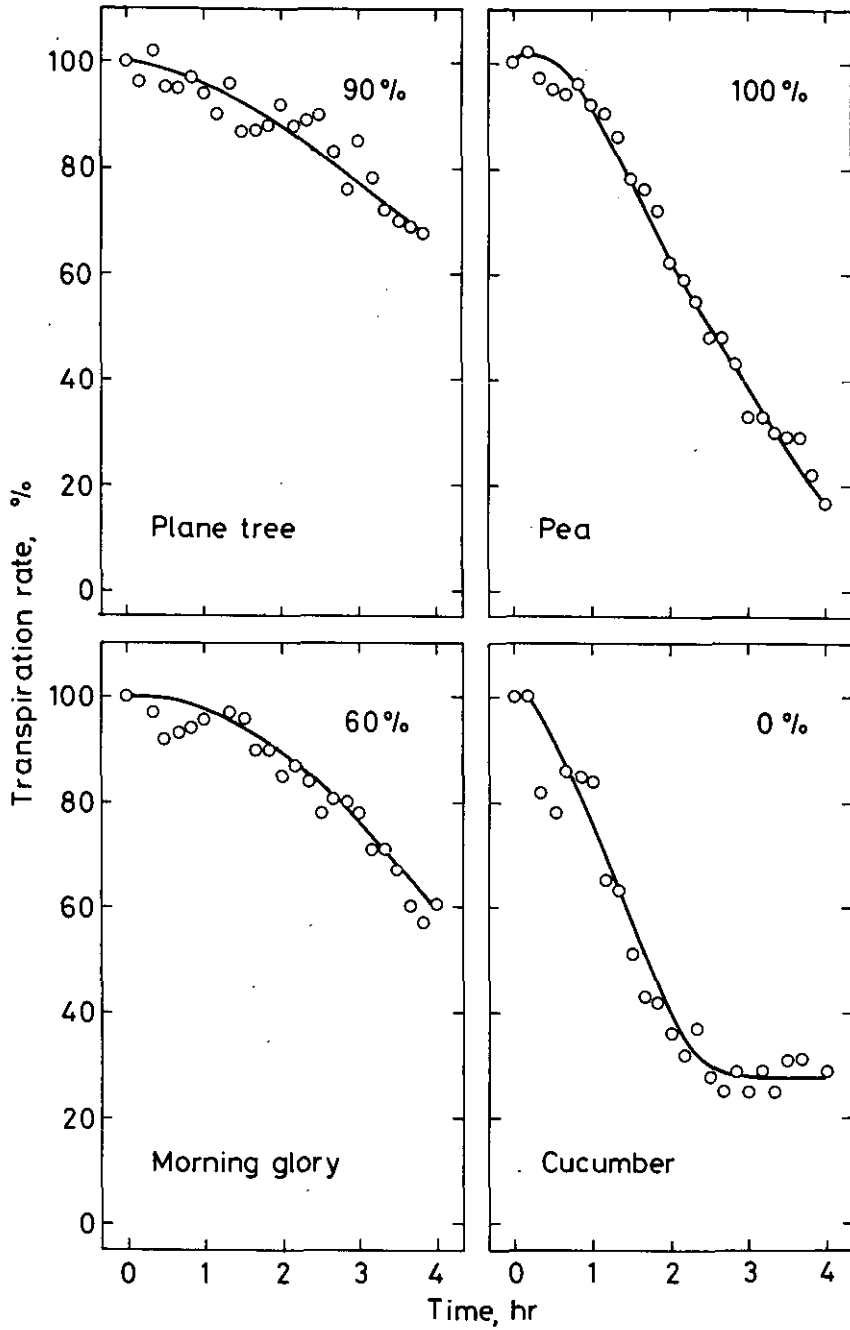

Fig. 3. *Continued*

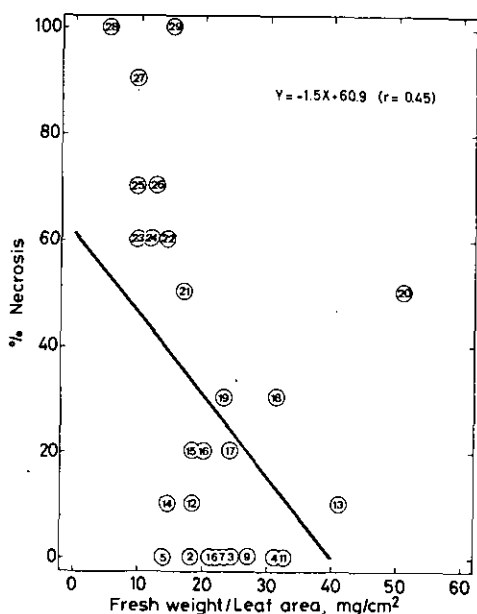

Fig. 4. The degree of leaf necrosis caused by 2.0 ppm  $\text{SO}_2$  as a function of leaf thickness (leaf aerial fresh weight). Solid line is a regression line for the data. Y = the degree of leaf necrosis; X = leaf aerial fresh weight.

resistances to  $\text{CO}_2$  diffusion (12), and hence attention is rightfully directed toward  $\text{SO}_2$  or sulfite diffusion of chloroplasts for understanding the interspecific differences in responses to  $\text{SO}_2$ .

Once  $\text{SO}_2$  enters into the mesophyll tissue through stomata, many physiological and biochemical processes associated with living organisms would be affected (17, 20). The space within the leaf is considered to be 100% relative humidity (11); in addition, mesophyll cells are covered with a thin layer of water. This water layer could alter  $\text{SO}_2$  to sulfite which penetrates into cytoplasm (6) and is converted into sulfate by sulfite oxidation system in plant mitochondria (1, 23). Since sulfite is 30 times more toxic to plant cells than sulfate (25), a rapid conversion of sulfite to sulfate reduces  $\text{SO}_2$  damage. The large resistance of mesophyll tissue to diffusion of sulfite might reduce the toxicity capacity of sulfite. However, we could not detect a significant correlation between leaf thickness and the degree of foliar injury.

#### Necrosis and $\text{SO}_2$ absorption

Fig. 5 shows the relation between the rate of transpiration and the degree of leaf necrosis caused by a 4-hr exposure to 2.0 ppm  $\text{SO}_2$ . The transpiration rate shown in the figure is the rate prior to the fumigation. Values for transpiration rate and the degree of leaf necrosis show a significant (99.9% confidence level) positive correlation ( $r=0.68$ ).

As mentioned above, the absorption rate of  $\text{SO}_2$  is due to stomatal resistance to the diffusion of gases. Furthermore, stomatal diffusion resistance can be determined by the transpiration rate and leaf air vapour pressure difference (12). The transpiration rate is

### Interspecific difference in resistance to SO<sub>2</sub>

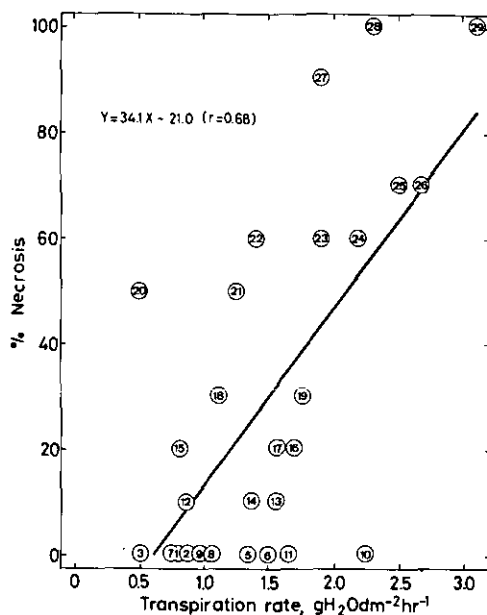

Fig. 5. The degree of leaf necrosis caused by 2.0 ppm SO<sub>2</sub> as a function of transpiration rate. The transpiration rate is the rate prior to SO<sub>2</sub> fumigation. Solid line is a regression line for the data. Y = the degree of leaf necrosis; X = the rate of transpiration prior to SO<sub>2</sub> fumigation.

therefore an indicator of the SO<sub>2</sub> absorption rate. The results shown in Fig. 5 indicate that degree of foliar injury may depend on the rate of SO<sub>2</sub> absorption. However, the transpiration rate shown in Fig. 5 is the rate prior to the fumigation. Although the degree of leaf necrosis has a highly significant correlation with the pre-exposure rate of transpiration, it is questionable that the degree of leaf necrosis is determined solely by the rate of transpiration, or in other words the rate of SO<sub>2</sub> absorption, because the transpiration rate changed during exposure to SO<sub>2</sub>. In addition, the changes in transpiration due to exposure to SO<sub>2</sub> had great variabilities between plant species (Fig. 3).

Assuming the absorption of SO<sub>2</sub> is directly related to the transpiration rate during the course of the experiment, then the degree of leaf necrosis should have higher correlation with the total amount of SO<sub>2</sub> absorbed during the exposure. The relationship between the absorbed amount of SO<sub>2</sub> and the degree of leaf necrosis strengthens this argument that species differences in resistance to SO<sub>2</sub> appear to be mainly due to differences in the absorbed amount of SO<sub>2</sub> rather than the rate of absorption of SO<sub>2</sub>. This is shown in Fig. 6 where a correlation of 0.78 was obtained between the amount of SO<sub>2</sub> absorbed and the degree of leaf necrosis. The total amount of SO<sub>2</sub> absorbed was determined by integrating transpiration during SO<sub>2</sub> fumigation as indicated in Fig. 2. These results provide direct evidence in support of Thomas's idea (25) that species differences in resistance to SO<sub>2</sub> are the result of absorption differences.

The correlation between the absorbed amount of SO<sub>2</sub> and the degree of foliar injury

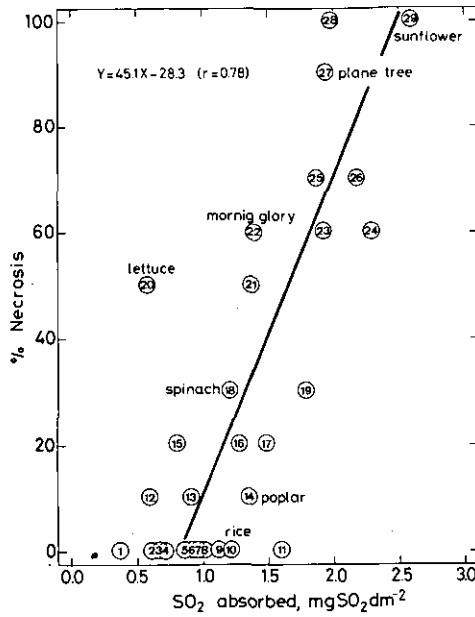

Fig. 6. The degree of leaf necrosis caused by 2.0 ppm SO<sub>2</sub> as a function of the amount of SO<sub>2</sub> absorbed. Solid line is a regression line for the data. Y = the degree of leaf necrosis; X = the amount of SO<sub>2</sub> absorbed.

could be used to develop conceptual models on the interspecific differences in resistance to SO<sub>2</sub>. Possibly, these results could be used as a general conceptual model for grading plant species in responses to SO<sub>2</sub>.

### Conclusions

Evidence provided in this paper indicates that the degree of leaf necrosis could be due to the amount of SO<sub>2</sub> absorbed during the fumigation. Plants sensitive to SO<sub>2</sub> absorb greater amounts of SO<sub>2</sub> than resistant plant species. Although ambient SO<sub>2</sub> concentrations are much lower than the concentration applied in the present experiment and leaf necrosis caused by other air pollutants was not detected, the present evidence may be able to apply to the interspecific differences in the resistance to other air pollutants because the uptake of gases are primarily due to the stomatal diffusion resistance (6, 21). (We have now conducted experiments to check this speculation by determining the relationship between leaf necrosis and ozone absorption.)

If vegetation does constitute an important sink or filter for atmospheric pollutants, as suggested by a number of investigators (4, 5), then plants which have high absorbing capacity of air pollutants would play a beneficial role in this phenomenon. However, those leaves which could absorb air pollutants efficiently could not tolerate higher concentrations of air pollutants. On the other hand, planting the resistant species is not beneficial for cleaning phytotoxic air pollutants from the atmosphere, because the highly resistant species do not absorb air pollutants efficiently.

Trees and woody shrubs are planted as a greenbelt or along roads in heavily polluted urban areas. Tree species have larger amount of leaves with longer life-span than herbaceous species. This characteristics of tree species may be more beneficial for removing air pollutants. Thus, if we want to use vegetation as atmospheric filters then woody species would be more beneficial than herbaceous ones.

## References

1. Ballantyne, D.J.: Sulfite oxidation by mitochondria from green and etiolated peas. *Phytochem.* 16: 49-50 (1977).
2. Barrett, T.W. and H.M. Benedict: Sulfur dioxide. In *Recognition of Air Pollution Injury to Vegetation: A Pictorial Atlas*. Edited by J.S. Jacobson and A.C. Hill. C1-C17. Air Pollution Control Association, Pittsburg and Pennsylvania, 1970.
3. Bell, J.N.B. and C.H.Mudd: Sulphur dioxide resistance in plants: A case study of *Lolium perenne*. In *Effects of Air Pollutants on Plants*. Edited by T.A. Mansfield. p. 87-104. Cambridge University Press, London, 1976.
4. Bennett, J.H. and A.C. Hill: Absorption of gaseous air pollutants by a standardized plant canopy. *J. Air Poll. Cont. Assoc.* 23: 203-206 (1973).
5. Bennett, J.H. and A.C. Hill: Interactions of air pollutants with canopies of vegetation. In *Responses of Plants to Air Pollution*. Edited by J.B. Mudd and T.T. Kozlowski. p. 273-306. Academic Press, New York, San Francisco and London, 1975.
6. Bennett, J.H., A.C. Hill and D.M. Gates: A model for gaseous pollutant sorption by leaves. *J. Air Poll. Cont. Assoc.* 23: 957-962 (1973).
7. Biscoe, P.W., M.H. Unsworth and H.P. Pinckney: The effects of low concentrations of sulphur dioxide on stomatal behaviour in *Vicia faba*. *New Phytol.* 72: 1299-1306 (1973).
8. Bressan, R.A., L.G. Wilson and P. Filner: Mechanisms of resistance to sulfur dioxide in the cucurbitaceae. *Plant Physiol.* 61: 761-767 (1978).
9. Caput, C., Y. Belot, D. Auclair and N. Decourt: Absorption of sulphur dioxide by pine needles leading to acute injury. *Environ. Pollut.* 16: 3-15 (1978).
10. Dornhoff, G.M. and R.M. Shibles: Varietal differences in net photosynthesis of soybean leaves. *Crop Sci.* 10: 42-45 (1970).
11. Farguhar, G.D. and K. Raschke: On the resistance to transpiration of the sites of evaporation within the leaf. *Plant Physiol.* 61: 1000-1005 (1978).
12. Gaastra, P.: Photosynthesis of crop plants as influenced by light, carbon dioxide, temperature, and stomatal resistance. *Meded. Landbouwhoges. Wageningen* 59: 1-68 (1959).
13. Hill, A.C., S. Hill, C. Lamb and T.W. Barrett: Sensitivity of native desert vegetation to SO<sub>2</sub> and to SO<sub>2</sub> and NO<sub>2</sub> combined. *J. Air Poll. Cont. Assoc.* 24: 153-157 (1974).
14. Holmgren, P.: Leaf factors affecting light-saturated photosynthesis in ecotypes of *Solidago virgaurea* from exposed and shaded habitats. *Physiol. Plant.* 21: 676-698 (1968).
15. Majernik, O. and T.A. Mansfield: Effects of SO<sub>2</sub> pollution on stomatal movements in *Vicia faba*. *Phytopathol.* Z. 71: 123-128 (1971).
16. Majernik, O. and T.A. Mansfield: Stomatal responses to raised atmospheric CO<sub>2</sub> concentrations during exposure of plants to SO<sub>2</sub> pollution. *Environ. Pollut.* 3: 1-7 (1972).
17. Malhotra, S.S. and D. Hocking: Biochemical and cytological effects of sulphur dioxide on plant metabolism. *New Phytol.* 76: 227-237 (1976).
18. Mansfield, T.A. and O. Majernik: Can stomata play a part in protecting plants against air pollution? *Environ. Pollut.* 1: 149-154 (1970).
19. Menser, H.A. and H.E. Heggstad: Ozone and sulfur dioxide synergism: injury to tobacco plants. *Science* 153: 424-425 (1966).
20. Mudd, J.B.: Biochemical effects of some air pollutants on plants. In *Air Pollution Damage to Vegetation*. Edited by J.A. Naegele, p. 31-47, American Chemical Society, 1973.
21. Mudd, J.B.: Sulfur dioxide. In *Responses of Plants to Air Pollution*. Edited by J.B. Mudd and T.T. Kozlowski, p. 9-22, Academic Press, New York, San Francisco and London, 1975.
22. Omasa, K. and F. Abo: Studies of air pollutant sorption by plants. (I) Relation between local SO<sub>2</sub> sorption and acute visible leaf injury. *J. Agr. Met.* 34: 51-58 (1978).

23. Setterstrom, C. and P.W.Zimmerman: Factors influencing susceptibility of plants to sulphur dioxide injury I. *Cont.Boyce Thompson Inst.* 10: 155-181 (1939).
24. Tager, J.M. and N.Ranatnen: Sulfite oxidation by a plant mitochondrial system. Preliminary observations. *Biochem. Biophys. Acta* 18: 111-121 (1955).
25. Thomas, M.D.: Gas damage to plants. *Ann.Rev.Plant Physiol.* 2: 293-322 (1951).
26. Thomas, M.D.: Effects of air pollution on plants. In *Air Pollution*. WHO Monogr. Ser. 46: 233-277 (1951).
27. Thomas, M.D. and R.H. Hendricks: Effect of air pollution on plants. In *Air Pollution Handbook*. Edited by P.L. Magill, F.R.Holden, C.Ackly and F.G. Sawyer, p.9, 1 - 9, 44, McGraw-Hill, New York, Toronto and London, 1956.
28. Thomas, M.D. and G.R.Hill: Absorption of sulfur dioxide by alfalfa and its relation to leaf injury. *Plant Physiol.* 10: 291-307 (1935).



## Abscisic acid-dependent changes in transpiration rate with SO<sub>2</sub> fumigation and the effects of sulfite and pH on stomatal aperture

Noriaki Kondo<sup>1</sup>, Issey Maruta<sup>2</sup> and Kiyoshi Sugahara<sup>1</sup>

<sup>1</sup>Division of Environmental Biology, The National Institute for Environmental Studies,  
Yatabe, Ibaraki 305

<sup>2</sup>The Graduate School of Environmental Science, The University of Tsukuba,  
Sakura-mura, Ibaraki 305

Transpiration rate of rice plant which contained extremely large amount of abscisic acid (ABA) decreased rapidly with 2.0 ppm SO<sub>2</sub> fumigation, reached 20% of the initial level after 5 min exposure, then recovered slightly and thereafter remained constant. SO<sub>2</sub> fumigation of alday and tobacco (*Nicotiana tabacum* L. Samsun) which have a lower ABA content showed a 50% decrease in transpiration rate. Similarly, rates for wheat and tobacco (*N. tabacum* L. Samsun NN) which contained even smaller amounts of ABA than alday and tobacco (Samsun) decreased by 35 and 45%, respectively, 30 min after the beginning of the fumigation. In the cases of broad bean and tobacco (*N. glutinosa* L.) with low ABA contents, the rates slightly increased immediately after the start of the fumigation and began to decrease gradually 20 and 40 min later, respectively. The transpiration rates of corn and sorghum, in spite of their extremely low ABA contents, pronouncedly decreased with SO<sub>2</sub> fumigation and reached 65 and 50% of the initial levels after 20 to 40 min exposure, respectively. Foliar application of 0.04 N HCl to peanut leaves remarkably depressed the transpiration rate, while the application of 0.04 M Na<sub>2</sub>SO<sub>3</sub> decreased the rate only to the same level as water treatment. Foliar application of either HCl or Na<sub>2</sub>SO<sub>3</sub> to radish leaves exerted no change in the transpiration rate. When  $3 \times 10^{-4}$  M ABA was applied to radish leaves prior to HCl and Na<sub>2</sub>SO<sub>3</sub> treatment, the transpiration rate of radish was decreased by HCl application, but not by Na<sub>2</sub>SO<sub>3</sub>. The stomatal aperture size of sonicated epidermal strips peeled from broad bean leaves was identical in a pH range of 3.0 to 7.0 in the medium. Addition of 10<sup>-7</sup> M ABA to the medium decreased the aperture size in the acidic region of pH with a minimal value at pH 4.0. Na<sub>2</sub>SO<sub>3</sub> produced a slight increase in the aperture size in the absence of ABA, but showed no effect in the presence of ABA.

Key words: Abscisic acid - pH - Stomata - Sulfite - Sulfur dioxide - Transpiration.

The injury caused by SO<sub>2</sub> fumigation depends at least partly on entry of the gas through the stomata. The number and aperture size of stomata are important in determining plant sensitivity to SO<sub>2</sub>. However, these stomatal characteristics do not always correlate with plant resistance to SO<sub>2</sub> (3, 4). Recently, we found that the transpiration rates of resistant plants rapidly decreased following SO<sub>2</sub> fumigation, while those of sensitive ones gradually decreased after some lag periods or even slightly increased

(7). We also demonstrated that the transpiration rate of the leaves containing high concentrations of ABA rapidly decreased with SO<sub>2</sub> fumigation. These results suggest that ABA may act as a controlling factor for protection of plants from SO<sub>2</sub> damage. As ABA is known to decrease the stomatal aperture (10), SO<sub>2</sub> seems likely to amplify the inhibitory action of ABA on the stomatal opening or sensitize the guard cells to ABA. SO<sub>2</sub> absorbed by plant leaves through stomata dissolves and is transformed into sulfite and/or bisulfite ions followed by simultaneous proton generation on wet surface of guard cells and in cytoplasmic fluid. Therefore, the effects of SO<sub>2</sub> on the stomatal movement must be derived from sulfite or bisulfite ion and/or lowering the pH.

Stomatal movement depends on some metabolic reactions (9, 10). To clarify the metabolic processes included in stomatal behaviors, methods were developed to obtain pseudo-isolated guard cells, i.e., rolling (2) and sonication (6) to clear cells other than guard cells from epidermal strips. The present study shows the changes in transpiration rate following SO<sub>2</sub> fumigation and ABA content in the leaves using broad bean, three species of tobacco and five species of Gramineae plants including two species of C<sub>4</sub> plants, and confirms ABA involvement in the stomatal responses to SO<sub>2</sub> fumigation with the exception of C<sub>4</sub> plants. Moreover, to investigate the stomatal behavior on SO<sub>2</sub> fumigation, the effects of pH and sulfite in the presence or absence of ABA were studied on the aperture size of stomata in epidermal strips peeled from broad bean leaves.

### Materials and methods

#### *Plant materials*

Rice (*Oryza sativa* L. cv. Nihonbare), alday (*Coix Ma-yuen* Roman) and wheat (*Triticum aestivum* L. cv. Norin No.61) were grown for about 8 weeks at 25 ± 0.5°C with a relative humidity of 70 ± 5% in an environment-controlled glass house under natural light conditions. Corn (*Zea mays* L. cv. Yellow Dent-corn), sorghum (*Sorghum vulgare* Rers.), broad bean (*Vicia faba* L. cv. Otafuku), peanut (*Arachis hypogaea* L. cv. Chibahandachi) and radish (*Raphanus sativus* L. cv. Minowase) were grown for about 4, 6, 6-7, 8 and 4 weeks, respectively in the same conditions as described above. Tobacco (*Nicotiana tabacum* L. cv. Samsun and Samsun NN and *N. glutinosa* L.) plants were grown for about three months after sowing in a greenhouse where temperature was maintained between 20 and 28°C.

#### *SO<sub>2</sub> fumigation and measurement of transpiration rate*

The test plants were transferred to a growth cabinet (170 × 230 × 190 cm) for SO<sub>2</sub> fumigation. The plants were preconditioned for 2 hr to achieve the steady state of stomatal aperture in the cabinet at 25 ± 0.5°C with a relative humidity of 75 ± 3% under light intensity of 25,000 to 35,000 lux at leaf level. The light was obtained from 24 metal halide lamps (400W; Yoko Lamp, Toshiba) which were passed through filter glasses to eliminate heat radiation. SO<sub>2</sub> fumigation at 2.0 ± 0.08 ppm (moles/moles) was performed by diluting 6,000 ppm SO<sub>2</sub> in nitrogen with air. Transpiration rate was measured by the rate of decrease in the weight of the pot containing plants. Transpiration rates were reported for a common leaf area (100 cm<sup>2</sup>) to allow comparison between plants. The pot was covered with a vinyl sheet to prevent evaporation of water from the soil surface and placed on a balance (Mettler PE 11) equipped with an amplifier (Mettler BE 13) and a recorder (Technicorder F Type 3052, Yokogawa). The change in the pot weight was continuously recorded.

*Extraction and measurement of ABA*

Approximately 3 to 5 g of leaves of the test plants were randomly excised and weighed as fast as possible. Next, the leaves were immersed in ice-cold 60 ml of methanol-ethyl acetate-acetic acid (50:50:1, v/v) containing 20 mg/liter butylated hydroxy toluene, homogenized in a homogenizer (Polytron, Kinematica) and allowed to stand overnight at 4°C. The homogenate was then centrifuged for 10 min at 7,000 × g at 4°C. The extraction was repeated, and the extracts were combined and concentrated in an evaporator at 40°C to aqueous phase. The aqueous solution was diluted with distilled and deionized water up to 50 ml, and first partitioned 3 times against equal volumes of *n*-hexane at pH 2.5, and thereafter against equal volumes of dichloromethane 3 times at pH 9.0 and then 3 times at pH 2.5. The acidic dichloromethane extracts were combined and evaporated to dryness. The dried extract was dissolved in small amount of ethyl acetate and loaded on 20 × 20 cm<sup>2</sup>, 0.2-mm-thick plates of silica gel 60 F<sub>254</sub> (Merck). Authentic *cis-trans* ABA (Sigma) was placed on either side of the streak and the plates were developed with toluene-ethyl acetate-acetic acid (40:5:2, v/v). After developing, ABA was located under ultraviolet radiation (F1-3S UV lamp, Tokyo Kogaku) and the corresponding zones were marked. The zones were scraped off the plates and eluted with water-saturated ethyl acetate. The eluates were dried in an evaporator and methylated with diazomethane. The methylated substances were evaporated again to dryness, dissolved in 0.2 ml of ethyl acetate and analyzed by gas-liquid chromatography with a gas chromatograph (Hitachi 163) fitted with a <sup>63</sup>Ni electron-capture detector. One μl of the sample was injected onto the glass column, 0.3 cm diameter, 2 m long, packed with 1% XE 60 on AW-DMCS Chromosorb W. The carrier gas was nitrogen with a flow rate of 50 ml/min. The oven temperature and the detector and injector temperature were 200 and 240°C, respectively. ABA was quantified by measuring the area under the peak. Each sample was measured 3 times. Values in Table 1 are averages of the quantities of two samples.

*Preparation and sonication of epidermal strips*

Broad bean test plants were placed in the growth cabinet for 2 to 4 hr at 25°C under light illumination of about 35,000 lux before harvesting the leaves. Epidermal strips were peeled from the abaxial (lower) leaf surface and put into a solution of 10 mM KCl and 0.1 mM CaCl<sub>2</sub>. The peeled epidermal strips were sonicated for 2 min with a 20-KC ultrasonic disruptor (A350G, Ultrasonic) and washed with a fresh solution of KCl and CaCl<sub>2</sub>. Microscopic observations showed that no mesophyll cells adhered to the sonicated strips.

*Measurement of stomatal aperture size in epidermal strips*

The sonicated epidermal strips were transferred to 10 ml of buffer solution containing 10 mM KCl and 0.1 mM CaCl<sub>2</sub> in the presence or absence of mixed isomer of *cis-trans* and *trans-trans* ABA (Sigma) and/or Na<sub>2</sub>SO<sub>3</sub> in vials. When the effect of pH was examined, a tenth strength of McIlvaine's buffer was used, unless otherwise mentioned. In the other cases, 10 mM MES buffer was also used besides McIlvaine's buffer. The vials were placed in a water bath kept at 25°C and illuminated at about 40,000 lux. Illumination was obtained from a 300 W incandescent lamp passed through 5-cm-thick water layer to eliminate heat radiation. After incubation for 1.5 to 2.0 hr, epidermal strips were photographed and stomatal aperture size was measured. Values represented in Figs and Table 2 are averages of measurements of about 30 to 50 stomata with standard errors.

## Results

*Changes in transpiration rate with SO<sub>2</sub> fumigation*

Fig. 1 shows the change in transpiration rate of tobacco plants with SO<sub>2</sub> fumigation. The transpiration rates of *N. tabacum* L. cv. Samsun and Samsun NN began to decrease rapidly within 10 min after the start of SO<sub>2</sub> fumigation, reached 50 and 55% of the initial levels after 30 min exposure, respectively, and thereafter decreased very slowly. On the other hand, the transpiration rate of *N. glutinosa* L. did not change for 40 min after the beginning of fumigation, then decreased gradually. Fig. 2 shows the change in transpiration rate of broad bean and five species of Gramineae with SO<sub>2</sub> fumigation. The transpiration rate of rice plant declined immediately to 20% of the initial rate in 5 min after initiation of fumigation, then recovered slightly and thereafter the level was maintained. Those of alday and corn decreased also rapidly following fumigation, 20 min later fell to 50 and 65% of the levels prior to the fumigation, respectively, and then remained constant. The transpiration rate of wheat also decreased by 30% after 20 min exposure. The level was maintained for 1 hr, and then began to decrease gradually. In the case of sorghum, the rate began to decrease within 10 min after the start of the fumigation and reached 50% of the initial level 40 min later. The transpiration rate of broad bean plant did not change or even increased slightly during 20 min after the start of fumigation, then declined continuously with a slight oscillation.

*Amount of ABA in plant leaves*

Table 1 presents the ABA content in the leaves of test plants. The ABA content in

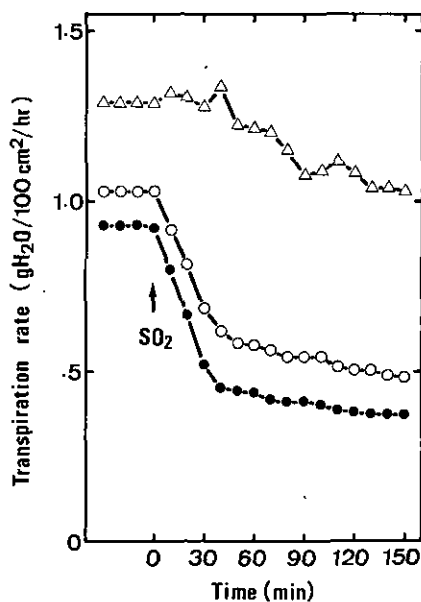

Fig. 1. Changes in transpiration rate of tobacco plants with SO<sub>2</sub> fumigation. Tobacco (*N. tabacum* L. cv. Samsun; —●—, and Samsun NN; —○—, and *N. glutinosa* L.; —△—) plants were preconditioned for about 2 hr in the growth cabinet prior to 2.0 ppm SO<sub>2</sub> fumigation. SO<sub>2</sub> gas was introduced into the cabinet at 0 time indicated by the arrow.

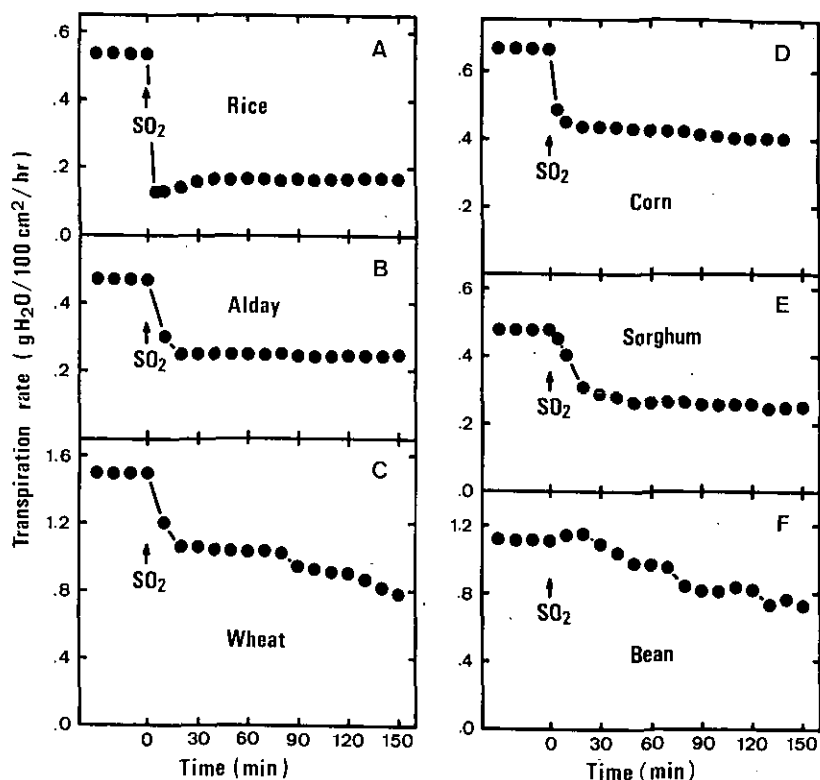

Fig. 2. Changes in transpiration rate of Gramineae, rice (A), alday (B), wheat (C), corn (D) and sorghum (E), and broad bean (F) with SO<sub>2</sub> fumigation. SO<sub>2</sub> fumigation was performed in the same manner as described in the legend to Fig. 1.

rice was highest and almost equal to that in peanut. The contents in *N. tabacum* L. cv. Samsun and alday were second followed by *N. tabacum* L. cv. Samsun NN and wheat. The content of ABA in *N. glutinosa* L., sorghum, broad bean and radish was low. The content in corn was extremely low.

#### The effect of foliar application of Na<sub>2</sub>SO<sub>3</sub> and HCl on the transpiration rate

The effects of foliar application of Na<sub>2</sub>SO<sub>3</sub> and HCl on the transpiration rate were tested using peanut and radish plants. After attaining a steady transpiration rate, distilled and deionized water, 0.04 M Na<sub>2</sub>SO<sub>3</sub> or 0.04 N HCl was applied to the leaves, and the measurement of transpiration rate was continued. Application of water alone partly closed pairs of leaflets of peanut. This was followed by a decrease in transpiration rate, later the rate gradually recovered (Fig. 3). The rate of change in transpiration rate of peanut leaves applied with Na<sub>2</sub>SO<sub>3</sub> was same as that for water, while application of HCl depressed the transpiration rate of peanut to 70% of the water level. On the other hand, the application of Na<sub>2</sub>SO<sub>3</sub> and HCl did not influence the transpiration rate of radish (data not shown). The application of  $3 \times 10^{-4}$  M ABA alone to radish leaves decreased the transpiration rate by about 30% of the initial level. Subsequent application of HCl further

Table 1 ABA content in leaves of test plants

	ABA content <sup>a</sup> (ng/g fr.wt)
Tobacco	
<i>Nicotiana tabacum</i> L. Samsun	283
<i>N. tabacum</i> L. Samsun NN	120
<i>N. glutinosa</i> L.	12
Rice	530
Alday	269
Wheat	177
Corn	3
Sorghum	18
Broad bean	42
Peanut	438 <sup>b</sup>
Radish	37 <sup>b</sup>

Each sample was measured three times.

<sup>a</sup> Average of two samples

<sup>b</sup> Data from Reference (7)

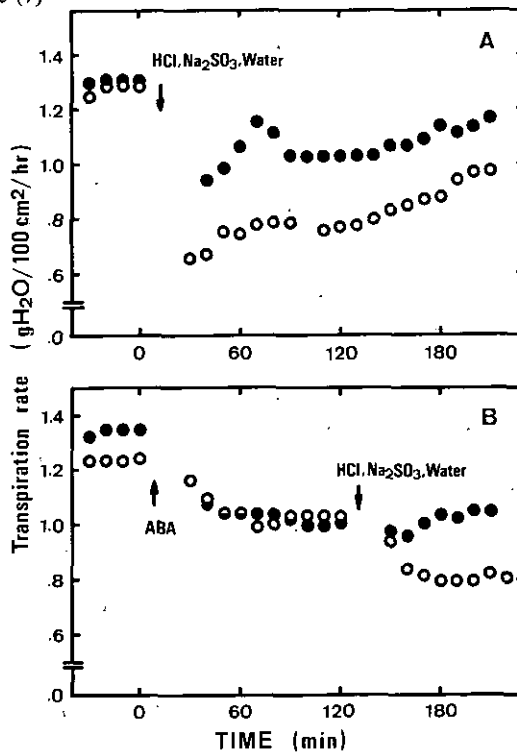

Fig. 3. Effects of foliar application of HCl and Na<sub>2</sub>SO<sub>3</sub> on the transpiration rate of peanut (A) and radish (B). 0.04 N HCl (○), 0.04 M Na<sub>2</sub>SO<sub>3</sub> and deionized water (●) were exogenously applied at 0 time (A) or at 120 min (B). In B, 3 × 10<sup>-4</sup> M ABA was applied at 0 time.

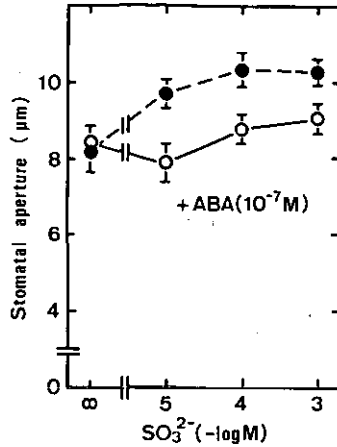

Fig. 4. Effects of sulfite on the stomatal aperture size in the epidermal strips. Sonicated epidermal strips peeled from broad bean leaves were placed in 10 ml of 10 mM MES buffer (pH 6.0) containing 10 mM KCl, 0.1 mM  $\text{CaCl}_2$  and various concentrations of  $\text{Na}_2\text{SO}_3$  in the presence (—○—) or absence (—●—) of  $10^{-7} M$  ABA. After 1.5 to 2.0 hr incubation at  $25^\circ\text{C}$  under about 40,000 lux, stomata were photographed and the aperture size was measured. Vertical bars represent the standard errors.

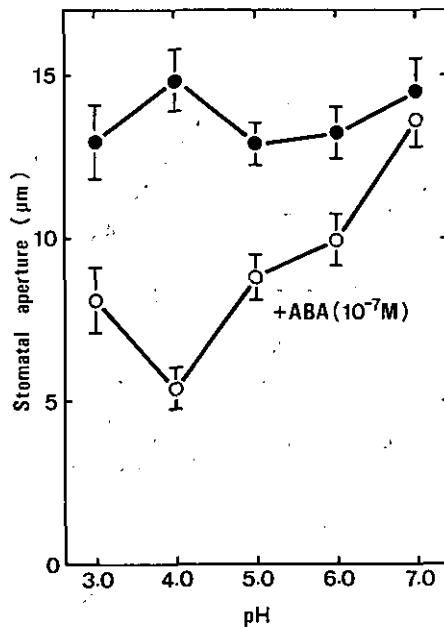

Fig. 5. Effects of pH on the stomatal aperture size in the epidermal strips. Sonicated epidermal strips peeled from broad bean leaves were placed in 10 ml of a tenth strength of McIlvaine's buffer with different pH containing 10 mM KCl and 0.1 mM  $\text{CaCl}_2$  in the presence (—○—) or absence (—●—) of  $10^{-7} M$  ABA. Incubation and measurement as described in the legend to Fig. 4.

Table 2 *Effects of different buffers on the stomatal aperture size in the epidermal strips of broad bean*

Buffer <sup>a</sup>	Stomatal aperture ( $\mu\text{m}$ ) <sup>b</sup>		
	pH	-ABA	+10 <sup>-7</sup> M ABA
Mcllvaine	4.5	9.57 $\pm$ 0.48 (52)	5.99 $\pm$ 0.37 (51)
Mcllvaine	7.0	10.73 $\pm$ 0.56 (46)	11.68 $\pm$ 0.31 (49)
Glycine-NaCl-HCl	4.5	10.02 $\pm$ 0.39 (48)	6.55 $\pm$ 0.25 (47)
Tris-maleate	7.0	9.85 $\pm$ 0.37 (48)	10.63 $\pm$ 0.33 (45)

<sup>a</sup> A tenth strength of each buffer used.

<sup>b</sup> Each value with standard error. Figures in parentheses representing the number of stomata measured.

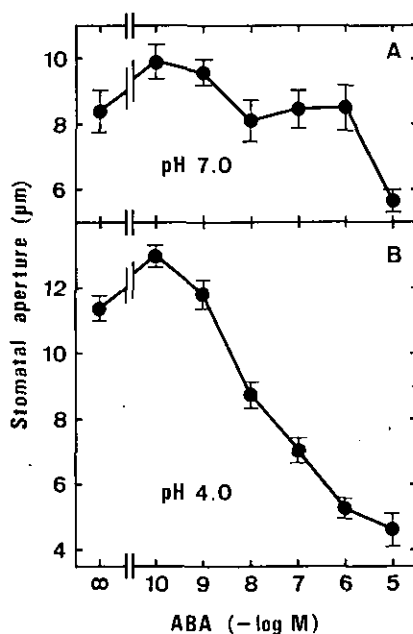

Fig. 6. *Effects of ABA concentration on the stomatal aperture size in the epidermal strips at pH 7.0 (A) and 4.0 (B). The pH was adjusted with a tenth strength of Mcllvaine's buffer containing 10 mM KCl and 0.1 mM CaCl<sub>2</sub>. Incubation and measurement as described in the legend to Fig. 4.*

decreased the rate by about 20%, whereas the sulfite application exerted little effect on the transpiration rate.

#### *Effects of sulfite and pH on the stomatal aperture size in sonicated epidermal strip*

Fig. 4 shows the effect of sulfite on stomatal aperture size in the presence or absence of 10<sup>-7</sup> M ABA. Sulfite concentrations between 10<sup>-5</sup> and 10<sup>-3</sup> M increased the stomatal aperture slightly in the absence of ABA. In the presence of 10<sup>-7</sup> M ABA, no effect of



sulfite was observed. Sulfite gave no effect on the stomatal aperture even when higher concentrations of ABA were present (data not shown), although ABA alone reduced the aperture size. Aperture size remained unchanged in a pH range of 3 to 7 in the absence of ABA (Fig. 5). On the other hand, at a pH of 4.0 with ABA the aperture size was markedly reduced. This inhibitory effect of ABA on the stomatal aperture size at a low pH was also observed using other buffer solutions (Table 2). ABA concentrations above  $10^{-8}$  M were effective in the reduction of aperture size at pH 4.0, while concentrations above  $10^{-6}$  M were necessary to reduce the stomatal aperture size at pH 7.0 (Fig. 6). These results show that lowering the pH of the medium may amplify the inhibitory action of ABA on stomatal opening.

### Discussion

In a previous paper (7), we reported that the transpiration rate of the plants with a high ABA content rapidly decreased when fumigated with SO<sub>2</sub>. In the present study using three species in the same genus, tobacco and five species in the same family, Gramineae, the previous observation was confirmed for C<sub>3</sub> plants, while C<sub>4</sub> plants, corn and sorghum were not the case. Whether such exceptions are restricted to C<sub>4</sub> plants such as corn and sorghum or not is not known. As shown in Fig. 1 and 2, the transpiration rate prior SO<sub>2</sub> fumigation was greatly different among plant species. In addition, the transpiration rate of plants with a small inherent transpiration rate was rapidly decreased by SO<sub>2</sub> fumigation. However, such a correlation was not observed in a previous report (7). The difference in the transpiration rate of unfumigated plants must be partly determined by experimental conditions such as leaf angle to light and wind velocity on leaf surface as well as inherent factors such as stomatal density and physiological state of leaves.

The effect of SO<sub>2</sub> on plants should be separated into the effect of sulfite or bisulfite and that of acidity. The results of foliar application of Na<sub>2</sub>SO<sub>3</sub> and HCl shown in Fig. 3 seem to indicate that the effect of SO<sub>2</sub> fumigation on transpiration rate may be the acidic effect. To examine the effect of sulfite and acidity on stomatal aperture in detail, epidermal strips of broad bean were used. The results shown in Fig. 4 and 5 and Table 2 suggest that the ABA-dependent stomatal closure caused by SO<sub>2</sub> fumigation resulted from lowering the pH on the surface of guard cells or in the cytoplasm of guard cells. On the other hand, it has been reported that low pH of an applied medium enhances the stomatal opening (5, 12). No increase in stomatal aperture size was observed in the present experiments. It has been observed that SO<sub>2</sub> fumigation brought about stomatal opening (7, 13). This SO<sub>2</sub>-induced stomatal opening might be due to a lowering of the pH surrounding the guard cells. In the present study with no addition of ABA, sulfite application slightly increased the stomatal aperture size in the epidermal strips, which may also explain the SO<sub>2</sub>-induced stomatal opening.

Lowering the pH of the medium may lower the ABA concentration required in closing the stomata since relatively high concentrations of ABA could reduce the stomatal aperture size even in neutral region of pH. Furthermore, the rise in ABA in guard cells following the lowering of pH of the surrounding area suggests a possible mechanism of pH-dependent activation of ABA. Cultured plant cells absorbed larger amounts of indole-3-acetic acid in a low pH medium than in the neutral pH (11). To examine whether such a mechanism serves in the intact leaves or not, we must study the ABA transport in leaves.

It is known that malic acid formation plays an important role in stomatal opening (1). It was also reported that sulfite inhibited the activity of phosphoenolpyruvate (PEP) carboxylase, an important enzyme for malate formation, of corn (14) and spinach (8). Accordingly, the SO<sub>2</sub>-induced decline of transpiration rate of corn may result from the inhibition of PEP carboxylase by sulfite. It would be interesting to investigate the effect of sulfite on PEP carboxylase extracted from various plants.

#### References

1. Allaway, W.G.: Accumulation of malate in guard cells of *Vicia faba* during stomatal opening. *Planta* 110: 63-70 (1973).
2. Allaway, W. G. and T. C. Hsiao: Preparation of rolled epidermis of *Vicia faba* L. so that stomata are the only viable cells: analysis of guard cell potassium by flame photometry. *Aust. J. Biol. Sci.* 26: 309-318 (1973).
3. Bell, J. N. B. and C. H. Mudd: Sulphur dioxide resistance in plants: a case study of *Lolium perenne*. In *Effects of Air Pollutions on Plants*. Edited by T. A. Mansfield. p87-103. Cambridge University Press, 1976.
4. Bressan, R. A., L. G. Wilson and P. Fillner: Mechanisms of resistance to sulfur dioxide in the Cucurbitaceae. *Plant Physiol.* 61: 761-767 (1978).
5. Dittrich, P., M. Mayer and M. Meusel: Proton-stimulated opening of stomata in relation to chloride uptake by guard cells. *Planta* 144: 305-309 (1979).
6. Durbin, R. D. and A. Graniti: A simple technique for obtaining functionally isolated guard cells in epidermal strips of *Vicia faba*. *Planta* 126: 285-288 (1975).
7. Kondo, N. and K. Sugahara: Changes in transpiration rate of SO<sub>2</sub>-resistant and -sensitive plants with SO<sub>2</sub> fumigation and the participation of abscisic acid. *Plant & Cell Physiol.* 19: 365-373 (1978).
8. Mukerji, S. K. and S. F. Yang: Phosphoenolpyruvate carboxylase from spinach leaf tissue: inhibition by sulfite ion. *Plant Physiol.* 53: 829-834 (1974).
9. Ogawa, T., H. Ishikawa, K. Shimada and K. Shibata: Synergistic action of red and blue light and action spectra for malate formation in guard cells of *Vicia faba* L. *Planta* 14: 61-65 (1978).
10. Raschke, K.: Stomatal action. *Ann. Rev. Plant Physiol.* 26: 309-340 (1975).
11. Rubery, P. H.: Hydrogen ion dependence of carrier-mediated auxin uptake by suspension-cultured crown gall cells. *Planta* 142: 203-206 (1978).
12. Squire, G. R. and T. A. Mansfield: A simple method of isolating stomata on detached epidermis by low pH treatment: observation of the importance of the subsidiary cells. *New Phytol.* 71: 1033-1043 (1972).
13. Unsworth, M. H., P. V. Biscoe and H. R. Pinckney: Stomatal responses to sulphur dioxide. *Nature* 239: 458-459 (1972).
14. Ziegler, I.: Effects of sulphite on phosphoenolpyruvate carboxylase and malate formation in extracts of *Zea mays*. *Phytochem.* 12: 1027-1030 (1973).

## Sulfite oxidizing activities in plants

Noriaki Kondo<sup>1</sup>, Yoko Akiyama<sup>2</sup>, Makoto Fujiwara<sup>3</sup> and Kiyoshi Sugahara<sup>1</sup>

<sup>1</sup>Division of Environmental Biology, The National Institute for Environmental Studies,  
Yatabe, Ibaraki 305

<sup>2</sup>The Graduate School of Environmental Science, The University of Tsukuba,  
Sakura-mura, Ibaraki 305

<sup>3</sup>College of General Education, University of Tokyo, Meguro-ku, Tokyo 153

Sulfite oxidizing activity in plant leaves was measured by the reduction of cytochrome *c* in the presence of sulfite and by the decrease rate of sulfite exogenously applied. *Pieris japonica*, *Hydrangea paniculata*, *Enkianthus campanulatus*, castor bean and kidney bean showed high activities of cytochrome *c*-linked sulfite oxidation, while *Clethra barbinervis*, tomato, broad bean, spinach, sunflower and perilla showed a little. The activity had optimum pH between 8.0 and 8.5. The active substance was small in molecular size and not affected by either heat or trypsin treatment. The decrease rate of sulfite exogenously applied was large in extract from castor bean, and less in those from broad bean, spinach, peanut and kidney bean. The activity of tomato was especially low. On Sephadex G-25 gel filtration, the fractions with the ability to decrease sulfite was separated from those with cytochrome *c*-linked sulfite oxidizing activity. The active substances decreasing sulfite had high molecular weights. Analysis with an ion chromatograph showed that almost all sulfite was transformed to sulfate by the dialysate of castor bean extract.

The ratio of decrease in chlorophyll *a/b* ratio to sulfur increase in leaves exposed to SO<sub>2</sub> was used as an indicator of the sensitivity to SO<sub>2</sub> absorbed by plants. Castor bean was resistant to absorbed SO<sub>2</sub>, but broad bean, spinach and peanut were sensitive.

**Key words:** SO<sub>2</sub> resistance – Sulfite oxidation – Sulfur dioxide.

Chlorosis and necrosis are the typical visible symptoms produced by SO<sub>2</sub> fumigation of plants. It is known that these visible damages differ greatly in degree among plant species even under the same conditions. It has been suggested that the variability in damage depends on SO<sub>2</sub> absorption rate through the stomata (19, 20). It was recently proven that plant species which were able to decrease SO<sub>2</sub> absorption by the quick reduction of stomatal aperture on SO<sub>2</sub> fumigation were strongly resistant to the gas (11). Furthermore, the possibility has been pointed out that the resistance of plants to SO<sub>2</sub> might be controlled by biochemical factors (3). SO<sub>2</sub> absorbed by plants is transformed to sulfite ion and metabolized to cystine, glutathione, etc., and when plants were exposed to <sup>35</sup>SO<sub>2</sub> most of <sup>35</sup>S was found to exist as sulfate (22). Sulfate appears to be about thirty times less toxic to plants than sulfite (21). Recently, it was reported that the oxidation rate of sulfite added to plants is proportional to the plant resistance to sulfite ions (14).

Peroxidase (6, 10, 23), cytochrome oxidase (6) and ferredoxin-NADP reductase (15)

have been reported to be able to oxidize sulfite. Aerobic oxidation of sulfite to sulfate is also initiated by metal ions, ultraviolet irradiation, illuminated dyes as well as several enzymes (1). Furthermore, sulfite was oxidized in illuminated chloroplasts (1). It was suggested that the reaction was induced through the electron transport system in chloroplasts (1). Sulfite oxidizing activities in plant mitochondria were also reported (2, 17, 18), but the nature of the active substances has not been studied extensively. In addition, hepatic sulfite oxidase of animals and a close correlation between the sulfite oxidase activity in them and their resistance to  $\text{SO}_2$  have been also reported (4, 5).

In the present study, sulfite oxidizing activities were surveyed among several plant species. The activity catalyzing the sulfite-dependent cytochrome *c* reduction was measured spectrophotometrically, and the ability to decrease sulfite exogenously supplied was determined by the reaction of sulfite with 5,5'-dithiobis(2-nitrobenzoic acid). In addition, the relationship between these activities and the resistance of plants to  $\text{SO}_2$  was also examined.

### Materials and methods

#### Plant materials

Leaves of *Pieris japonica* D. Don, *Clethra barbinervis* Sieb. et. Zucc, *Hydrangea paniculata* Sieb. and *Enkianthus campanulatus* Nichols were collected at Owakudani in Hakone and held at  $-20^\circ\text{C}$  in a freezer until use. Peanut (*Arachis hypogaea* L. cv. Chibahandachi), tomato (*Lycopersicon esculentum* Mill cv. Fukuju No.2), sunflower (*Helianthus annuus* L. var. Russian Mammoth), perilla (*Perilla frutescens* Britt, var. Crispa Decaisne), castor bean (*Ricinus communis* L.), kidney bean (*Phaseolus vulgaris* L. cv. Shinedogawa and Master peace), and broad bean (*Vicia faba* L. cv. Otafuku) were grown at  $25 \pm 0.5^\circ\text{C}$  with a relative humidity of  $70 \pm 5\%$  in an environment-controlled glass house under natural light conditions. Spinach (*Spinacia oleracea* L. cv. Newasia) was grown at  $20 \pm 0.5^\circ\text{C}$ . Potting soil was composed of vermiculite, peat moss, perlite and fine gravel (2:2:1:1). As nutrients, 8 g/liter magnesia lime and 4 g/liter hyponex were supplied twice a week.

#### $\text{SO}_2$ fumigation

The test plants grown in the glass house were transferred to a growth cabinet (170 x 230 x 190 cm) for  $\text{SO}_2$  fumigation. The plants were preconditioned for 1 to 3 hr in the cabinet at  $25 \pm 0.5^\circ\text{C}$  ( $20 \pm 0.5^\circ\text{C}$  in the case of spinach) with a relative humidity of  $75 \pm 3\%$  under light intensity of 25,000 to 35,000 lux at leaf level. The light source was 24 metal halide lamps (400 W; Yoko Lamp, Toshiba). The  $\text{SO}_2$  concentration of 0.5 to 2.0 ppm was adjusted by diluting 6,000 ppm  $\text{SO}_2$  gas in nitrogen with air. The  $\text{SO}_2$  concentration in the cabinet rose in 5 to 10 min to the desired level, and was measured with a pulsed fluorescent  $\text{SO}_2$  analyzer (Thermo Electron Corp.). The wind velocity in the cabinet was 0.22 m/sec.

#### Sample preparation

Samples were prepared by grinding 5 g of leaves in a homogenizer for a few minutes in 45 ml of 0.1 M potassium phosphate buffer, pH 7.8, containing 0.1 mM EDTA. The filtrates obtained by filtering the homogenate through two layers of gauze were centrifuged at  $7,000 \times g$  for 10 min. The supernatants were used as the sample. All the above procedures were carried out at 0 to  $5^\circ\text{C}$ .

*Assay of sulfite oxidizing activity by means of cytochrome c reduction*

To measure sulfite oxidizing activity, the formation of reduced cytochrome *c* in open cuvettes was observed spectrophotometrically. Sample was added to cuvettes containing  $4 \times 10^{-5}$  M cytochrome *c* (Sigma),  $10^{-4}$  M EDTA and 0.1 M Tris-HCl (pH 8.5) with a final volume of 2.9 ml. The mixture was kept for 30 to 40 min at room temperature until the absorbance at 550 nm became stable, since the samples by themselves reduce cytochrome *c*. Then, 0.1 ml of  $3 \times 10^{-3}$  M sodium sulfite ( $\text{Na}_2\text{SO}_3$ ) was added and the increase in absorbance at 550 nm was followed. The activity was determined by the rate of increase in the absorbance between 0.5 and 1.5 min after the addition of  $\text{Na}_2\text{SO}_3$ . Spectrophotometric measurement was performed in a double beam spectrophotometer (200-20, Hitachi).

*Determination of sulfite with DTNB*

To know the ability of plant extracts to trap sulfite, the decrease rate of sulfite exogenously applied to the extracts was measured. Sulfite was spectrophotometrically determined after the reaction with 5,5'-dithiobis-(2-nitrobenzoic acid) (DTNB) (9). The samples were held in test tubes containing  $10^{-4}$  M  $\text{Na}_2\text{SO}_3$ ,  $10^{-4}$  M EDTA and 0.1 M Tris-HCl with a final volume of 3.0 ml at pH 8.5 at 25°C. After several minutes 1.0 ml of the mixture was placed in test tubes containing 4 ml of  $6.25 \times 10^{-5}$  M DTNB buffered by  $2.5 \times 10^{-5}$  M potassium phosphate to make pH 7.0. Absorbance at 412 nm was read for the determination. Concentrations up to  $3.5 \times 10^{-5}$  M of sulfite could be linearly determined with  $5 \times 10^{-5}$  M DTNB.

*Heat and trypsin treatments of the extracts from plant leaves*

The extracts from plant leaves were heated at 96°C for 10 min in the water bath. The heated extracts were cooled immediately in an ice bath and centrifuged at  $7,000 \times g$  for 10 min. The supernatants were used as the sample. One ml of the extracts from plant leaves was treated with 1 mg/ml of trypsin (Sigma) at 37°C for 3 hr, after which their sulfite oxidizing activities were determined.

*Gel filtration by Sephadex G-25 and -200*

The sample was prepared by homogenizing 10 g of leaves randomly excised from plants in 40 ml of 0.1 M potassium phosphate buffer, pH 7.8, containing 0.1 mM EDTA. The filtrate obtained by filtering the homogenate through two layers of gauze was centrifuged at  $7,000 \times g$  for 10 min. The supernatant was lyophilized overnight, then the obtained powder dissolved in 3 ml of 0.1 M potassium phosphate buffer, pH 6.0. This solution was applied to a column (2.2 x 32 cm or 1.9 x 44 cm) packed with Sephadex G-25 or G-200, which had been equilibrated at 5°C with 0.05 M potassium phosphate buffer, pH 6.0, and then chromatographed with the same buffer. Five ml fraction each was collected.

*Ion exchange column chromatography*

Active fractions obtained from gel filtration were combined and applied to a column (3 x 12 cm) packed with DEAE or CM cellulose, which had been equilibrated at 5°C with 0.05 or 0.005 M potassium phosphate buffer, pH 6.0. Elution was performed with a linear gradient of NaCl made up in 0.05 or 0.005 M potassium phosphate buffer, pH 6.0. The total volume of this gradient was 400 ml. Five ml fraction each was collected.

*Ion chromatography*

The products of sulfite transformed by active substances were examined with an ion

chromatograph (System 10, Dionex). Samples were held with sulfite in 1.0 mM EDTA containing buffering reagents at 25°C, then injected into the chromatograph. Elution was performed with a solution composed of 0.003 M NaHCO<sub>3</sub> and 0.0024 M Na<sub>2</sub>CO<sub>3</sub> at a flow rate of 97.5 ml/hr. Retention time of sulfite and sulfate was 13 and 17 min, respectively.

#### Determination of metals

Some metals in fractions obtained by gel filtration of leaf extract were determined with an atomic absorption spectrophotometer (170-50A, Hitachi).

#### Determination of chlorophyll a and b

Test plants were fumigated with 0.5 to 1.5 ppm SO<sub>2</sub> for 3 hr, and kept in the light for additional 6 hr. Twenty to 25 leaf discs 1.5 cm in diameter excised from leaves were homogenized with a Polytron (PT10/35, Kinemática) in 80% acetone. In the case of Fig. 10, spinach plants were exposed to 2.0 ppm SO<sub>2</sub> continuously, and 10 discs were excised at 1.5 hr interval from the start of the exposure. The homogenate was used for spectrophotometric determination of chlorophyll *a* and *b* by the method of Mackinney (13).

#### Determination of sulfur content in leaves

The test plants were exposed to 0.5 to 1.5 ppm SO<sub>2</sub> for 3 hr. All leaves were snipped off immediately after the exposure, dried at 70°C for several days and ground with a mortar and pestle to powder. Sulfur content of the powder was determined with a fluorescent X-ray analyzer (D-9C, Rigaku Corp.).

## Results

#### Cytochrome *c* reduction by sulfite catalyzed by plant extracts

The sulfite oxidizing activity in plant extracts was determined by means of

Table 1 Activity catalyzing cytochrome *c* reduction caused by sulfite

	10 <sup>3</sup> ΔA <sub>550</sub> /min/mg fr.wt	
	Exp. 1 <sup>a</sup>	Exp. 2 <sup>b</sup>
<i>Pteris japonica</i>	36.0	67.0
<i>Clethra barbinervis</i>	1.0	
<i>Hydrangea paniculata</i>	12.0	
<i>Enkianthus campanulatus</i>	11.5	
Tomato	1.5	1.0
Broad bean		0.0
Spinach	1.1	
Sunflower	1.4	
Perilla		0.2
Peanut		1.6
Castor bean		12.0
Kidney bean		15.2

<sup>a</sup> Sulfite concentration, 10 μM

<sup>b</sup> Sulfite concentration, 100 μM

## Sulfite oxidizing activities in plants

cytochrome *c* reduction, and shown in Table 1. *Pieris japonica*, *Hydrangea paniculata* and *Enkianthus campanulatus* which were collected at Owakudani showed the highest activity. Castor bean and kidney bean grown in the glass house also showed high activity. *Clethra barbinervis*, tomato, spinach, sunflower, perilla, peanut and broad bean exhibited little activity.

### *Decrease in sulfite exogenously applied to plant extracts*

The ability of plant extracts to trap exogenous sulfite was examined. The time course of the decrease in sulfite exogenously applied to kidney bean extract is shown in Fig. 1. Sulfite decreased almost linearly with reaction time. To calculate the rate of decrease in sulfite, the difference in the content between 10 and 30 min after the addition of sulfite to the reaction mixture was used. The rate of decrease in sulfite and that of reduction of cytochrome *c* were compared (Table 2). The ability to decrease sulfite was large in castor bean, and less in tomato, spinach, peanut, kidney bean and broad bean. Both the activities in tomato, spinach and broad bean were low, while those in castor bean were

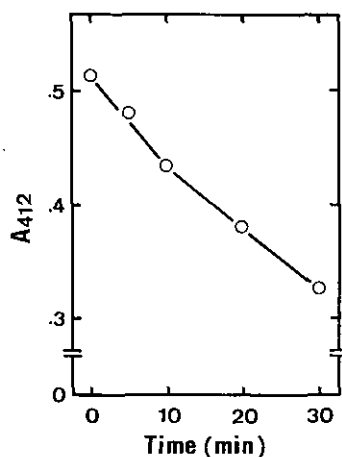

Fig. 1. *Decrease in sulfite exogenously applied to kidney bean extract.* The extract from kidney bean of 0.5 ml was held in a test tube containing reaction mixture with a final volume of 3.0 ml at room temperature. After the various time intervals, 1.0 ml of the reaction mixture was placed in a test tube containing 4.0 ml of buffer with DTNB and the absorbance at 412 nm was read in a spectrophotometer.

Table 2 *The comparison between cytochrome c-linked sulfite oxidizing activity and the ability to decrease exogenous sulfite in the extract from test plants*

	Cyt <i>c</i> reduced (n moles/min/mg fr.wt)	Sulfite decreased
Tomato	0.11	0.002
Broad bean	0.00	0.014
Spinach	0.00	0.020
Peanut	0.56	0.024
Castor bean	0.88	0.041
Kidney bean	1.16	0.027

high. However, the decrease rates were not necessarily parallel to the cytochrome *c*-linked sulfite oxidizing activities.

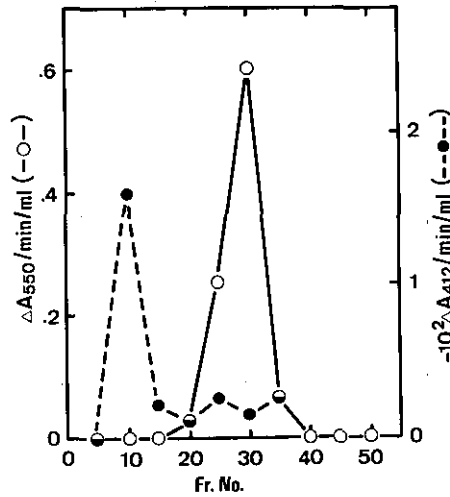

Fig. 2. Gel filtration of the substances with sulfite oxidizing activities. The extract from castor bean leaves was applied to a Sephadex G-25 column (2.2 × 32 cm) and 5 ml fraction each was collected. Cytochrome *c*-linked sulfite oxidizing activity (—○—) and the ability to decrease sulfite exogenously applied (---●---) were determined.

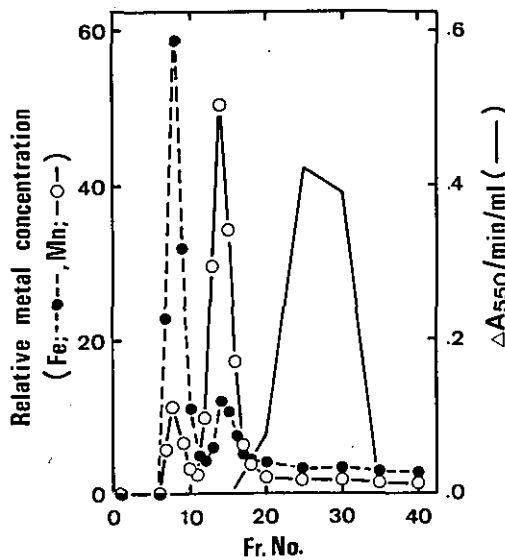

Fig. 3. Determination of heavy metals in the fractions obtained by gel filtration using Sephadex G-25. The concentrations of Fe (---●---) and Mn (-○-) were determined with an atomic absorption spectrophotometer. Cytochrome *c*-linked sulfite oxidizing activity (—) was also determined.



*Gel filtration of the substances with sulfite oxidizing activity*

When the extract from castor bean was fractionated with Sephadex G-25, the fractions with the ability to decrease sulfite were separated from those with cytochrome *c*-linked sulfite oxidizing activity (Fig. 2). The former fractions were located in void volume, the region with high molecular weight, and the substance in the latter was small in molecular size. Some metals in each fraction were determined with an atomic absorption spectrophotometer. Filtration patterns of Mn and Fe are shown in Fig. 3. A large peak of Fe and a small peak of Mn occurred in void volume. Neither of these metals was found in the fractions with cytochrome *c*-linked sulfite oxidizing activity. Manganese, Cu, Co and Mo were also sought in the latter fractions but were not found (data not shown).

*Biochemical properties of the substances with sulfite oxidizing activity*

The activity catalyzing the sulfite-dependent cytochrome *c* reduction in kidney bean had optimum pH between 8.0 and 8.5 (Fig. 4). The extracts from some other plants also showed the same pH optimum (data not shown). Neither heat nor trypsin treatment affected the activity (Table 3). The active substance was eluted by about 0.85 M NaCl on DEAE cellulose column chromatography (Fig. 5), and not trapped by CM cellulose. The substance by itself could reduce cytochrome *c* without sulfite, and sulfite enhanced the cytochrome *c* reduction (Fig. 6). The rate of cytochrome reduction promoted by sulfite declined gradually, and the decreased rate was not restored by an another addition of sulfite or cytochrome *c*.

The substances with the ability to decrease exogenous sulfite was fractionated by Sephadex G-200 gel filtration, and separated into two peaks (Fig. 7). One peak which was smaller in molecular size than the other in void volume showed most of the activity.

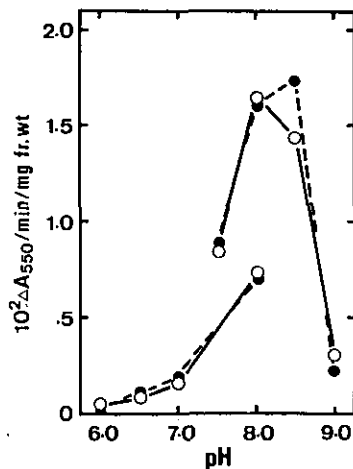

Fig. 4. pH Dependence of cytochrome *c*-linked sulfite oxidizing activity. The extracts from two cultivars (Shinedogawa; —○— and Master peace; —●—) of kidney bean, 0.05 ml each, was added to reaction mixture. The pH was adjusted with 0.1 M potassium phosphate (pH 6.0 to 8.0) and with 0.1 M Tris-HCl (pH 7.5 to 9.0).

Table 3 *Effect of heat and trypsin treatments on cytochrome c-linked sulfite oxidizing activity*

	$10^3 \Delta A_{550}/\text{min}/\text{mg fr. wt}$			
	Heat treatment (min)		Trypsin treatment (hr)	
	0	10	0	3
Kidney bean				
Shin-edogawa	14.4	14.4	8.9	8.3
Master peace	17.4	11.0	—	—
Castor bean	9.8	9.3	10.0	8.2

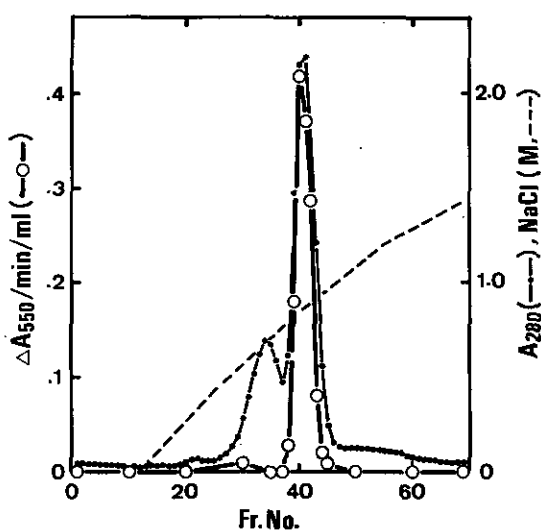

Fig. 5. Ion exchange column chromatography of cytochrome c-linked sulfite oxidizing activity. Acetone extract from 10 g of castor bean leaves was centrifuged, concentrated to remove acetone, loaded on a column packed with DEAE cellulose, and then eluted by a gradient of NaCl in 0.05 M potassium phosphate buffer, pH 6.0.

Table 4 *Effect of heat and trypsin treatments on the activity to decrease sulfite*

	Treatment period	$-10^2 \Delta A_{412}/\text{min}/\text{mg fr. wt}$
Heat treatment	0	1.45
	20 min	0.00
Trypsin treatment	0	1.93
	3 hr	1.70

The former fractions were combined and loaded on the column packed with CM cellulose. A linear gradient of NaCl in 0.005 M potassium phosphate buffer, pH 6.0, was applied. The active substance was eluted at 0.1 M NaCl (Fig. 8), and not trapped by DEAE cellulose. The substance obtained by gel filtration was subjected to heat and

trypsin treatments. The activity was resistant to trypsin but sensitive to heat treatment (Table 4).

*Identification of the product transformed from sulfite by the substance with ability to decrease sulfite*

About 10 g of castor bean leaves were excised, homogenized and centrifuged. After

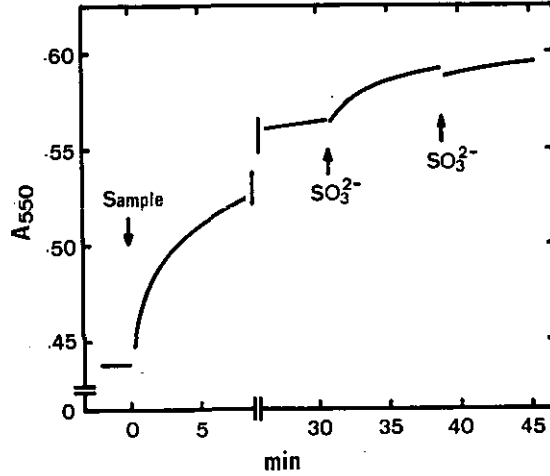

Fig. 6. Time course of cytochrome *c* reduction induced by the active substance and enhanced by sulfite. Fractions with cytochrome *c*-linked sulfite oxidizing activity on DEAE cellulose column chromatography (Fig. 5) were combined and concentrated to 10 ml. Fifty  $\mu$ l of the sample was added to 2.85 ml of reaction mixture at 0 time, and 0.1 ml of 3 mM sulfite added to the mixture at 31 min followed by another addition of sulfite at 39 min.

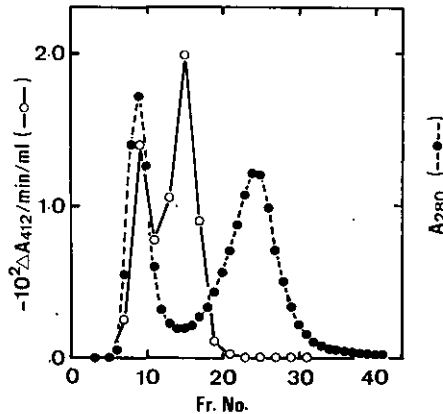

Fig. 7. Gel filtration of the substances able to decrease sulfite. Extract from 5 g of castor bean leaves was loaded on a Sephadex G-200 column (1.9  $\times$  44 cm). Five ml fraction each was collected and assayed.

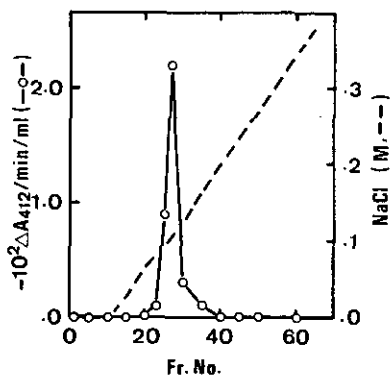

Fig. 8. Ion exchange column chromatography of the substances able to decrease sulfite. Fractions of No.13 to 18 in Fig. 7 were combined and loaded on a CM cellulose column. Elution was performed with a linear gradient of NaCl made up in 0.005 M potassium phosphate buffer, pH 6.0.

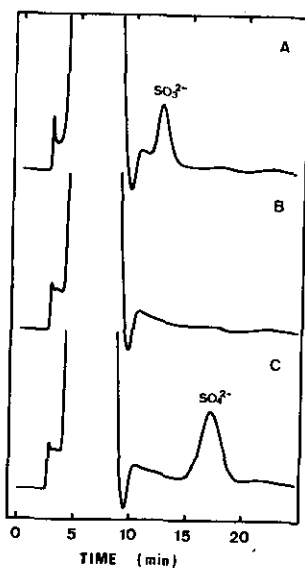

Fig. 9. Ion chromatography of sulfite (A) and the products (C) transformed from sulfite by the substances able to decrease sulfite. Extract from 10 g of castor bean leaves was lyophilized and dialyzed against 0.005M potassium phosphate buffer, pH 6.0. Dialysate was made up to 10 ml with same buffer. Three ml of 0.1 M Tris-HCl buffer, pH 8.5, contained 0.3 mM  $\text{Na}_2\text{SO}_3$  and 0.2 ml of sample was held at 25°C for 35 min, and then injected into an ion chromatography. Middle line (B) represents the chart obtained by the mixture containing sample but not sulfite.

centrifugation, the supernatant was lyophilized and dialyzed against 0.005 M potassium phosphate buffer, pH 6.0. Dialysate was made up to 10 ml with 0.005 M potassium phosphate buffer, pH 6.0, and used as sample. Solution of 3 ml of 0.1 M Tris-HCl buffer, pH 8.5, containing 0.3 mM  $\text{Na}_2\text{SO}_3$  and 0.2 ml sample was held at 25°C for 35 min, then

Sulfite oxidizing activities in plants

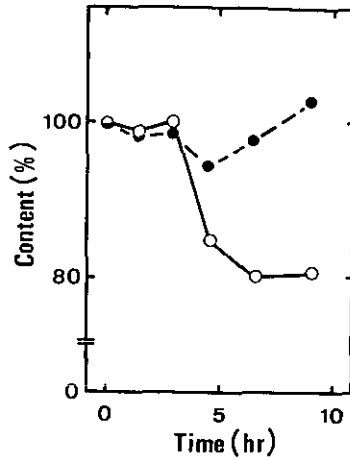

Fig. 10. Changes in chlorophyll a and b contents caused by  $SO_2$  fumigation. Spinach plants were exposed continuously to 2.0 ppm  $SO_2$ . Ten discs excised from the leaves were collected at 1.5 hr intervals.

Table 5 Increase in sulfur content and change in chlorophyll a/b ratio in plant leaves exposed to  $SO_2$ .

	$SO_2$ conc (ppm)	Sulfur cont. (mgS/g d.w.)	Increase in sulfur (mgS/g d.w.)	Chl a/b ratio	% decrease in ratio	% decrease in ratio sulfur increase
Tomato	0.0	$19.09 \pm 0.47^a$		$3.13 \pm 0.02$		(5) <sup>b</sup>
	1.0	$20.51 \pm 0.88$	1.43	$3.05 \pm 0.07$	2.6	1.9 (5)
Broad bean	0.0	$3.74 \pm 0.17$		$3.14 \pm 0.05$		(5)
	1.0	$5.38 \pm 0.30$	1.64	$2.68 \pm 0.06$	14.4	8.8 (5)
Spinach	0.0	$6.11 \pm 0.10$		$3.37 \pm 0.04$		(6)
	1.0	$8.45 \pm 0.18$	2.34	$2.95 \pm 0.04$	12.5	5.3 (6)
Peanut	0.0	$4.26 \pm 0.04$		$3.70 \pm 0.04$		(6)
	1.5	$4.98 \pm 0.02$	0.72	$3.49 \pm 0.05$	5.6	7.7 (6)
Castor bean	0.0	$11.66 \pm 0.27$		$3.60 \pm 0.06$		(5)
	0.5	$15.85 \pm 0.29$	4.20	$3.70 \pm 0.07$	-2.8	-0.7 (5)
Kidney bean	0.0	$3.12 \pm 0.04$		$3.40 \pm 0.02$		(5)
	1.0	$6.22 \pm 0.07$	3.10	$3.07 \pm 0.04$	9.6	3.1 (5)

<sup>a</sup> Standard error

<sup>b</sup> Figures in parentheses representing the number of plants used.

injected into an ion chromatograph. Fig. 9 shows that almost all sulfite was transformed to sulfate.

*Estimation of plant resistance to absorbed  $SO_2$*

To know what roles biochemical factors play in the mechanism of  $SO_2$  resistance in plants, some quantitative measure of plant damage is required. When the leaves were exposed to  $SO_2$  in the light, chlorophyll a degraded more easily than chlorophyll b

(Fig. 10). Thus, the ratio of chlorophyll *a* to *b* (chl *a/b* ratio) decreased following an increase in plant damage. The damage depends on the rate of SO<sub>2</sub> absorption which is controlled by the density and size of the stomata. Therefore, to investigate the biochemical mechanisms of SO<sub>2</sub> resistance the damage by SO<sub>2</sub> must be corrected on the basis of the amount of SO<sub>2</sub> absorbed. The ratio of decrease in chl *a/b* ratio to increase in sulfur content due to SO<sub>2</sub> absorption was tested as an indicator of the resistance to SO<sub>2</sub> absorbed by plants. Castor bean was resistant to absorbed SO<sub>2</sub>, while spinach, broad bean and peanut were sensitive (Table 5). Except for peanut which absorbed only a little SO<sub>2</sub>, these results generally seem to agree with the visible symptoms.

### Discussion

A substance with cytochrome-linked sulfite oxidizing activity was found in various plant species. From Fig. 2 and Table 3, it was proven that this substance is small in molecular size and unlikely to be proteinaceous. The partially purified substance by itself reduced cytochrome *c* without sulfite and sulfite enhanced the cytochrome reduction driven by this substance (Fig. 6). This stimulative effect of sulfite seems to be limited. How sulfite affects the action of the substance must await further studies. A cytochrome *c* reducing substance (CRS) in plants was already reported (7, 8). CRS has a relatively high molecular weight and CRS could not be easily extracted by buffer. Therefore, the present substance seems to be different from CRS. Substances with high molecular weight catalyzing sulfite oxidation were also found in the present study and were separated into two peaks on gel filtration using Sephadex G-200. The substance with lower molecular weight was sensitive to heat treatment. These substances could not reduce cytochrome *c* during sulfite oxidation, although sulfite oxidase in animals reduced cytochrome *c* with sulfite oxidation. Sulfite oxidation due to peroxidase, cytochrome oxidase and ferredoxin-NADP reductase required Mn<sup>2+</sup>, ferrocyanide and NADP, respectively. However, the present substances did not require any addition to the reaction mixture for sulfite oxidation. Therefore, the present substances seem to be different from substances previously reported. However, whether the active substances have peroxidase or cytochrome oxidase activity or not is not known yet.

The methods described below have been sometimes used for the estimation of the damage caused by air pollutants.

1) The measurement of a leaf area exhibiting chlorosis and necrosis per whole leaf area (3).

2) The decrease in chlorophyll content per fresh or dry weight or per leaf area (12). These methods exhibited some disadvantages in the present study. For example, pronounced shrinkage of plant leaves, especially broad bean leaves, occurred with SO<sub>2</sub> fumigation, and both the fresh and dry weights of plant leaves decreased with SO<sub>2</sub> fumigation in almost all plant species used. Thus, these methods were not applicable to the present study. It has been reported that chl *a/b* ratio in leaves decreased with O<sub>3</sub> injury (12). In the present experiments, SO<sub>2</sub> fumigation also caused a decrease in the ratio, suggesting that the chl *a/b* ratio may be a convenient evaluation of plant damage caused by air pollutants. In our experiments, castor bean had highest resistance to absorbed SO<sub>2</sub> as measured by the chl *a/b* ratio. With the exception of tomatoes this ability to decrease sulfite and resistance to absorbed SO<sub>2</sub> showed generally parallel relationships (Table 5). It was suggested that chlorophyll destruction caused by SO<sub>2</sub> was due to O<sub>2</sub><sup>-</sup> production by the reaction of sulfite with chlorophyll under illumination

(16). In addition, it was also reported that chlorophyll *a* was more sensitive to  $O_2^-$  than chlorophyll *b* (16). Accordingly, the measurement of chl *a/b* ratio seems to be a useful means for the evaluation of plant damage caused by  $SO_2$ . However, the practical use of this method must await further extensive investigations.

Sulfite is very reactive; it generates free radicals following reactions with some enzymes, metals, chlorophyll, etc., resulting in sulfite oxidation. The ability to decrease exogenous sulfite, which was shown in Fig. 2, may include at least one of these reactions. Damage to plants may occur during these reaction processes. In the present study, however, the sulfite oxidizing activity seems likely to play an important role in detoxication of sulfite, since castor bean having the capacity to oxidize sulfite was strongly resistant to absorbed  $SO_2$ . High activity catalyzing the sulfite-dependent cytochrome *c* reduction was found in plants grown in Owakudani where plants were exposed to volcanic smoke containing high concentrations of  $H_2S$  and  $SO_2$ . Therefore, this activity may also participate largely in detoxication of sulfite. The identification of the substance, however, remains to be studied.

The calculations from Tables 2 and 5 with an assumption that the ratio of fresh to dry weight of leaves is 6 showed that half of  $SO_2$  absorbed by plant leaves could be oxidized by the activity to decrease sulfite. Soybean converted sulfite at the rate of ca. 50  $\mu gSO_2/g/min$  (14), whereas the present substances with high and low molecular weights in castor bean could oxidize sulfite only at the rate of 2.6 and 28  $\mu gSO_2/g/min$ , respectively, even if these activities functioned in intact plant leaves. Therefore, a participation of electron transport system in chloroplasts seems to be also important in sulfite oxidation.

#### References

1. Asada, K. and K. Kiso: Initiation of aerobic oxidation of sulfite by illuminated spinach chloroplasts. *Eur. J. Biochem.* 33: 253-257 (1973).
2. Ballantyne, D. J.: Sulphite oxidation by mitochondria from green and etiolated peas. *Phytochem.* 16: 49-50 (1977).
3. Bressan, R. A., L. G. Wilson and P. Fillner: Mechanisms of resistance to sulfur dioxide in the Cucurbitaceae. *Plant Physiol.* 61: 761-767 (1978).
4. Cohen, H. J., S. Betchen-Lange, D. L. Kessler and K. V. Rajagopalan: Hepatic sulfite oxidase. Congruency in mitochondria of prosthetic groups and activity. *J. Biol. Chem.* 247: 7759-7766 (1972).
5. Cohen, H. J., R. T. Drew, J. L. Johnson and K. V. Rajagopalan: Molecular basis of the biological function of molybdenum. The relationship between sulfite oxidase and the acute toxicity of bisulfite and  $SO_2$ . *Proc. Nat. Acad. Sci. USA* 70: 3655-3659 (1973).
6. Fridovich, I. and P. Handler: Detection of free radicals generated during enzymic oxidations by the initiation of sulfite oxidation. *J. Biol. Chem.* 236: 1836-1840 (1961).
7. Fujita, Y. and J. Meyers: Cytochrome *c* redox reactions induced by photochemical system 1 in sonicated preparations of *Anabaena cylindrica*. *Arch. Biochem. Biophys.* 113: 730-737 (1966).
8. Fujita, Y. and J. Meyers: Some properties of the cytochrome *c* reducing substance, a factor for light-induced redox reaction of cytochrome *c* in photosynthetic lamellae. *Plant & Cell Physiol.* 7: 599-606 (1966).
9. Humphrey, R. E., M. H. Ward and W. Hinze: Spectrophotometric determination of sulfite with 4,4'-dithiodipyridine and 5,5'-dithiobis-(2-nitrobenzoic acid). *Analyt. Chem.* 42: 698-702 (1970).
10. Klebanoff, S. J.: The sulfite-activated oxidation of reduced pyridine nucleotides by peroxidase. *Arch. Biochem. Biophys.* 122: 481-487 (1961).
11. Kondo, N. and K. Sugahara: Changes in transpiration rate of  $SO_2$ -resistant and -sensitive plants with  $SO_2$  fumigation and the participation of abscisic acid. *Plant & Cell Physiol.* 19: 365-373 (1978).

12. Kundson, L. L., T. W. Tibbitts and G. E. Edwards: Measurement of ozone injury by determination of leaf chlorophyll concentration. *Plant Physiol.* 60: 606-608 (1977).
13. Mackinney, G.: Absorption of light by chlorophyll solutions. *J. Biol. Chem.* 140: 315-322 (1941).
14. Miller, J. E. and P. B. Xerikos: Residence time of sulphite in SO<sub>2</sub> 'sensitive' and 'tolerant' soybean cultivars. *Environ. Pollut.* 18: 259-264 (1979).
15. Nakamura, S.: Initiation of sulfite oxidation by spinach ferredoxin-NADP reductase and ferredoxin system: a model experiment on the superoxide anion radical production by metalloflavoproteins. *Biochem. Biophys. Res. Comm.* 41: 177-183 (1970).
16. Peiser, G. O. and S. F. Yang: Chlorophyll destruction by the bisulfite-oxygen system. *Plant Physiol.* 60: 277-281 (1977).
17. Tager, J. M. and N. Rautanen: Sulfite oxidation by plant mitochondrial system. Preliminary observations. *Biochem. Biophys. Acta* 18: 111-121 (1955).
18. Tager, J. M. and N. Rautanen: Sulphite oxidation by plant mitochondrial system. Enzymic and non-enzymic oxidation. *Physiol. Plant.* 9: 665-673 (1956).
19. Taylor, O. C.: Acute responses of plants to aerial pollutants. In *Air Pollution Damage to Vegetation*. Edited by J. A. Naegele, p.9-20. American Chemical Society, Washington, D. C., 1973.
20. Thomas, M. D.: Effects of air pollution on plants. In *Air Pollution*. p.233-278. World Health Organisation, Geneva, 1961.
21. Thomas, M. D., R. H. Hendricks, T. R. Collier and G. R. Hill: The utilization of sulfate and sulfur dioxide for the nutrition of alfalfa. *Plant Physiol.* 18: 345-371 (1943).
22. Weigal, J. and H. Ziegler: Die Raumlische Verteilung von <sup>35</sup>S und die Art der Markierten Verbindungen in Spinatblättern nach Begasung mit <sup>35</sup>SO<sub>2</sub>. *Planta* 58: 435-447 (1962).
23. Yang, S. F.: Biosynthesis of ethylene. Ethylene formation from methional by horseradish peroxidase. *Arch. Biochem. Biophys.* 122: 481-487 (1967).



## Resistance of spruce seedlings to sulfur dioxide fumigation

Tatsuo Oku<sup>1</sup>, Ken-ichiro Shimazaki<sup>2</sup> and Kiyoshi Sugahara<sup>2</sup>

<sup>1</sup>Department of Forestry, Faculty of Agriculture, Kyushu University, Fukuoka 812

<sup>2</sup>Division of Environmental Biology, The National Institute for Environmental Studies,  
Yatabe, Ibaraki 305

Spruce seedlings were highly resistant to SO<sub>2</sub> injury when exposed to the gas. The O<sub>2</sub> evolution associated with CO<sub>2</sub> fixation in the presence of bicarbonate slightly decreased after exposure to 2 ppm SO<sub>2</sub> for 24 hr. Injurious symptoms such as chlorosis and glazing of the leaf surface were not detected on the cotyledons. When bisulfite at high concentration was added to the reaction medium, slight inhibition of O<sub>2</sub> evolution was observed. On the other hand, SO<sub>2</sub> fumigation to lettuce plants at 2 ppm for 1 hr markedly caused a decrease in O<sub>2</sub> evolution.

Key words: Air pollution – Bisulfite ions – Effect of SO<sub>2</sub> – Resistance to SO<sub>2</sub> – Spruce seedlings – Sulfur dioxide

The absorption of atmospheric SO<sub>2</sub> through the stomata injures plants as characterized by visible symptoms on the leaves. Primary SO<sub>2</sub> injury is characterized by a destruction of cellular integrity and damage to the guard and spongy parenchyma cells. The degree of SO<sub>2</sub> injury does not depend on the stomatal aperture but on the rate of SO<sub>2</sub> absorption (1, 10). Some plants such as tomato and peanut have resistance to SO<sub>2</sub> injury (2). Kondo and Sugahara (2) showed that stomatal closing was controlled by the action of abscisic acid in the leaves. Furthermore, they suggested that the resistance was associated with a bisulfite-oxidizing substance in SO<sub>2</sub>-fumigated leaves (3). Thus, two requirements for SO<sub>2</sub> resistibility of higher plants may be a rapid response of the stomata and a biochemical oxidation of the incorporated SO<sub>2</sub> to a non-toxic substance.

Few investigations have been reported on the biochemical effects of SO<sub>2</sub> fumigation on coniferous vegetation except for the papers of Malhotra and his co-worker (4, 5). The present preliminary note reports the resistance of spruce seedlings to SO<sub>2</sub> fumigation. The resistibility is discussed in relation to further investigation.

### Materials and methods

Spruce (*Picea abies*) seedlings were grown on vermiculite in the dark at 27°C for two weeks, then under natural light for one week. The seedlings were exposed to SO<sub>2</sub> gas at 2.0 ppm for indicated time periods. The fumigation system was the same as described by Shimazaki and Sugahara (8).

The rate of O<sub>2</sub> evolution associated with CO<sub>2</sub> fixation in the presence of bicarbonate was measured with an oxygen electrode (YSI Co., Model 4004) at 25°C (6). Eighteen pieces of cotyledons cut off from the top of the hypocotyls were attached to a plastic

frame (4.0 cm × 3.5 cm) in a single layer. The frame was placed in the reaction cuvette containing 27 ml of 50 mM HEPES (pH 7.2) and 30 mM bicarbonate. Actinic light at intensity of  $2 \cdot 10^5$  ergs·cm<sup>-2</sup>·sec<sup>-1</sup> was provided from a 300 W tungsten lamp after passing through a 1% CuSO<sub>4</sub> solution (5 cm pathlength).

The preparation of chloroplasts from cotyledons and the measurement of O<sub>2</sub> evolution by isolated chloroplasts were performed according to the method of Oku and Tomita (7).

### Results and discussion

The effect of SO<sub>2</sub> gas on photosynthetic O<sub>2</sub> evolution in spruce cotyledons is shown in Fig. 1A. The rate of O<sub>2</sub> evolution remained unchanged for cotyledons exposed to 2 ppm SO<sub>2</sub> for 1-6 hr relative to the control sample (Curve 1). Prolonged exposure of cotyledons for 24 hr caused a slight reduction in the O<sub>2</sub> evolution (Curve 2). The O<sub>2</sub> uptake for respiration in the dark was not affected by SO<sub>2</sub> exposure. These results

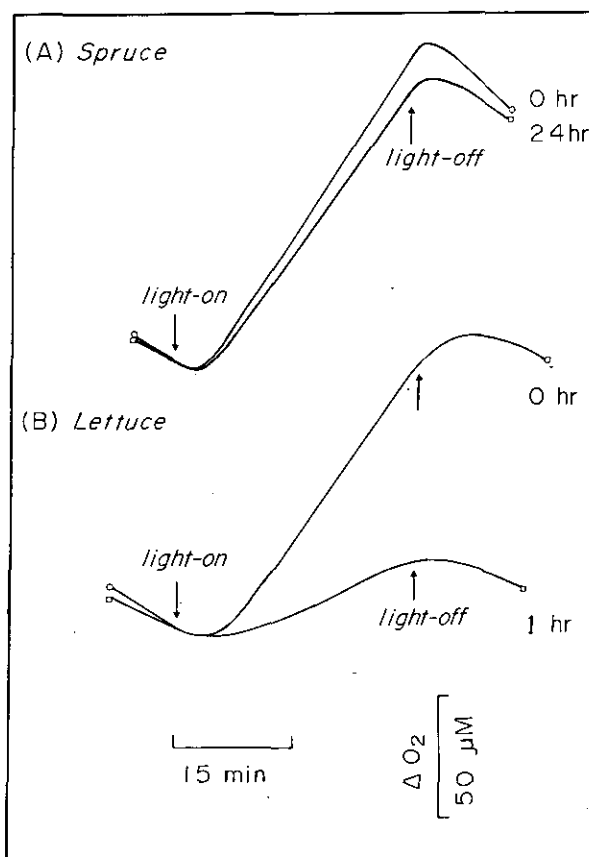

Fig. 1. Effect of SO<sub>2</sub> gas on the O<sub>2</sub> evolution in spruce cotyledons (A) and lettuce leaves (B). Exposure to 2 ppm SO<sub>2</sub> was performed for 24 hr towards spruce and for 2 hr towards lettuce. Curve 1, non-exposed; Curve 2, exposed leaves. The O<sub>2</sub> evolution rate in Curve 1 was about 65 μmoles/mg chlorophyll·hr.

## Resistance of spruce seedlings to SO<sub>2</sub>

indicate that spruce seedlings were highly resistant to SO<sub>2</sub> fumigation. On the other hand, lettuce leaves were markedly susceptible to SO<sub>2</sub> as shown in Fig. 1B. The O<sub>2</sub> evolution rate was reduced to about 30% of the control after exposure to 2 ppm for 1 hr (Curve 2). These leaves sometimes showed indications of initial visible injury as characterized by glazing of leaf surface.

A primary determinant for SO<sub>2</sub> injury may be the rate of SO<sub>2</sub> absorption through the stomata (1, 2). Therefore, the above observation on the SO<sub>2</sub> resistance of cotyledons suggests that the stomata remain tightly closed during SO<sub>2</sub> exposure, but conflicting this, they are open during measurement of O<sub>2</sub> evolution. To resolve this question, sodium bisulfite was added to the reaction medium. If the stomata partly opened, then the bisulfite ions added may diffuse into the leaf tissue and caused inhibition of O<sub>2</sub> evolution. Cotyledons were preilluminated for more than 60 min with light (10<sup>5</sup> ergs·cm<sup>-2</sup>·sec<sup>-1</sup>) to let the stomata open, then placed in the reaction medium containing bisulfite immediately after harvesting. After incubation of the cotyledons in the dark or light for 20 min, and the addition of bicarbonate, O<sub>2</sub> evolution was started by illumination. The result obtained is shown in Fig. 2. The steep O<sub>2</sub> uptake in the dark was observed in the presence of bisulfite (Curve 2 and 3). Therefore, the O<sub>2</sub> evolution rate was estimated after correction for the drift of the base line due to added bisulfite. The corrected value showed that O<sub>2</sub> evolution was not inhibited by 10 mM bisulfite (Curve 2). The addition of bisulfite at the higher concentration of 50 mM inhibited O<sub>2</sub> evolution by only 5 % relative to the control (Curve 3). This suggests that stomata are not close in the presence of bisulfite because bicarbonate ions were taken up into leaf tissue in this condition.

On the other hand, cotyledons cut into small pieces were infiltrated with the sulfite

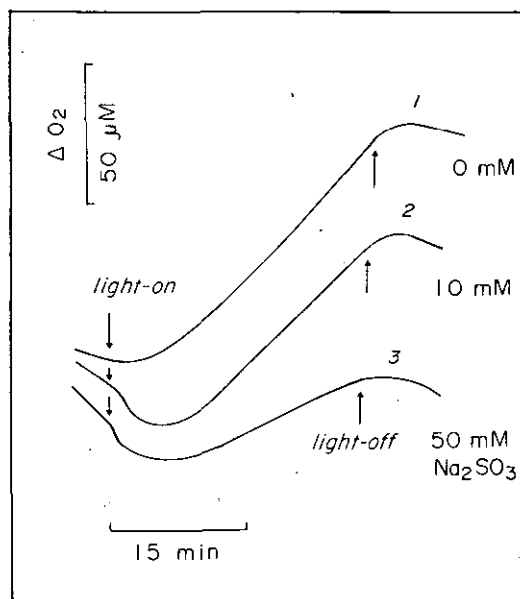

Fig. 2. Effect of bisulfite ions on the O<sub>2</sub> evolution in spruce cotyledons. The cotyledons were incubated in the HEPES buffer containing bisulfite at indicated concentrations for 20 min in the dark, then measured for O<sub>2</sub>-evolving activity. Curve 1, control; Curve 2, 10 mM Na<sub>2</sub>SO<sub>3</sub>; Curve 3, 50 mM Na<sub>2</sub>SO<sub>3</sub>.

Table 1  $O_2$  evolution by chloroplasts from bisulfite-infiltrated cotyledons

Cotyledon treatment	$O_2$ evolution ( $\mu\text{moles/mg chl}\cdot\text{hr}$ )
Control	61.4
20 mM bisulfite	47.6
40 mM bisulfite	50.5
20 mM bisulfite – illumination	47.4

The bisulfite solution at indicated concentrations was infiltrated into cotyledons under vacuum for 10 min. In some experiments cotyledons were further illuminated with white light ( $10^5 \text{ ergs}\cdot\text{cm}^{-2}\cdot\text{sec}^{-1}$ )

solution under vacuum, then homogenized after illumination with white light. The  $O_2$  evolution by chloroplasts prepared from these cotyledon segments is shown in Table 1. The chloroplasts showed only an inhibition of 23 % relative to the control for the  $O_2$  evolution. Shimazaki et al. (9) showed that the  $SO_2$  injury proceeded under illumination. The accelerated inhibition due to illumination was, however, not observed in this experiment. Thus, for the results obtained we can presume that the  $SO_2$  resistibility of spruce seedlings does not result from the rapid stomatal response but from the capacity for guard and parenchyma cells to oxidize absorbed  $SO_2$  (bisulfite). The data of Kondo et al. (3) support this possibility: they showed that  $SO_2$  resistant plants retained the high activity of sulfite oxidation. When bisulfite ions were removed from the reaction medium, the slight inhibition found for Curve 3 of Fig. 2 disappeared completely (data not shown). This recovery of  $O_2$  evolution is probably due to the rapid detoxification of incorporated bisulfite ions.

In conclusion, the strong resistibility of spruce seedlings to  $SO_2$  fumigation seems to result mainly from some biochemical oxidation of absorbed  $SO_2$  (bisulfite) but also from rapid stomatal closing. The detailed mechanism for the resistance to  $SO_2$  fumigation must wait further investigation.

#### References

1. Bressan, A. R., L. G. Wilson and P. Filner: Mechanism of resistance to sulfur dioxide in the *Cucurbitaceae*. *Plant Physiol.* 61: 761-767 (1978).
2. Kondo, N. and K. Sugahara: Changes in transpiration rate of  $SO_2$ -resistant and -sensitive plants with  $SO_2$  fumigation and the participation of abscisic acid. *Plant & Cell Physiol.* 19: 365-373 (1978).
3. Kondo, N., Y. Akiyama, M. Fujiwara and K. Sugahara: Sulfite oxidizing activities in plants. In *this Research Report*.
4. Malhotra, S. S.: Effects of sulphur dioxide on biochemical activity and ultrastructural organization of pine needle chloroplasts. *New Phytol.* 76: 239-245 (1976).
5. Malhotra, S. S. and A. A. Kahn: Effects of sulphur dioxide fumigation on lipid biosynthesis in pine needles. *Phytochemistry* 17: 241-244 (1978).
6. Oku, T., K. Sugahara and G. Tomita: Photosynthetic  $CO_2$ -fixing activity in dark-grown spruce seedlings. *Plant & Cell Physiol.* 20: 857-859 (1979).
7. Oku, T. and G. Tomita: Photoactivation of latent  $O_2$ -evolving center in chloroplasts isolated from dark-grown spruce seedlings. *Physiol. Plant.*, in press.
8. Shimazaki, K. and K. Sugahara: Specific inhibition of photosystem II activity in chloroplasts by fumigation of spinach leaves with  $SO_2$ . *Plant & Cell Physiol.* 20: 947-955. (1979).
9. Shimazaki, K., T. Sakaki and K. Sugahara: Active oxygen participation in chlorophyll destruction and lipid peroxidation in  $SO_2$ -fumigated leaves of spinach. In *this Research Report*.
10. Thomas, M. D.: Effects of air pollution on Plants. *Monogr. Ser. WHO* 46: 233-277 (1961).

## Role of superoxide dismutase in the defense against SO<sub>2</sub> toxicity and induction of superoxide dismutase with SO<sub>2</sub> fumigation

Kiyoshi Tanaka and Kiyoshi Sugahara

Division of Environmental Biology, The National Institute for Environmental Studies,  
Yatabe, Ibaraki 305

The role of superoxide dismutase (SOD), catalyzing the disproportionation of the superoxide radicals to hydrogen peroxide and oxygen ( $O_2^- + O_2^- + 2H^+ \rightarrow O_2 + H_2O_2$ ), in the defense against sulfur dioxide (SO<sub>2</sub>) toxicity was investigated using leaves of poplar and spinach plants. Young poplar leaves were more resistant to the toxicity of 2.0 ppm SO<sub>2</sub> than the old ones were. Young poplar leaves contained approximately five times more SOD than old leaves did. Spraying spinach leaves with diethyldithiocarbamate (DDTC) caused a marked loss of SOD activity in leaves which resulted in a decrease in their resistance to the toxic effects of 0.5 ppm SO<sub>2</sub>.

The SOD in poplar leaves was increased by fumigation with 0.1 ppm SO<sub>2</sub>. Production of SOD by 0.1 ppm SO<sub>2</sub> was more evident in young leaves than in old ones. The induced SOD was a cyanide-sensitive Cu, Zn-enzyme. The poplar leaves, which contained a high content of SOD induced by 0.1 ppm SO<sub>2</sub>-fumigation which were more resistant to 2.0 ppm SO<sub>2</sub> than control leaves which contained the usual level of this enzyme.

These findings suggest that SO<sub>2</sub> toxicity is contributed in part by the toxicity of the superoxide radical, and that SOD participates in the defense against SO<sub>2</sub> toxicity.

Key words: Induction of superoxide dismutase – Oxygen toxicity – SO<sub>2</sub> Resistance – SO<sub>2</sub> Toxicity – Superoxide dismutase

Numerous studies on physiological and biochemical effects of SO<sub>2</sub>, an air pollutant, on plant cell metabolism have been made in recent years (14,35). These studies are generally divided into two subjects, i.e., the toxic effects of SO<sub>2</sub> on plants and the mechanism of resistance of plants to SO<sub>2</sub> toxicity. The resistance of plants to SO<sub>2</sub> may be determined by the stomatal regulation of SO<sub>2</sub>-absorption and the defense at the physiological level against the toxicity of SO<sub>2</sub> absorbed. Menser and Heggstad reported that stomata of tobacco plants closed on SO<sub>2</sub>-fumigation (2, 5). Kondo and Sugahara suggested that abscisic acid in leaves controlled the rapid stomatal closure following SO<sub>2</sub>-fumigation (20). It is conceivable that the removal of protons produced in the dissolution of gaseous SO<sub>2</sub> in plant cells and the enzymatic and non-enzymatic oxidation or reduction of sulfite may also contribute to the resistance of plants to SO<sub>2</sub> toxicity (14, 31, 35).

---

Abbreviations: DDTC, diethyldithiocarbamate; SOD, superoxide dismutase

Lately, the importance of active oxygens in SO<sub>2</sub> toxicity has been proposed by some workers (28). One such active oxygen is the superoxide radical which is produced by illuminated chloroplasts. Chloroplasts are also the source of other active oxygens, hydrogen peroxide (H<sub>2</sub>O<sub>2</sub>), hydroxyl radical (OH<sup>•</sup>), and singlet oxygen (<sup>1</sup>O<sub>2</sub>). These active oxygens can cause non-specific oxidation of various chloroplast components, resulting in damages or death of plants.

However, Cu, Zn-superoxide dismutase contained in the stroma of chloroplasts renders the steady state concentration of O<sub>2</sub><sup>-</sup> in illuminated chloroplasts too low to cause the oxygen toxicity (7). Asada and Kiso reported that the presence of sulfite and/or bisulfite led to increased formation of O<sub>2</sub><sup>-</sup> through a free radical chain reaction initiated by O<sub>2</sub><sup>-</sup> in chloroplasts (4). It has been also proposed by Asada *et al.* that chloroplasts or green leaves were resistant to 10<sup>-9</sup> M O<sub>2</sub><sup>-</sup> but were damaged by 10<sup>-8</sup> to 10<sup>-7</sup> M O<sub>2</sub><sup>-</sup> (7).

There are reasons for believing that some of damages to plants apparently caused by SO<sub>2</sub>-fumigation might be due to the active oxygens. Shimazaki *et al.* showed that the destruction of chlorophyll and the formation of peroxidative product of unsaturated fatty acid, malondialdehyde in SO<sub>2</sub>-fumigated spinach leaves was caused by O<sub>2</sub><sup>-</sup> and <sup>1</sup>O<sub>2</sub>, respectively (29). Peiser and Yang observed that the production rates of ethylene and ethane increased after exposure of alfalfa plants to SO<sub>2</sub> and speculated that this might be ultimately caused by the active oxygens (28).

If the SO<sub>2</sub> toxicity contributed, even partly, to oxygen toxicity, plants might protect themselves against the SO<sub>2</sub>-induced oxygen toxicity using scavengers for active oxygens such as superoxide dismutase (SOD) and peroxidase. We now report that the high content of SOD in leaves correlated with the increased resistance to SO<sub>2</sub> toxicity and the level of SOD was increased by long term fumigation with a low concentration of SO<sub>2</sub>.

### Materials and methods

#### Plant materials

Poplar (*Populus euramericana*) cuttings were grown in pot, at 25 ± 0.5°C during the day and 20 ± 0.5°C at night, with a relative humidity of 75 ± 5% in a phytotron under natural light conditions for 5 to 7 weeks, until when their heights were 130 to 180 cm. Soil in pot was composed of vermiculite, peat moss, perlite, fine gravel and red clay (1:1:1:1:4). As nutrients, 8 g/liter hyponex was applied every 5 days. In addition to these nutrients, microelements of Hoagland No. 2 were added twice a week.

Spinach (*Spinacia oleracea* L. cv. New Asia) was grown in the same conditions as poplar, except that the temperature was 20 ± 0.5°C during the day and 15 ± 0.5°C at night with a relative humidity of 70 ± 5%. Soil of spinach was composed of vermiculite, peat moss, perlite and fine gravel (2:2:1:1). Nutrients were the same as in poplar, but no microelement was supplied.

#### SO<sub>2</sub> fumigation

The plants grown in a glass house were transferred to a cabinet (170 × 230 × 190 cm) for SO<sub>2</sub>-fumigation. The plants were preconditioned for 2 hr in the cabinet at 25 ± 0.5°C with a relative humidity of 75 ± 5% under a light of 25,000 to 35,000 lux at leaf level. The 2.0 ± 0.08 or 0.1 ± 0.01 ppm SO<sub>2</sub> was prepared by diluting 4,000 ppm SO<sub>2</sub> in nitrogen with the appropriate amount of air. The SO<sub>2</sub> concentration in the cabinet was measured with a pulsed fluorescent SO<sub>2</sub> analyzer (Thermo Electron Corp.). After SO<sub>2</sub>-fumigation, leaf punches (1.5 cm in diameter) of poplar or spinach were excised at indicated times. These

were homogenized in 0.1 M potassium phosphate (pH 7.8) with a Polytron (Kinematica PT 10/35) at 5°C. One part of the homogenates was used to determine chlorophyll and malondialdehyde. The remaining homogenates were centrifuged at 10,000 g for 30 min and the supernatants were dialyzed against two liters of 20 mM phosphate buffer (pH 7.8) with three changes of the buffer. After centrifugation of the dialyzed solution at 10,000 g for 30 min, the clear supernatant was used to determine protein and the activities of peroxidase and SOD.

#### *Analytical methods*

SOD was assayed according to McCord and Fridovich with a slight modification (24). The reaction was performed at 25°C in a total volume of 1 ml containing 50 mM potassium phosphate, pH 7.8, 0.1 mM EDTA, 0.01 mM cytochrome *c*, 0.1 mM xanthine and xanthine oxidase (5 to 10 µg), which was suspended in 2 M ammonium sulfate containing 1 mM EDTA adjusted to pH 8.0. The reaction was started by the addition of xanthine oxidase. One unit of SOD was defined as the amount of enzyme which was required to inhibit the reduction rate of cytochrome *c* by 50% under the assay conditions described above. The enzymatic unit is equal to  $(V/v - 1)$ , where *V* and *v* are the reduction rates in the absence and presence of the enzyme, respectively (6).

Peroxidase was assayed according to Siegel and Siegel (30). The reaction was performed in a total volume of 1 ml containing 100 mM potassium phosphate, pH 6.0, 0.1 mM EDTA, 1 mM guaiacol, 0.005% H<sub>2</sub>O<sub>2</sub> and crude enzymes. One unit of peroxidase was defined as the amount of enzyme increasing the absorbance at 470 nm by 1.0 per min.

Chlorophyll was determined according to Arnon (3). Protein was measured according to Lowry et al. (23). Lipid peroxidation products reactive to thiobarbituric acid were determined according to the method of Heath and Packer (16) and expressed as equivalent amounts of malondialdehyde.

All spectrophotometric determinations were carried out using a Shimadzu UV 200s recording spectrophotometer. Cytochrome *c* from horse heart (Type III) was obtained from Sigma. Xanthine oxidase from milk was a product of Boehringer.

## Results

### *Relationship between contents of SOD and damages by SO<sub>2</sub>-fumigation in poplar leaves at different ages*

As shown in Fig. 1A, young poplar leaves had higher activity of SOD than old ones did, although there was no significant difference in peroxidase. Fig. 1B shows that young poplar leaves were more resistant to the SO<sub>2</sub> toxicity than old lower ones. Here, the damage due to 2.0 ppm SO<sub>2</sub>-fumigation was expressed both by the amount of malondialdehyde formed by interaction of unsaturated fatty acids with singlet oxygen which was mostly produced from O<sub>2</sub><sup>-</sup> (33), and by the destruction of chlorophyll caused by O<sub>2</sub><sup>-</sup> (29). In poplar leaves, both indices of damage by SO<sub>2</sub>-fumigation agreed well with visible injuries. Fig. 1B suggests that the leaves, as they age, exhibit a decrease in the content of SOD and their resistance to SO<sub>2</sub> toxicity also decreases.

### *Lowering of resistance to SO<sub>2</sub> toxicity with SOD-inactivation*

According to Heikkilä *et al.*, administration of diethyldithiocarbamate (DDTC), a copper chelating agent, to mice lowered SOD activity in the brain, liver and erythrocytes (17). To examine whether the resistance to SO<sub>2</sub> toxicity in higher plants decreases or not

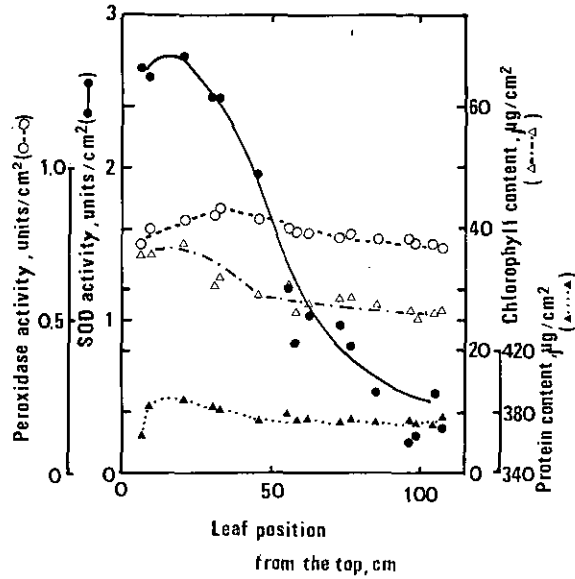

Fig. 1A. Contents of SOD, peroxidase, protein, and chlorophyll in poplar leaves at different ages. The horizontal axis shows the length from the top of stalk. The poplar plant at 30 days after cutting was used. Enzyme activities, protein and chlorophyll were determined as described in Materials and methods.

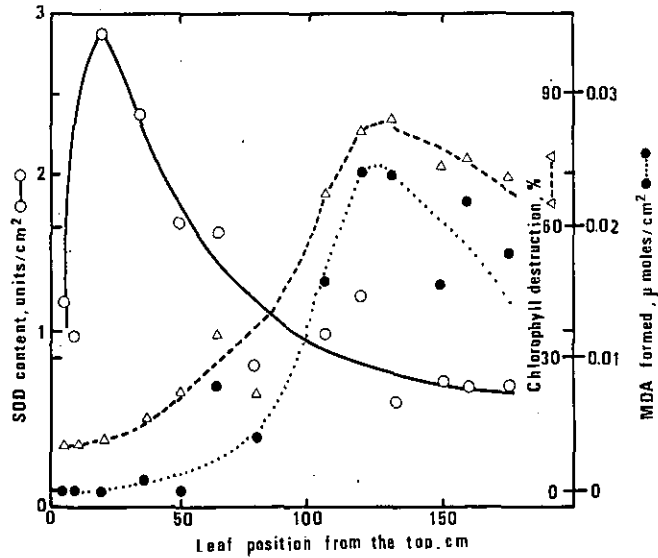

Fig. 1B. Relationship between the content of SOD and the resistance to  $SO_2$  in poplar leaves at different ages. SOD activity has been determined before  $SO_2$ -fumigation. After 2.0 ppm  $SO_2$ -fumigation for 22 hr, the formation of manondialdehyde and the destruction of chlorophyll were measured. The poplar plant at 40 days after cutting was used.



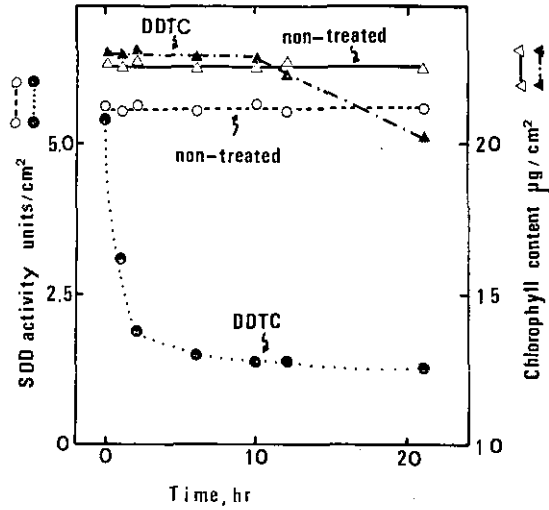

Fig. 2. Inactivation of SOD in spinach leaves by DDTC. The spinach leaves were sprayed with 2% DDTC in 20 mM potassium phosphate (pH 7.8). The leaves were collected at indicated times, washed fully with distilled water, then used to determine SOD and chlorophyll.

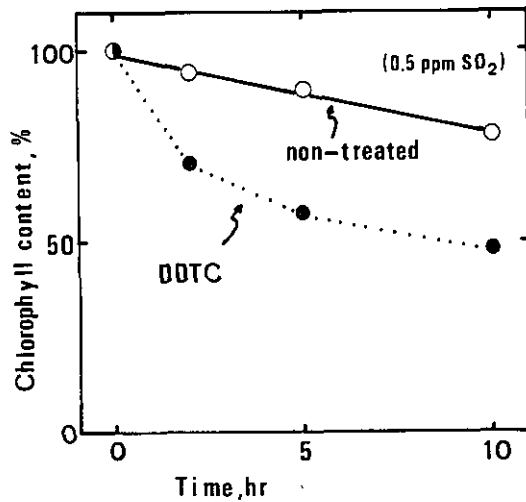

Fig. 3. Effect of  $SO_2$ -fumigation on spinach leaves, in which SOD was inactivated by DDTC. After spraying 2% DDTC in 20 mM potassium phosphate, pH 7.8, to spinach leaves the leaves were fumigated with 0.5 ppm  $SO_2$ . The content of chlorophyll was expressed as % of the content of chlorophyll in leaves without  $SO_2$ -fumigation, whether DDTC was sprayed or not.

when SOD was inactivated, 2% DDTC in 20 mM potassium phosphate, pH 7.8, was sprayed on the surface of spinach leaves under light (30,000 lux). After spraying with

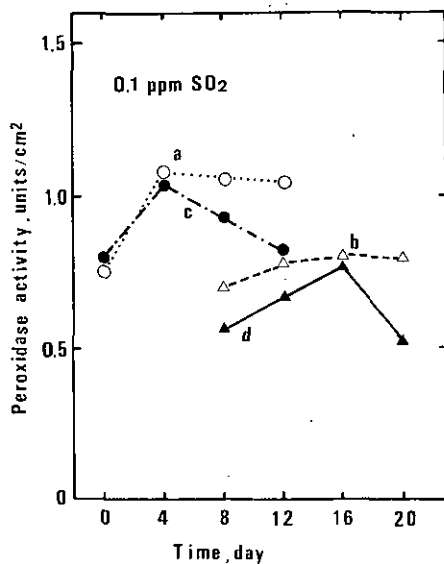
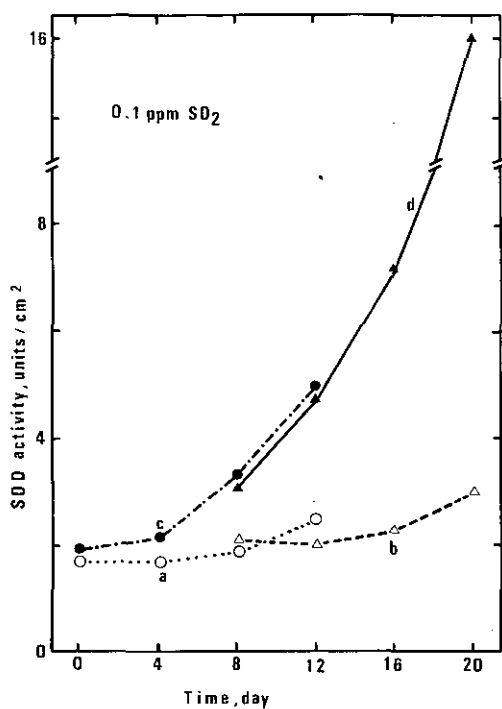

Fig. 4. Induction of SOD by long term fumigation with 0.1 ppm SO<sub>2</sub>. The poplar plant at 30 days after cutting was fumigated with 0.1 ppm SO<sub>2</sub> for 20 days. Both SOD (A, upper) and peroxidase (B, lower) activities of leaves in the fifth to eighth positions at eight days after 0.1 ppm SO<sub>2</sub>-fumigation were also followed (b; control, d; SO<sub>2</sub>-fumigation).

Sulfite toxicity and superoxide dismutase

DDTC the activity of SOD decreased by 65% after 2 hr and thereafter it gradually diminished by 77% after 22 hr (Fig. 2). Chlorophyll content was constant during 10 hr, then it gradually decreased. These observations suggest that  $O_2^-$  concentration increases in chloroplasts with the inactivation of SOD by DDTC which causes the destruction of chlorophyll. After spraying with DDTC the leaves were fumigated with 0.5 ppm  $SO_2$ . The chlorophyll destruction by  $SO_2$ -fumigation was enhanced by DDTC-treatment (Fig. 3). These results show that the inactivation of SOD lowers the resistance of spinach leaves to  $SO_2$  toxicity.

*Induction of poplar SOD with  $SO_2$ -fumigation*

It has been reported that the biosynthesis of SOD is induced in some organisms

Table 1 *Induction of Cu, Zn-SOD in poplar leaves by  $SO_2$*

	SOD activity (units/cm <sup>2</sup> )	
	(b)	(d)
total	3.6	16.0
CN-sensitive	2.8	14.8
CN-insensitive	0.8	1.3

Both crude enzymes of d and b (d; poplar plant at 20 days after 0.1 ppm  $SO_2$ -fumigation, b; control) were incubated for 30 min in 5 mM KCN in 50 mM potassium phosphate, pH 7.8, at 25°C, before the assay of SOD was done.

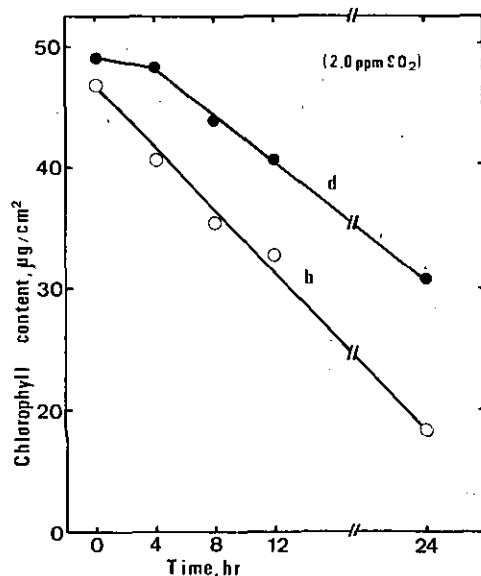

Fig. 5. *Effect of 2.0 ppm  $SO_2$ -fumigation on poplar plants in which the content of SOD was increased with 0.1 ppm  $SO_2$ -fumigation. Both poplar leaves of d and b (d; at 20 days after 0.1 ppm  $SO_2$ -fumigation, b; control) were fumigated with 2.0 ppm  $SO_2$ .*

under the conditions where the rate of intracellular production of  $O_2^-$  is high (11). If SOD content in plant leaves increases by the induction of the enzyme their resistance to  $SO_2$  toxicity in the leaves should increase. To test this point of view, poplar plants were exposed to 0.1 ppm  $SO_2$  for 20 days. No visible injury of leaves was observed. Fig. 4A shows that the SOD activity in poplar leaves, at the fifth to eighth position (approximately 20 to 30 cm) from the top, increased during  $SO_2$ -fumigation. The SOD content in the fumigated leaves became twice as much as the enzyme in the unfumigated leaves with the 12 days-fumigation (Fig. 4A, c, a). The SOD activity in the newly grown fifth to eighth leaves during 8 days-fumigation (corresponding to the first to fourth ones of the starting plants) increased 4.4 times as much as the control after the next 12 days (Fig. 4A, d, b). Here, the induction of SOD was greater in younger leaves than in older ones. Under the same conditions there was little difference between  $SO_2$  fumigated leaves and the control in the content of peroxidase (Fig. 4B). Table 1 demonstrates that the Cu, Zn-SOD was induced, because the Cu, Zn-enzyme was sensitive to cyanide, while the Fe- and Mn-enzyme were insensitive (10). These observations suggest that superoxide radicals increased by  $SO_2$ -fumigation induced the biosynthesis of Cu, Zn-SOD.

The poplar leaves, which had contained 4.4 times as much SOD as the control by fumigation with 0.1 ppm  $SO_2$  for 20 days, were exposed to 2.0 ppm  $SO_2$ . As shown in Fig. 5, the decrease in chlorophyll content in high SOD-leaves (fumigated, d) was less than that of control leaves (unfumigated, b). The results indicate that the leaves with induced-SOD acquired a greater resistance to  $SO_2$  toxicity than the control.

#### Discussion

Although it is well known that the degree of plant damage by air pollutants varies depending on various factors such as species or varieties of plants, nutritive conditions of plants, ages of plants, gaseous conditions around plants, light conditions and so on, there have been few reports on the relationship between plant resistance to  $SO_2$  and the physiological response of plants to  $SO_2$  (9, 14). The  $SO_2$  toxicity may be classified into direct and indirect effects of sulfite on plants. Studies on the former have prevailed. However, it remains to be resolved how much sulfite concentration accumulates in leaves of higher plants exposed to gaseous  $SO_2$ . Judging from *in vitro* experiments, sulfite exhibits toxicity at  $10^{-3}$  to  $10^{-2}$  M in leaves (36). However, it is doubtful whether such a high concentration of sulfite accumulates in leaves (26).

On the other hand, it has been recognized that  $O_2^-$  at  $10^{-8}$  to  $10^{-7}$  M causes plant damage such as chlorophyll destruction (7), and that hydrogen peroxide at  $10^{-5}$  to  $10^{-4}$  M produced from the dismutation of  $O_2^-$  in chloroplast inactivates the  $CO_2$ -fixation (18, 19). It is likely that the active oxygen at such concentrations accumulates in leaves in the presence of sulfite. Evidence has been presented showing that  $SO_2$ -fumigation of plant leaves increases the concentration of  $O_2^-$  in chloroplast which destroys chlorophylls and lipids (29). Therefore, it is important in  $SO_2$ -detoxification to remove the  $O_2^-$  from chloroplasts. In addition to scavenging of  $O_2^-$  by SOD,  $O_2^-$  is also removed by interaction with several components in the chloroplast such as cytochrome *f*, plastocyanin, ferredoxin, ascorbate, reduced glutathione and  $Mn^{2+}$  (2, 8, 21, 24, 27, 34). However, the contribution of these compounds to the scavenging of  $O_2^-$  is only several percents of that of SOD (7). As shown in Fig. 1A and 1B, the poplar leaves gradually lost their SOD with aging and the amount of SOD in leaves was correlated with plant resistance to  $SO_2$  toxicity. Administration of DDTc to spinach leaves inactivated SOD in leaves (Fig. 2).

The SOD-inactivated spinach leaves were less tolerant to SO<sub>2</sub> than the control (Fig. 3). The observations (Figs. 1, 2 and 3) suggest that SOD participates in the defence against SO<sub>2</sub> toxicity.

The induction of SOD has been reported in some organisms. In *Streptococcus faecalis* (12), *Pseudomonas ovuris* (11), and *Saccharomyces cerevisiae* (13), high concentration of oxygen produced SOD. In *Anacystis nidulans*, the photooxidative conditions increased the level of SOD (1). Hassan and Fridovich reported that the addition of methyl viologen to *E. coli* caused a rapid pronounced increase in the rate of biosynthesis of SOD (15). In all cases the cells which contained high levels of SOD were thereby rendered more resistant to the lethality of hyperbaric oxygen. Induction of SOD and parallel acquisition of oxygen tolerance have also been seen in lung of whole rat (11, 32). However, there has been no report on the induction of SOD in higher plants.

In the present study, when the poplar leaves were fumigated with 0.1 ppm SO<sub>2</sub> the level of SOD gradually increased (Fig. 4A). We consider that this increase in SOD was caused by increased synthesis of this enzyme triggered by O<sub>2</sub><sup>-</sup>, which was produced through sulfite-mediated chain reactions in chloroplasts. Table 1 shows that the SOD produced by SO<sub>2</sub>-fumigation was a Cu, Zn-SOD. Therefore, higher plants may have a different mechanism of enzyme synthesis than in other organisms. As shown in Fig. 5, the poplar leaves which acquired high levels of SOD by virtue of fumigation of a low concentration of SO<sub>2</sub> (0.1 ppm) were more resistant to the toxicity of a higher concentration of SO<sub>2</sub> (2.0 ppm). These observations suggest that part of the SO<sub>2</sub> toxicity originates from oxygen toxicity and that SOD plays an important role in the detoxification of SO<sub>2</sub>.

There has been little report on any physiological changes in higher plant leaves on SO<sub>2</sub>-fumigation at such low concentration (0.1 ppm). The induction of SOD with SO<sub>2</sub>-fumigation may be interesting as a biochemical indicator of SO<sub>2</sub> pollution. Through determination of SOD contents in leaves of higher plants in the field it may be possible to estimate the environmental pollution in the atmosphere.

#### Reference

1. Abeliovich, A., D. Kellenberg and M. Shilo: Effects of photooxidative conditions on levels of superoxide dismutase in *Anacystis nidulans*. *Photochem. Photobiol.* 19: 379-382 (1974).
2. Allen, J.F.: A two-step mechanism for the photosynthetic reduction of oxygen by ferredoxin. *Biochem. Biophys. Res. Commun.* 66: 36-43 (1975).
3. Arnon, D. I.: Copper enzymes in isolated chloroplasts. Polyphenol oxidase in *Beta vulgaris*. *Plant Physiol.* 24: 1-15 (1949).
4. Asada, K. and K. Kiso: Initiation of aerobic oxidation of sulfite by illuminated spinach chloroplasts. *Eur. J. Biochem.* 33: 253-257 (1975).
5. Asada, K., K. Kiso and K. Yoshikawa: Univalent reduction of molecular oxygen by spinach chloroplasts on illumination. *J. Biol. Chem.* 249: 2175-2181 (1974).
6. Asada, K., M. Takahashi and M. Nagate: Assay and inhibitors of spinach superoxide dismutase. *Agric. Biol. Chem.* 38: 471-473 (1974).
7. Asada, K., M. Takahashi, K. Tanaka and Y. Nakano. 1977. Formation of active oxygen and its fate in chloroplast. In: *Biochemical and Medical Aspects of Active Oxygen*. Ed. by O. Hayaishi and K. Asada, pp. 45-63. University of Tokyo Press, Japan
8. Asada, K. and S. Kanematsu: Reactivity of thiols with superoxide radicals. *Agric. Biol. Chem.* 40: 1891-1892 (1976).
9. Bressan, R. A., L. G. Wilson and P. Filner: Mechanisms of resistance to sulfur dioxide in the cucurbitaceae. *Plant Physiol.* 61: 761-767 (1978).
10. Fridovich, I.: Superoxide dismutase. *Annu. Rev. Biochem.* 44: 147-159 (1975).
11. Fridovich, I.: Biological aspects of superoxide radical and superoxide dismutases. In: *Biochemical*

- and Medical Aspects of Active Oxygen. Ed. by G. Hayaishi & K. Asada, pp. 171-181. University of Tokyo Press, Japan. 1977.
12. Gregory, E. M. and I. Fridovich: Induction of superoxide dismutase by molecular oxygen. *J. Bacteriol.*, 114: 543-548 (1973).
  13. Gregory, E. M., S. A. Goscin and I. Fridovich: Superoxide dismutase and oxygen toxicity in a eukaryote. *J. Bacteriol.* 117: 456-460 (1974).
  14. Hallgren, J. E.: Physiological and biochemical effects of sulfur dioxide on plants. In: *Sulfur in the Environment*. Ed. by J. O. Nriagu, pp. 163-209. A Wiley-Interscience Publication, John Wiley & Sons, U.S.A., 1978.
  15. Hassan, H. M. and I. Fridovich: Regulation of the synthesis of superoxide dismutase in *Escherichia coli*: induction by methyl viologen. *J. Biol. Chem.* 252: 7667-7672 (1977).
  16. Heath, R. L. and L. Packer: Photoperoxidation in isolated chloroplasts. I. Kinetics and stoichiometry of fatty acid peroxidation. *Arch. Biochem. Biophys.* 125: 189-198 (1968).
  17. Heikkila, R. E., F. S. Cabbat and G. Cohen: In vivo inhibition of superoxide dismutase in mice by diethylthiocarbamate. *J. Biol. Chem.* 251: 2182-2185 (1976).
  18. Kaiser, W. M.: The effect of hydrogen peroxide on CO<sub>2</sub>-fixation of isolated intact chloroplasts. *Biochim. Biophys. Acta* 440: 476-482 (1976).
  19. Kaiser, W. M.: Reversible inhibition of the Calvin cycle and activation of oxidative pentose phosphate cycle in isolated intact chloroplasts by hydrogen peroxide. *Planta* 145: 377-382 (1979).
  20. Kondo, N. and K. Sugahara: Changes in transpiration rate of SO<sub>2</sub>-resistant and -sensitive plants with SO<sub>2</sub> fumigation and the participation of abscisic acid. *Plant & Cell Physiol.* 19: 365-373 (1978).
  21. Kono, Y., M. Takahashi and K. Asada: Reduction of plastocyanin by O<sub>2</sub><sup>-</sup>. *Seikagaku* 47: 336 (1975).
  22. Kono, Y., M. Takahashi and K. Asada: Oxidation of manganous pyrophosphate by superoxide radicals and illuminated spinach chloroplasts. *Arch. Biochem. Biophys.* 174: 454-462 (1976).
  23. Lowry, O. H., N. J. Rosebrough, A. H. Farr and R. J. Randall: Protein measurement with the Folin phenol reagent. *J. Biol. Chem.* 193: 256-275 (1951).
  24. McCord, J. M. and I. Fridovich: Superoxide dismutase: an enzymic function of erythrocyte. *J. Biol. Chem.* 244: 6049-6055 (1969).
  25. Menser, H. A. and H. E. Heggstad: Ozone and Sulfur dioxide synergism: injury to tobacco plants. *Science* 153: 424-425 (1966).
  26. Miller, J. E. and P. B. Xerikos, P. B.: Residence time of sulphite in SO<sub>2</sub> 'sensitive' and 'tolerant' soybean cultivars. *Environ. Pollut.* 18: 259-264 (1979).
  27. Nishikimi, M.: Oxidation of ascorbic acid with superoxide anion generated by the xanthine-xanthine oxidase system. *Biochem. Biophys. Res. Commun.* 63: 463-468 (1975).
  28. Peiser, G. D. and S. F. Yang: Ethylene and ethane production from sulfur dioxide-injured plants. *Plant Physiol.* 61: 142-145 (1979).
  29. Shimazaki, K., T. Sakaki and K. Sugahara: Active oxygen participation in chlorophyll destruction and lipid peroxidation in SO<sub>2</sub>-fumigated leaves of spinach. In *this Research Report*.
  30. Siegel, B. Z. and S. M. Siegel: Anomalous substrate specificities among the algal peroxidases. *Amer. J. Bot.* 57: 285-287 (1970).
  31. Smith, L. K. and J. F. Thompson: The synthesis of O-acetylserine by reacts prepared from higher plants. *Biochem. Biophys. Res. Commun.* 35: 929-945 (1969).
  32. Stevens, J. B. and A. P. Auter: Induction of superoxide dismutase by oxygen in neonatal rat lung. *J. Biol. Chem.* 252: 3509-3514 (1977).
  33. Takahama, U. and M. Nishimura: Effects of electron donor and acceptors, electron transfer mediators and superoxide dismutase on lipid peroxidation on illuminated chloroplast fragments. *Plant & Cell Physiol.* 17: 111-118 (1976).
  34. Tanaka, K., M. Takahashi and K. Asada: Isolation of monomeric cytochrome *f* from Japanese radish and a mechanism of autoreduction. *J. Biol. Chem.* 253: 7397-7403 (1978).
  35. Thompson, J. F.: Sulfur metabolism in plants. *Ann. Rev. Plant Physiol.* 18: 59-84 (1967).
  36. Ziegler, I.: The effect of SO<sub>3</sub><sup>2-</sup> on the activity of ribulose-1, 5-diphosphate carboxylase in isolated spinach chloroplasts. *Planta* 103: 155-163 (1972).

## Formation and scavenging of superoxide in chloroplasts, with relation to injury by sulfur dioxide

Kozi Asada

The Research Institute for Food Science, Kyoto University, Uji, Kyoto 611

Injury of plant leaf cells by sulfur dioxide-exposure is greater in day time than in night. A hypothesis is proposed that the free radical chain oxidation of sulfite is initiated by the superoxide radicals ( $O_2^-$ ) produced in illuminated chloroplasts, and that the resulting amplified production of  $O_2^-$ , the hydroxyl radicals and the bisulfite radicals causes the injury of leaf tissues. In this review, the production of  $O_2^-$  in illuminated chloroplasts and scavenging of  $O_2^-$  by superoxide dismutase and their relation to oxidation of sulfite in chloroplasts are discussed. Superoxide dismutase in chloroplasts plays an important role in protecting leaf cells from injury by sulfur dioxide.

**Key words:** Chloroplasts – Hydroxyl radical – Scavengers for superoxide – Sulfite radical – Superoxide dismutase – Superoxide radical

The superoxide anion radical ( $O_2^-$ ) is formed through the univalent reduction of molecular oxygen. In aerobic organisms, this radical is mainly produced by several oxidases, autooxidation of reductants having a low redox potential and by photochemical reactions (1, 15, 16). Spontaneous or superoxide dismutase-catalyzed disproportionation of  $O_2^-$  produces  $H_2O_2$  and  $O_2$ ;



Interaction among  $H_2O_2$ ,  $O_2^-$  and cell components produce the hydroxyl radical ( $OH\cdot$ ) and singlet excited oxygen ( $^1O_2$ ). Thus, active oxygen such as  $H_2O_2$ ,  $OH\cdot$ , and  $^1O_2$  is formed from  $O_2^-$  in the cells (1,16). These reduced and excited molecular species of oxygen are highly reactive and oxidize cell components bringing about cellular damage if there is no scavenging system for these species of oxygen. In the normal state cells of aerobes are protected from active oxygen by scavengers such as superoxide dismutase for  $O_2^-$ , catalase and peroxidase for  $H_2O_2$ , and tocopherols and carotenoids for  $^1O_2$  (1, 16). For the hydroxyl radicals no specific scavenger has been found, but, polyhydroxy compounds such as carbohydrates are very reactive with this radical and may prevent oxidation of biologically important cell components.

The cells of plant leaves are similar to cells of aerobes in respect to the formation of active oxygen and their scavengers. It has been observed that damage of plants by air pollutants is generally greater in day time than in night, especially in the case of sulfur

dioxide (see No. 9 paper in this issue). Since  $O_2^-$  is produced in chloroplasts on illumination, one of the causes of leaf damage in day time is attributable to the interaction of the pollutants with superoxide. In this paper the formation of  $O_2^-$  in chloroplasts under illumination and the interaction of sulfite with  $O_2^-$  are described. The free radical chain oxidation of sulfite is initiated by photoproducted  $O_2^-$  in chloroplasts and results in the amplified production of  $O_2^-$ , the hydroxyl and bisulfite radicals. Subsequently, the scavenging systems for  $O_2^-$  in chloroplasts and the participation of these systems in protecting the plant cells from deleterious effects of sulfur dioxide are discussed.

### I. Production of superoxide in chloroplasts and factors affecting it

The reduction of molecular oxygen by illuminated chloroplasts was first found by Mehler (29) who identified  $H_2O_2$  as a reduced product of  $O_2$ . Recently, it has been made clear that  $H_2O_2$  is a dismutation product of  $O_2^-$  which is the primary reduced product of  $O_2$  by a photoreductant of chloroplasts (8, 21). The production of  $O_2^-$  has been demonstrated by  $O_2^-$ -induced reactions with illuminated chloroplasts and their inhibitions by superoxide dismutase (8).

Figure 1 shows the reduction of cytochrome *c* by chloroplasts on illumination and its inhibition by superoxide dismutase (6). The reduction of cytochrome *c* by  $O_2^-$  has been confirmed in several  $O_2^-$ -generating systems. Its inhibition by superoxide dismutase confirms that the reduction is mediated by  $O_2^-$  and that cytochrome *c* is not reduced directly by a photoreductant. Thus, a photoreductant formed in chloroplasts reduces univalently molecular oxygen to form  $O_2^-$  which, in turn, reduces cytochrome *c*. The production of  $O_2^-$  in chloroplasts has been shown by other  $O_2^-$ -induced reactions such as the oxidation of sulfite (see below), epinephrine, ascorbate,  $Mn^{2+}$ , tiron and of

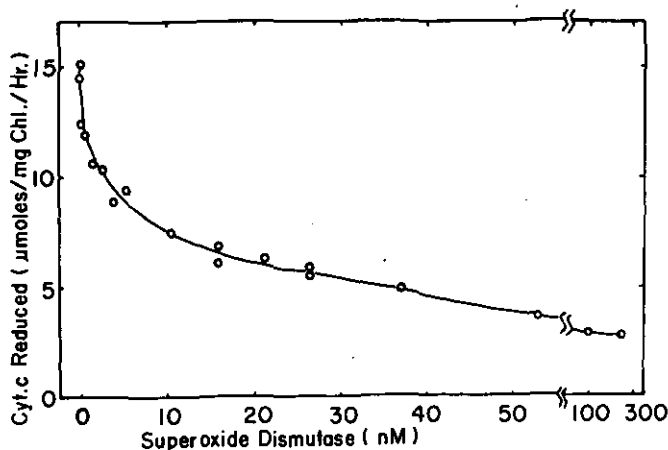

Fig. 1. Effect of superoxide dismutase on the photoreduction of cytochrome *c* by spinach chloroplasts. The reaction mixture (2 ml) contained 50 mM potassium phosphate, pH 7.8, 10 mM NaCl, 20  $\mu$ M ferricytochrome *c*, chloroplasts containing 10  $\mu$ g of chlorophyll and indicated amount of Cu, Zn-superoxide dismutase. Reaction rates were determined from the initial absorbance change 20 s after illumination. (Asada *et al.* (1974) (6)).



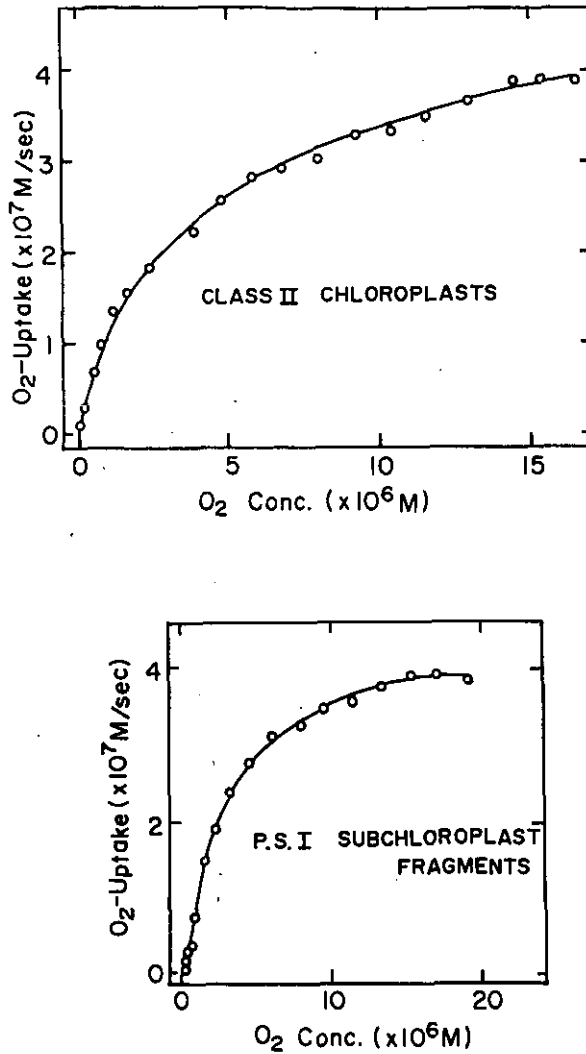

Fig. 2. Effect of oxygen concentration on photoreduction of oxygen by class II chloroplasts and by photosystem I subchloroplast fragments.

The reaction mixture (1 ml) contained in (A): 50 mM Tris-Cl, pH 7.8, 0.2 mM azide, 1  $\mu$ M 3 (3,4-dichlorophenyl)-1, 1-dimethylurea, 0.2 mM dichlorophenol-indophenol, 10 mM ascorbate and chloroplasts (19.1  $\mu$ g chlorophyll); in (B) 50 mM Tris-Cl, pH 7.8, 0.2 mM dichlorophenolindophenol, 10 mM ascorbate, 0.1% Triton X-100 and chloroplast fragments (0.2  $\mu$ g chlorophyll). After removal of O<sub>2</sub> in the reaction medium by bubbling argon to about 30  $\mu$ M, the O<sub>2</sub>-uptake was followed under white light. (Asada and Nakano (1978) (7)).

hydroxylamine (8). The primary electron acceptor in photosystem I is the most probable photoreductant of O<sub>2</sub> (6).

The reactivity of the primary electron acceptor in photosystem I with O<sub>2</sub> is very high

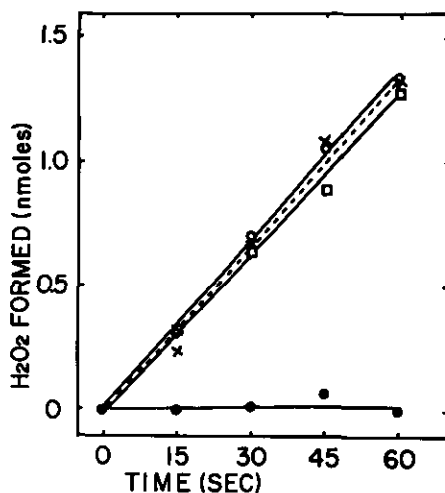

Fig. 3. Effect of superoxide dismutase and cytochrome *c* on the production of hydrogen peroxide by illuminated spinach chloroplasts. The reaction mixture contained 50 mM phosphate, pH 7.8, 10 mM NaCl, and chloroplasts (10  $\mu\text{g}$  chlorophyll), in a total volume of 2 ml (o—o). In addition to the above mixture, 20  $\mu\text{M}$  cytochrome *c* (●—●), 20  $\mu\text{M}$  cytochrome *c* and 0.53  $\mu\text{M}$  superoxide dismutase (x---x), or 0.53  $\mu\text{M}$  superoxide dismutase (■—■) were added. (Asada *et al.* (1974) (6)).

Table 1  $K_m$  values for oxygen of  $\text{O}_2$ -uptake reactions in leaf cells under the light

Reactions	Location in cells	$K_m$ for $\text{O}_2$ (M)
Photoreduction in photosystem I	Chloroplast thylakoids	$2 \sim 3 \times 10^{-6}$
Ribulose biphosphate + $\text{O}_2 \rightarrow$ Phosphoglycolate + 3-Phosphoglycerate (Ribulose biphosphate carboxylase/ oxygenase)	Chloroplast stroma	$2 \times 10^{-4}$
Glycolate + $\text{O}_2 \rightarrow$ Glyoxylate + $\text{H}_2\text{O}_2$ (Glycolate oxidase)	Peroxisomes	$10^{-4} \sim 10^{-5}$
Glycine + ( $\text{NAD} \rightarrow \text{O}_2$ ) $\rightarrow$ Serine + $\text{CO}_2$ + $\text{NH}_3$ + ATP (Glycine decarboxylase-Serine hydroxy- methyl transferase $\rightarrow$ Cytochrome <i>c</i> oxidase)	Mitochondria	$\sim 10^{-7}$

(7). Apparent  $K_m$  values for  $\text{O}_2$  in class II chloroplasts and in photosystem I subchloroplast fragments are both  $2$  to  $3 \times 10^{-6}$  M, about a hundredth concentration of that in air-saturated water (Fig. 2). Similar values have been obtained also by Lien and San Pietro (28).  $E'_0$  of P-430, the primary electron acceptor in photosystem I, is  $-0.53$  V (25) and  $E'_0$  of  $\text{O}_2/\text{O}_2^-$  is  $-0.16$  V when molar concentration is used for  $\text{O}_2$ . Thus,  $\Delta E'_0$  between P-430 and  $\text{O}_2/\text{O}_2^-$  is large enough to reduce  $\text{O}_2$  and the autooxidation rate of

P-430 in photosystem I subchloroplast fragments is high;  $\sim 10^7 \text{ M}^{-1} \text{ s}^{-1}$  (7).

In the presence of cytochrome *c* the accumulation of  $\text{H}_2\text{O}_2$  is not detectable indicating that  $\text{O}_2^-$  is trapped by the cytochrome (Fig. 3). In addition, Fig. 3 shows that  $\text{H}_2\text{O}_2$  is formed only through the dismutation of  $\text{O}_2^-$  in chloroplasts.  $\text{H}_2\text{O}_2$  accumulates in the absence of cytochrome *c* or in the presence of cytochrome *c* and superoxide dismutase. Thus, the divalent reduction of molecular oxygen does not occur in chloroplasts (6).

In addition to the univalent reduction in photosystem I leaf cells uptake  $\text{O}_2$  in several reactions, even under illuminated conditions. Table 1 summarizes these reactions with their  $K_m$  values for  $\text{O}_2$ . Ribulose biphosphate carboxylase/oxygenase produces the substrate for photorespiration, phosphoglycolate. Two other reactions in peroxisomes and in mitochondria participate in the glycolate pathway of photorespiration. Oxygenase supplies the substrate for the last two reactions in Table 1, thus, the photoreduction of  $\text{O}_2$  is the major  $\text{O}_2$ -uptake at low  $\text{O}_2$  concentration, while the  $\text{O}_2$ -uptake due to the oxygenase and to the accompanying photorespiration increases with an increase of  $\text{O}_2$ -concentration.

Competition occurs between  $\text{CO}_2$  and  $\text{O}_2$  for the primary electron acceptor in photosystem I in intact chloroplasts that are able to evolve  $\text{O}_2$  depending on  $\text{CO}_2$ . Under conditions where  $\text{CO}_2$  is deficient or the carbon cycle for  $\text{CO}_2$ -fixation is inhibited,  $\text{O}_2$  is reduced in place of  $\text{CO}_2$ . Fig. 4 shows that in intact chloroplasts the  $\text{O}_2$ -uptake starts when  $\text{CO}_2$  has been consumed (A) or when ribulose biphosphate carboxylase/oxygenase has been inhibited by cyanide (B). The uptake was observed in chloroplasts that contain an endogenous electron donor for  $\text{H}_2\text{O}_2$ , otherwise the evolution of  $\text{O}_2$  ceases. The effect of cyanide indicates that most of the  $\text{O}_2$ -uptake in Fig. 4 is due to the photoreduction of  $\text{O}_2$  in photosystem I rather than the oxygenase reaction. Direct evidence for the light-dependent  $\text{O}_2$ -uptake has been attained in algal cells. The  $^{18}\text{O}_2$ -uptake under light is high under the conditions where  $\text{CO}_2$  is not fixed. The  $^{18}\text{O}_2$ -uptake by algal cell is also affected little by cyanide (36).

Thus, the photoreduction of  $\text{O}_2$  and the formation of  $\text{O}_2^-$  in photosystem I are not an artifact of isolated chloroplasts. It has been suggested that the reduction of  $\text{O}_2$  is

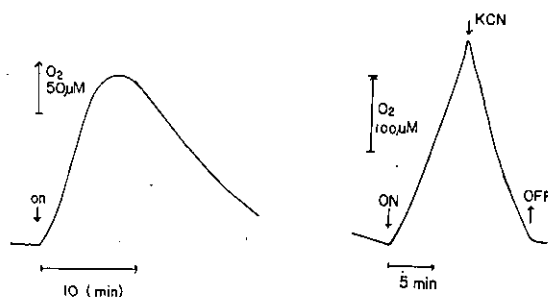

Fig. 4. Effect of bicarbonate and cyanide on the  $\text{O}_2$ -evolution by intact spinach chloroplasts. In (A) the reaction mixture (1 ml) contained 50 mM *N*-2-hydroxyethyl piperazine-*N'*-ethanesulfonic acid (HEPES)-KOH, pH 7.6, 0.33 M sorbitol, 0.41 mM  $\text{HCO}_3^-$  and intact chloroplasts (50  $\mu\text{g}$  of chlorophyll). On; white light of a projector lamp ( $1024 \text{ W/m}^2$ ). In (B) the reaction mixture (1 ml) contained 0.33 M sorbitol, 0.5 mM  $\text{HCO}_3^-$ , 50 mM HEPES-KOH, pH 7.6, and intact chloroplasts (154  $\mu\text{g}$  of chlorophyll). KCN (1 mM) was added where indicated. (Nakano and Asada, unpublished).

essential to the production of ATP by pseudocyclic photophosphorylation and to adjusting the ratio of ATP and NADPH<sub>2</sub> for the carbon cycle of CO<sub>2</sub>-fixation (12). For this reason O<sub>2</sub><sup>-</sup> may be produced even when the physiological electron acceptor, CO<sub>2</sub>, is sufficiently supplied to chloroplasts. In fact, the <sup>18</sup>O-experiments show that O<sub>2</sub>-uptake occurs when algal cells or intact chloroplasts evolve O<sub>2</sub> depending on CO<sub>2</sub> (12, 36).

Direct determination of O<sub>2</sub><sup>-</sup>-production in leaf cells is difficult and the production may be variable depending on environmental conditions. A low  $K_m$  value for O<sub>2</sub> of the photoreduction of O<sub>2</sub> (Table 1) and the evolution of O<sub>2</sub> in photosystem II suggests that O<sub>2</sub> in chloroplasts is not likely to limit the production of O<sub>2</sub><sup>-</sup>. In contrast, CO<sub>2</sub> concentration and its transport to chloroplasts affect the production of O<sub>2</sub><sup>-</sup>, as indicated by the results in Fig. 4. Under natural conditions, CO<sub>2</sub>-deficiency frequently occurs when the stomata is closed by water stress or the concentration of CO<sub>2</sub> in the atmosphere around the leaves decreases due to CO<sub>2</sub>-fixation or to a lack of air circulation. Under these circumstances, O<sub>2</sub> would be reduced in place of CO<sub>2</sub>.

As discussed above the production rate of O<sub>2</sub><sup>-</sup> in chloroplasts is variable depending on environmental conditions, particularly, on CO<sub>2</sub> concentration and light intensity. Therefore, the following is only an estimate: if 10% of photosynthetic capacity of electron transport in chloroplasts (~200  $\mu$ equivalent mg Chl<sup>-1</sup> hr<sup>-1</sup>) is used for the reduction of O<sub>2</sub> (~20  $\mu$ mol mg Chl<sup>-1</sup> hr<sup>-1</sup>) then the production rate of O<sub>2</sub><sup>-</sup> will be  $1.3 \times 10^{-4}$  M s<sup>-1</sup> in intact chloroplasts. In this estimation, chlorophyll concentration in intact chloroplasts is assumed to be  $2.5 \times 10^{-2}$  M (33).

## II. Initiation of sulfite oxidation by superoxide

Aerobic oxidation of sulfite to sulfate is initiated by metal ions, ultraviolet irradiation and by several O<sub>2</sub><sup>-</sup>-generating systems. The oxidation of sulfite is induced by illuminated chloroplasts which provides an additional evidence for the production of O<sub>2</sub><sup>-</sup> in chloroplasts (Fig. 5) (5). The oxidation rate of sulfite (~20 mmol mg Chl<sup>-1</sup> hr<sup>-1</sup>) is higher than the rate of O<sub>2</sub><sup>-</sup>-production determined by photoreduction of cytochrome *c*

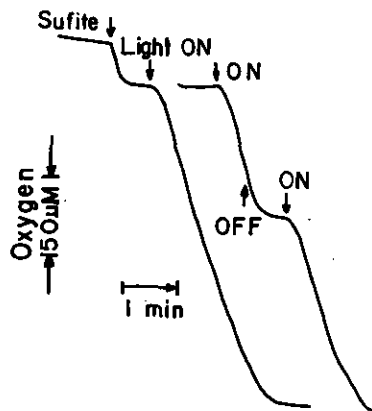
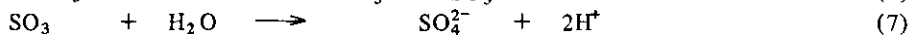
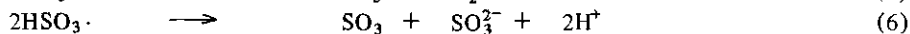
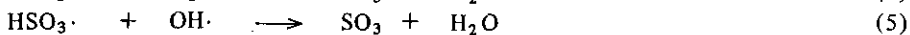
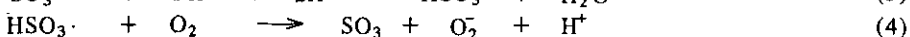
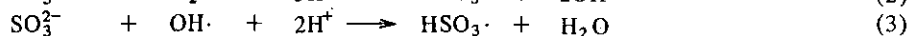
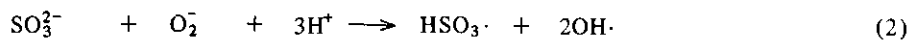

Fig. 5. Light-dependent oxidation of sulfite by spinach chloroplasts. The reaction mixture (2 ml) contained 50 mM phosphate, pH 6.8, 2.5 mM sulfite and chloroplasts containing 3  $\mu$ g chlorophyll. (Asada and Kiso (1973) (5)).

( $\sim 15 \mu\text{mol mg Chl}^{-1} \text{ hr}^{-1}$ ). This indicates that the oxidation of sulfite proceeds as a chain reaction which has been observed in the other initiating system (6). Thus, photo-produced  $\text{O}_2^-$  is a "trigger" of the chain oxidation of sulfite in chloroplasts.

The following reaction sequence has been proposed for the chain oxidation of sulfite initiated by  $\text{O}_2^-$  (39, 41);



In addition to  $\text{O}_2^-$ ,  $\text{OH}\cdot$  is also able to initiate the chain reaction. The reactions (2), (3), (4) and (5) are chain propagating reactions in which  $\text{O}_2^-$ ,  $\text{OH}\cdot$  and  $\text{HSO}_3\cdot$  are the chain carriers. The reaction (6) is the disproportionation of  $\text{HSO}_3\cdot$  radical and is the chain terminating reaction. The reaction (7) is the hydration of  $\text{SO}_3$  forming sulfate. Besides reaction (6), reaction (1), the disproportionation of  $\text{O}_2^-$ , and reaction (8) are chain terminating reaction.

Both  $\text{O}_2^-$  and  $\text{OH}\cdot$  are chain initiator and carrier, therefore, the scavengers for these radicals are expected to inhibit the oxidation of sulfite. Superoxide dismutase inhibits oxidation of sulfite with illuminated chloroplasts (Fig. 6) and the other scavenger for  $\text{O}_2^-$  such as cytochrome *c* also inhibits the reaction (5). However, catalase does not affect the oxidation.  $\text{H}_2\text{O}_2$ , *per se*, is a poor initiator of sulfite oxidation (17). Mannitol, a potent

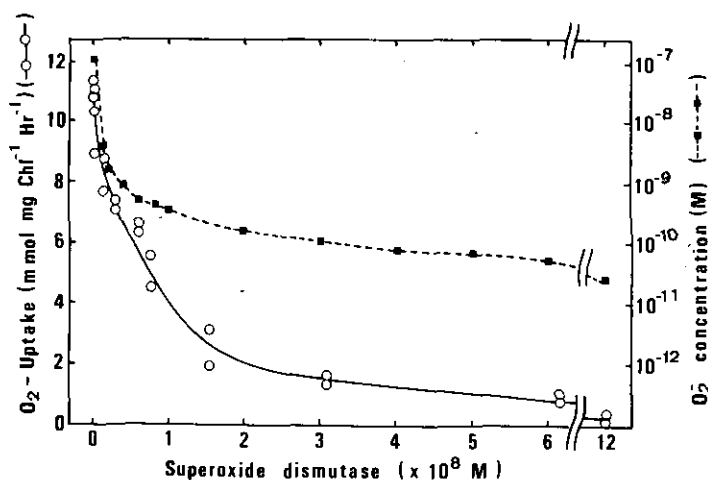

Fig. 6. Effect of superoxide dismutase on sulfite photo-oxidation by spinach chloroplasts. Reaction conditions were the same as in Fig. 5 except that Cu,Zn-superoxide dismutase was added as indicated. The steady state concentration of  $\text{O}_2^-$  in the reaction mixture is estimated assuming that the production rate of  $\text{O}_2^-$  by chloroplasts is  $15 \mu\text{mol mg Chl}^{-1} \text{ hr}^{-1}$  (6) ( $6.3 \times 10^{-9} \text{ M s}^{-1}$  in the present system,  $\nu$  in eq. (9)) and  $k_{sp}$  and  $k_{SOD}$  in eq. (9) are  $5 \times 10^5$  and  $2 \times 10^9 \text{ M}^{-1} \text{ s}^{-1}$ , respectively. (Asada and Kiso (1973) (5)).

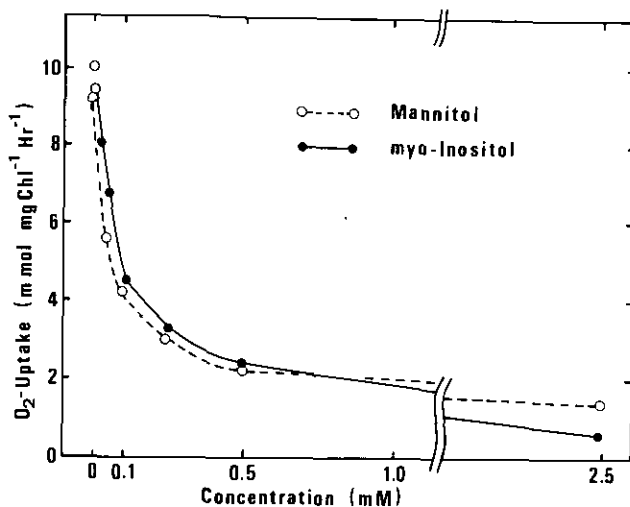

Fig. 7. Effect of sugars on sulfite photo-oxidation by spinach chloroplasts. Reaction conditions were the same as in Fig. 5 except that sugars were added as indicated. Concentration for the half-inhibition of sulfite photo-oxidation; mannitol, 0.070 mM; myo-inositol, 0.095 mM; sorbitol, 0.15 mM; mannose, 0.1 mM and fructose, 0.2 mM. (Asada and Kiso (1973) (5)).

scavenger for  $\text{OH}\cdot$ , inhibits effectively the chloroplast-induced oxidation of sulfite (Fig. 7). The other sugars including myo-inositol, sorbitol, mannose and fructose, also work as inhibitors (5). When NADP and ferredoxin are added to chloroplasts the oxidation rate of sulfite is decreased by the decrease in the production rate of  $\text{O}_2^-$  due to competition between ferredoxin and  $\text{O}_2$  for the primary electron acceptor in photosystem I (5).

The most prominent feature of this reaction, in respect to cell toxicity, is the amplified production of active oxygen,  $\text{O}_2^-$  and  $\text{OH}\cdot$ , and of  $\text{HSO}_3$  radical during the oxidation. In comparison with  $\text{O}_2^-$ ,  $\text{OH}\cdot$  is more reactive with cell components (1, 16). When chloroplasts fail to stop the chain oxidation of sulfite in sulfur dioxide-exposed leaves the production of the reactive radicals is amplified and results in the injury of chloroplasts and of leaf tissues.

### III. Superoxide dismutases in chloroplasts

As shown above superoxide dismutase inhibits the chain oxidation of sulfite by scavenging  $\text{O}_2^-$ , thus, superoxide dismutase is one of the tolerance mechanism of leaf cells against sulfur dioxide. Superoxide dismutase has been classified into three groups on the basis of the metal in the enzyme; Cu,Zn-, and Fe- and Mn-containing enzymes. Land plants contain only the Mn- and Cu,Zn-enzymes. Algae lack the Cu,Zn-enzyme, but, contain the Mn- and Fe-enzymes. For distribution of three types of superoxide dismutase in other organisms, see a review (4). In this section, the kind and concentration of superoxide dismutase in chloroplasts are described; the scavenging capacity by the enzyme and by the other components in chloroplasts follows in the next section. Figure 8 shows the intracellular distribution profile of superoxide dismutase in spinach leaves

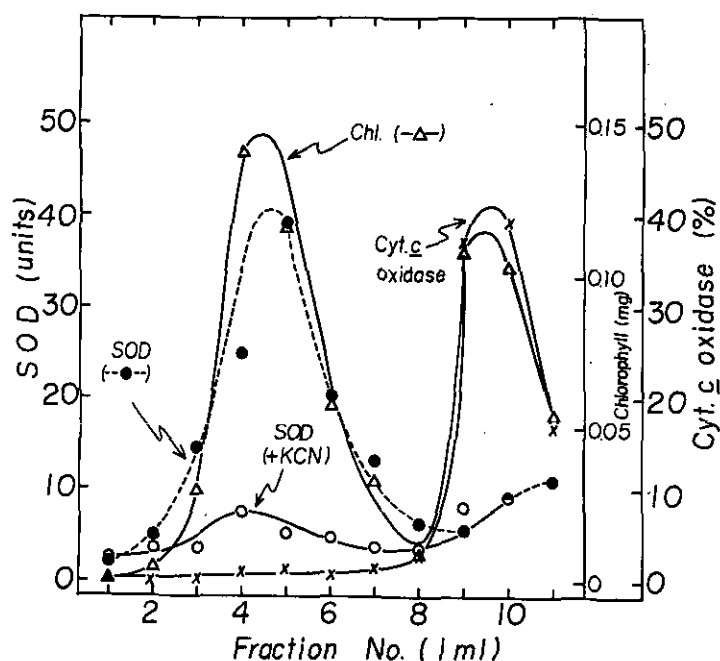

Fig. 8. Subcellular distribution of superoxide dismutase in spinach leaves. Spinach leaves were homogenized in three volumes of a grinding medium consisted of 0.33 M sorbitol, 1 mM EDTA, 1 mM  $MgCl_2$ , 50 mM Tricine-KOH, pH 7.8, and 0.5% bovine serum albumin using a Waring blender for 3 s. The crude intact chloroplast fraction was obtained by centrifugation at 1700 g for 1 min after filtration through eight layers of gauze and was suspended in a small volume of the grinding medium. The suspension (1 ml) was immediately layered onto 10 ml of the linear Percoll (Pharmacia Fine Chemicals) gradient (10–90%, v/v) containing 0.33 M sorbitol, 1 mM  $MgCl_2$ , 1 mM EDTA, 50 mM Tricine-KOH, pH 7.8, and 1% bovine serum albumin and centrifuged at 5000 g for 15 min. Superoxide dismutase activity was assayed in the xanthine-xanthine oxidase-cytochrome c system containing 1% Triton X-100 in the presence and absence of 1 mM KCN. (Kanematsu, Hayakawa and Asada, unpublished)

which has been fractionated by silica sol density centrifugation (24). This fractionation allows the separation of mitochondria and intact chloroplasts that have an envelope. The present results confirm the previous findings showing the location of superoxide dismutase in chloroplasts (9). However, because of intactness of chloroplasts, the content of superoxide dismutase is about three fold higher than in class II chloroplasts (24). No superoxide dismutase is detectable in leaf peroxisomes (9).

Further fractionation of spinach chloroplasts into stroma and thylakoid fractions shows the occurrence of superoxide dismutase in both fractions. The stroma enzyme is inhibited by cyanide, but, the thylakoid enzyme is inhibited only by half to one third. Since only Cu,Zn-superoxide dismutase is sensitive to cyanide, these observations show that the stroma enzyme is the Cu,Zn-enzyme and the thylakoid enzyme is composed of the Cu,Zn- and Mn-enzymes. The Mn- and Fe-superoxide dismutases are distinguished by sensitivity to  $H_2O_2$ ; the Fe-enzyme is inactivated by  $H_2O_2$  but the Mn-enzyme is not

affected (10). The cyanide-insensitive activity in thylakoids is resistant to the treatment with  $H_2O_2$ . This provides an additional evidence for the binding of Mn-superoxide dismutase to thylakoids. The binding of the Mn-enzyme is also found in blue-green algae (34) and in *Euglena* (23). Thus, the thylakoid-bound superoxide dismutase is the Mn-enzyme in photosynthetic organisms including prokaryotic and eukaryotic algae and land plants. However, the cytosol-enzyme in blue-green algae and the stroma-enzyme in *Euglena* are Fe-superoxide dismutase, in contrast to the Cu,Zn-enzyme in the stroma of spinach chloroplasts.

Full activity of the thylakoid-bound enzyme is detectable only after the treatment of the thylakoids with detergent such as Triton (23, 24, 34). This is probably due to the diffusion-controlled reaction rate of  $O_2^-$  with superoxide dismutase. The release of the enzyme from thylakoid membranes may increase the chance of reacting with  $O_2^-$ .

The content of superoxide dismutase in intact chloroplasts shown in Fig. 8 is about 100 (McCord-Fridovich) units  $mg$  chlorophyll $^{-1}$ , in which about 10% is the cyanide-insensitive Mn-enzyme. These values correspond to 0.94 molecule of Cu,Zn-superoxide dismutase and 0.09 molecule of Mn-superoxide dismutase for 1000 molecules of chlorophyll assuming specific activities of 3000 and 2500 units  $mg$  protein $^{-1}$  and molecular weights of 32000 and 40000 of the Cu,Zn- and Mn-enzymes, respectively. Assuming the concentration of chlorophyll in intact chloroplasts is  $2.5 \times 10^{-2} M$  (33), then the concentration of the enzyme in chloroplasts can be estimated from the molar ratio of superoxide dismutase and chlorophyll giving values of  $2.1 \times 10^{-5} M$  for the Cu,Zn-enzyme and  $2.3 \times 10^{-6} M$  for the Mn-enzyme. Since Mn-superoxide dismutase localizes in thylakoids the concentration of the Mn-enzyme in thylakoids is similar to that of the Cu,Zn-enzyme in the stroma if the volume of thylakoids is about 10% of that of intact chloroplasts. Thus, it may be reasonable to conclude that the intact spinach chloroplasts contain superoxide dismutase at about  $2 \times 10^{-5} M$  throughout thylakoids and stroma.

The biosynthesis of superoxide dismutase is induced under conditions that the production of  $O_2^-$  in cells is increased. Exposure of *Escherichia coli* (19), *Streptococcus faecalis* (19), *Photobacterium leiognathi* (35), yeast (20) and rat (37) to air or to  $O_2$  at high concentration results in the increased accumulation of superoxide dismutase. In *Euglena* cultured under photoautotrophic conditions the enzyme content is higher than that in cells cultured under heterotrophic conditions (3), which reflects the formation of  $O_2^-$  under the light in chloroplasts. The induction of superoxide dismutase biosynthesis in *E. coli* has been observed with the addition of paraquat (22), that is reduced in the cells and, by the autooxidation of the reduced paraquat cation radicals,  $O_2^-$  is produced at a rapid rate ( $7.7 \times 10^8 M^{-1} s^{-1}$ ) (13).

In plants the induction of the enzyme by the exposure to sulfur dioxide has been shown (see No. 15 paper in this issue). This suggests that the production of  $O_2^-$  in chloroplasts is increased by sulfur dioxide-exposure, as discussed in II. In addition to the adaptive formation of superoxide dismutase, the content of the enzyme in leaves is affected by their age (8). This may infer why the tolerance of leaves to sulfur dioxide is varied by their age.

#### IV. Scavenging of superoxide in chloroplasts

The superoxide radicals in aqueous solution mainly work as a reductant and a oxidant (40). Its disproportionation is the internal oxidation-reduction reaction (eq. (1))



and is the major scavenging pathway in chloroplasts. First, spontaneous and enzyme-catalyzed disproportionation of  $O_2^-$  is estimated.

In a steady state the production rate of  $O_2^-$  ( $\nu$ ) is equal to its disappearance rate, thus;

$$\nu = k_{sp} [O_2^-]^2 + k_{SOD} [O_2^-] [SOD] + k_{Oxi-Red} [A \text{ or } AH] [O_2^-] \quad (9)$$

The first term represents the spontaneous disproportionation and the second term the superoxide dismutase(SOD)-catalyzed disproportionation.  $k_{sp}$  is the second order reaction rate constant between  $O_2^-$  and  $O_2^-$ , and  $k_{SOD}$  is that between  $O_2^-$  and superoxide dismutase. For the third term, see below.

Since  $pKa$  of superoxide is 4.88, in neutral pH most of superoxide occur in a form of  $O_2^-$  and  $HO_2$  is a minor molecular species. On the other hand,  $k_{sp}$  for the spontaneous disproportionation between  $HO_2$  and  $HO_2$ , between  $HO_2$  and  $O_2^-$ , and between  $O_2^-$  and  $O_2^-$  are  $8.6 \times 10^5$ ,  $1.02 \times 10^8$  and  $< 0.35 \text{ M}^{-1} \text{ s}^{-1}$ , respectively (11). Therefore,  $k_{sp}$  is largely affected by pH; it is the highest at pH of  $pKa$  of superoxide and decreases by a factor of 10 with an increase of each pH unit. At pH 7.0,  $k_{sp}$  is about  $5 \times 10^5 \text{ M}^{-1} \text{ s}^{-1}$  and at higher pH the life of superoxide becomes longer, due to slow disproportionation by electrostatic repulsion of  $O_2^-$  and by low concentration of  $H^+$ . The steady state

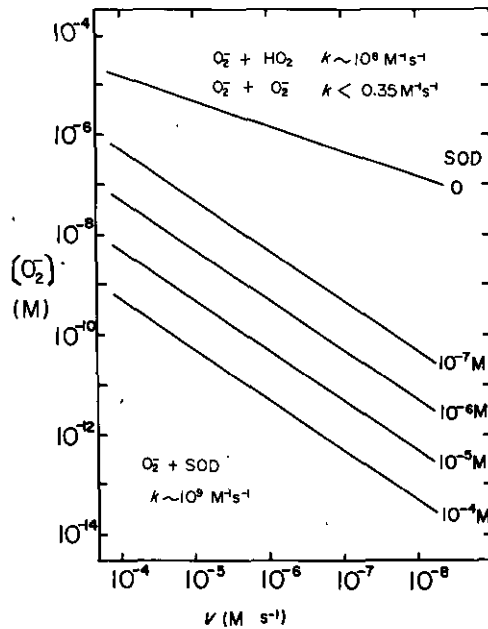

Fig. 9. The steady state concentration of superoxide in a reaction mixture at various production rates of superoxide ( $\nu$ ) and various concentrations of superoxide dismutase (SOD) at pH 7.0.  $k_{sp}$  and  $k_{SOD}$  in eq. (9) are assumed to be  $5 \times 10^5$  and  $2 \times 10^9 \text{ M}^{-1} \text{ s}^{-1}$ , respectively.

Table 2 *Reactivity of chloroplast components with O<sub>2</sub><sup>-</sup>, their reaction rate constants and concentrations in chloroplasts*

Reaction with O <sub>2</sub> <sup>-</sup> (A or AH)	Reaction rate constants ( <i>k</i> <sub>Oxi-Red</sub> , M <sup>-1</sup> s <sup>-1</sup> )	Concentration in chloroplasts <sup>a)</sup> (M)
Cytochrome <i>f</i> (Fe <sup>3+</sup> → Cytochrome <i>f</i> (Fe <sup>2+</sup> ))	6.1 × 10 <sup>6</sup> (pH 7.8) (38)	6.2 × 10 <sup>-5</sup> b,c)
Plastocyanin (Cu <sup>2+</sup> ) → Plastocyanin (Cu <sup>+</sup> )	1.1 × 10 <sup>6</sup> (pH 7.8) (26)	6.2 × 10 <sup>-5</sup> b,c)
Ferredoxin (Fe <sup>3+</sup> ) → Ferredoxin (Fe <sup>2+</sup> )	—	6.2 × 10 <sup>-5</sup> b,c)
Mn <sup>2+</sup> → Mn <sup>3+</sup>	6.0 × 10 <sup>6</sup> (pH 7.8) (27)	4.0 × 10 <sup>-4</sup> (27) <sup>c)</sup>
Ascorbate → (Dehydroascorbate)	6.7 × 10 <sup>5</sup> (pH 7.3) (32)	2.5 × 10 <sup>-3</sup> (18)
Reduced glutathione → Oxidized glutathione	6.7 × 10 <sup>5</sup> (pH 7.8) (2)	3.5 × 10 <sup>-3</sup> (14)

- a) These values are not local concentration in thylakoids or stroma but an average concentration in intact chloroplasts. Local concentrations of cytochrome *f*, plastocyanin and ferredoxin in thylakoids would be 10-fold these values.  
 b) Estimated assuming that the content is 1 molecule for 400 molecules of chlorophyll.  
 c) Estimated assuming that concentration of chlorophyll in intact chloroplasts is 2.5 × 10<sup>-2</sup> M (33).

concentration of superoxide is estimated using eq. (9), when superoxide dismutase and other scavengers are absent, and the results at pH 7 is presented in Fig. 9 at various production rates of O<sub>2</sub><sup>-</sup>.

In contrast to spontaneous disproportionation, *k*<sub>SOD</sub> is independent of pH in a range of 5 to 9; about 2 × 10<sup>9</sup> M<sup>-1</sup> s<sup>-1</sup>, but, the catalysis rates of Fe- and Mn-superoxide dismutases decrease above pH 8 (1, 15). The steady state concentration of O<sub>2</sub><sup>-</sup> in the presence of various concentrations of superoxide dismutase is estimated at various production rates of O<sub>2</sub><sup>-</sup> (Fig. 9), using eq. (9) and neglecting the first and third terms. Spontaneous disproportionation is second order in O<sub>2</sub><sup>-</sup>, but, superoxide dismutase-catalyzed disproportionation is first order in respect of O<sub>2</sub><sup>-</sup> and of the enzyme. This is the reason why the concentration of O<sub>2</sub><sup>-</sup> is more effectively decreased by the enzyme when the production rate of O<sub>2</sub><sup>-</sup> is low.

As described in III spinach chloroplasts contain 2 × 10<sup>-5</sup> M superoxide dismutase. When the production rate of O<sub>2</sub><sup>-</sup> is 1.3 × 10<sup>-4</sup> M s<sup>-1</sup>, about 10% of the capacity of electron transport in chloroplasts (see, I), the steady state concentration of O<sub>2</sub><sup>-</sup> is calculated to be 3.3 × 10<sup>-9</sup> M. Under the same conditions, if superoxide dismutase is absent, the steady state concentration is estimated to be 1.6 × 10<sup>-5</sup> M. Thus, superoxide dismutase in chloroplasts, lowers the concentration of O<sub>2</sub><sup>-</sup> by about 10<sup>-4</sup>.

In addition to superoxide dismutase, the chloroplast components in Table 2 are oxidized or reduced by O<sub>2</sub><sup>-</sup> (the third term in eq. (9)). Their reaction rate constants (*k*<sub>Oxi-Red</sub> in eq. (9)) with O<sub>2</sub><sup>-</sup> and their concentrations in chloroplasts are also included in the Table. These values indicate that the contribution of these reactions to the scavenging of O<sub>2</sub><sup>-</sup> in chloroplasts is about 10% of that by superoxide dismutase, even if these components occur in an oxidized or reduced form which is reactive with O<sub>2</sub><sup>-</sup>. However, plastocyanin, cytochrome *f* and ferredoxin bind to thylakoids and their local

concentrations is high. Therefore, under specific conditions where these proteins occur in reduced (ferredoxin) or oxidized (cytochrome *f* and plastocyanin) form, their participation in the scavenging of  $O_2^-$  can not be neglected. A preliminary evidence showing that  $O_2^-$  is an electron donor to photosystem I has been presented (30).

#### V. Concluding remarks

The formation of  $O_2^-$  is an unavoidable reaction when an electron acceptor is not available for chloroplasts. Even when physiological electron acceptor,  $CO_2$ , is sufficiently supplied to chloroplasts  $O_2^-$  is produced to form ATP by pseudocyclic photophosphorylation. Under normal states, photoproduced- $O_2^-$  is scavenged mainly by superoxide dismutase in chloroplasts, as discussed in IV, and no apparent damage to leaf tissues is observed.

When leaves are exposed to sulfur dioxide the dissolved pollutant comes in contact with chloroplasts even though several mechanisms such as stomata closure (see No. 12 paper in this issue) work to prevent its absorption. Oxidation of sulfite may be initiated under conditions where the steady state concentration of  $O_2^-$  is high through enhanced production of  $O_2^-$  (see, I) and/or low scavenging capacity of  $O_2^-$  (see, IV). Once the chain oxidation is initiated the production of cytotoxic  $O_2^-$ ,  $OH\cdot$  and  $HSO_3\cdot$  is increased and these radicals oxidize chloroplast membranes. The estimated concentration of  $O_2^-$  at various concentrations of superoxide dismutase is included in Fig. 6; the chain oxidation of sulfite is remarked above  $10^{-9} \sim 10^{-10}$  M. As discussed in IV, if 10% of chloroplast reducing power is used for  $O_2^-$ -production then the steady state concentration of  $O_2^-$  is about  $10^{-9}$  M in chloroplasts containing  $2 \times 10^{-5}$  M superoxide dismutase. Thus, in respect of  $O_2^-$ , chloroplasts initiate the oxidation of sulfite under light conditions when the  $CO_2$ -supply to chloroplasts is limited and when more than 10% of the reducing power is used for the production of  $O_2^-$ . In addition, the scavenger of the hydroxyl radicals, the sugars in chloroplasts, may offer another important defense from injury by sulfur dioxide (Fig. 7).

#### References

1. Asada, K.: Oxygen toxicity. *Seikagaku* 48: 226-257 (1976).
2. Asada, K. and S. Kanematsu: Reactivity of thiols with superoxide radicals. *Agric. Biol. Chem.* 40: 1891-1892 (1976).
3. Asada, K., S. Kanematsu and K. Uchida: Superoxide dismutases in photosynthetic organisms: Absence of the cuprozinic enzyme in eukaryotic algae. *Arch. Biochem. Biophys.* 179: 243-256 (1977).
4. Asada, K. and S. Kanematsu: Distribution of cuprozinic, manganic, and ferric superoxide dismutases in plants and fungi; An evolutionary aspect. In *Evolution of Protein Molecules*: Edited by H. Matsubara and T. Yamanaka. p.361-372. Japan Scientific Societies Press, Tokyo, 1978.
5. Asada, K. and K. Kiso: Initiation of aerobic oxidation of sulfite by illuminated spinach chloroplasts. *Eur. J. Biochem.* 33: 253-257 (1973).
6. Asada, K., K. Kiso and K. Yoshikawa: Univalent reduction of molecular oxygen by spinach chloroplasts on illumination. *J. Biol. Chem.* 249: 2175-2181 (1974).
7. Asada, K. and Y. Nakano: Affinity for oxygen in photoreduction of molecular oxygen and scavenging of hydrogen peroxide in spinach chloroplasts. *Photochem. Photobiol.* 28: 917-920 (1978).
8. Asada, K., M. Takahashi, T. Tanaka and Y. Nakano: Formation of active oxygen and its fate in chloroplasts. In *Biochemical and Medical Aspects of Active Oxygen*. Edited by O. Hayaishi and K. Asada. p. 45-63. Japan Scientific Societies Press, Tokyo, 1977.
9. Asada, K., M. Urano and M. Takahashi: Subcellular location of superoxide dismutase in spinach

- leaves and preparation and properties of crystalline spinach superoxide dismutase. *Eur. J. Biochem.* 36: 257-266 (1973).
10. Asada, K., K. Yoshikawa, M. Takahashi, Y. Maeda and K. Enmanji: Superoxide dismutases from a blue-green alga, *Plectonema boryanum*. *J. Biol. Chem.* 250: 2801-2807 (1975).
  11. Bielski, B. H. J.: Reevaluation of the spectral and kinetic properties of  $\text{HO}_2$  and  $\text{O}_2^-$  free radicals. *Photochem. Photobiol.* 28: 645-649 (1978).
  12. Egneus, H., U. Heber, U. Mathiesen and M. Kirk: Reduction of oxygen by the electron transport chain of chloroplasts during assimilation of carbon dioxide. *Biochim. Biophys. Acta* 408: 252-268 (1975).
  13. Farrington, J. A., M. Ebert, E. J. Land and K. Fletcher: Bipyridylum quaternary salts and related compounds. V. *Biochim. Biophys. Acta* 314: 372-381 (1973).
  14. Foyer, C. H., and B. Halliwell: The presence of glutathione and glutathione reductase in spinach chloroplasts: A proposed role in ascorbic acid metabolism. *Planta* 133: 21-25 (1976).
  15. Fridovich, I.: Superoxide dismutases. *Annu. Rev. Biochem.* 44: 147-159 (1975).
  16. Fridovich, I.: The biology of oxygen radicals. *Science* 201: 875-880 (1978).
  17. Fridovich, I. and P. Handler: Detection of free radicals generated during enzymatic oxidations by the initiation of sulfite oxidation. *J. Biol. Chem.* 236: 1836-1840 (1961).
  18. Gerhardt, B.: Untersuchungen über Beziehung zwischen Ascorbinsäure und Photosynthese. *Planta* 61: 101-129 (1964).
  19. Gregory, E. M. and I. Fridovich: Induction of superoxide dismutase by molecular oxygen. *J. Bacteriol.* 144: 543-548 (1973).
  20. Gregory, E. M., S. A. Goscin and I. Fridovich: Superoxide dismutase and oxygen toxicity in a eukaryote. *J. Bacteriol.* 117: 456-460 (1974).
  21. Halliwell, B.: The chloroplast at work. A review of modern development in our understanding of chloroplast metabolism. *Prog. Biophys. Molec. Biol.* 33: 1-54 (1978).
  22. Hassan, H. M. and I. Fridovich: Regulation of the synthesis of superoxide dismutase in *Escherichia coli*. Induction by methyl viologen. *J. Biol. Chem.* 252: 7667-7672 (1977).
  23. Kanematsu, S. and K. Asada: Ferric and manganic superoxide dismutases in *Euglena gracilis*. *Arch. Biochem. Biophys.* 195: 535-545 (1979).
  24. Kanematsu, S., T. Hayakawa and K. Asada: unpublished.
  25. Ke, B.: The primary electron acceptor of photosystem I. *Biochim. Biophys. Acta* 301: 1-33 (1973).
  26. Kono, Y., M. Takahashi and K. Asada: Reduction of plastocyanin by  $\text{O}_2^-$ . *Seikagaku* 47: 336 (1975).
  27. Kono, Y., M. Takahashi and K. Asada: Oxidation of manganous pyrophosphate by superoxide radicals and illuminated spinach chloroplasts. *Arch. Biochem. Biophys.* 174: 454-462 (1976).
  28. Lien, S. and A. San Pietro: On the reactivity of oxygen with photosystem I electron acceptors. *FEBS Letters* 99: 189-193 (1979).
  29. Mehler, A. H.: Studies on reactions of illuminated chloroplasts. I. Mechanism of the reduction of oxygen and Hill reagents. *Arch. Biochem. Biophys.* 33: 65-77 (1951).
  30. Muallem, A. and S. Malkin: Anomalous oxygen uptake from isolated chloroplasts inhibited in photosystem II and without external electron donors. *Biochim. Biophys. Acta* 546: 175-182 (1979).
  31. Nakano, Y. and K. Asada: unpublished.
  32. Nishikimi, M.: Oxidation of ascorbic acid with superoxide anion generated by the xanthine-xanthine oxidase system. *Biochem. Biophys. Res. Commun.* 63: 463-468 (1975).
  33. Nobel, P.S.: *Introduction to Biophysical Plant Physiology*. p.201. Freeman Co., San Francisco. 1974.
  34. Okada, S., S. Kanematsu and K. Asada: Intracellular distribution of manganic and ferric superoxide dismutases in blue-green algae. *FEBS Letters* 103: 106-110 (1979).
  35. Puget, K. and A. M. Michelson: Isolation of a new copper-containing superoxide dismutase, bactericuprein. *Biochem. Biophys. Res. Commun.* 58: 830-838 (1974).
  36. Radmer, R. J. and B. Kok: Photoreduction of  $\text{O}_2$  primes and replaces  $\text{CO}_2$  assimilation. *Plant Physiol.* 58: 336-340 (1976).
  37. Stevens, J. B. and A. P. Autor: Induction of superoxide dismutase by oxygen in neonatal rat lung. *J. Biol. Chem.* 252: 3509-3514 (1977).
  38. Tanaka, K., M. Takahashi and K. Asada: Isolation of monomeric cytochrome *f* from Japanese

Superoxide and sulfur dioxide-injury in plants

- radish and a mechanism of autoreduction. *J. Biol. Chem.* 253: 7397-7403 (1978).
39. Tuazon, P. T. and S. L. Johnson: Free radical and ionic reactions of bisulfite with nicotinamide adenine dinucleotide and its analogues. *Biochemistry* 16: 1183-1188 (1977).
  40. Wilshire, J. and D. T. Sawyer: Redox chemistry of dioxygen species. *Acc. Chem. Res.* 12: 105-110 (1979).
  41. Yang, S. F.: Sulfoxide formation from methionine or its sulfite analogs during aerobic oxidation of sulfite. *Biochemistry* 9: 5008-5014 (1970).

## Analysis of air pollutant sorption by plants

### (1) Relation between local SO<sub>2</sub> sorption and acute visible leaf injury

Kenji Omasa and Fumiaki Abo

Division of Engineering, The National Institute for Environmental Studies, Yatabe, Ibaraki 305

In order to investigate the relation between the SO<sub>2</sub> sorption into the leaves and plant resistance to SO<sub>2</sub>, a problem in visible leaf injury, varying according to its location on the leaf, was taken up and examined under controlled-environment conditions. The results obtained were as follows.

(1) An equation for the relation between  $Q/w'$  and  $P_{as}$  was obtained as  $Q/w' \approx 1.8 \times 10^{-3} P_{as}$ , where  $w'$  was transpiration rate divided by the water vapor pressure differences between gas-liquid interface in the leaf and the atmosphere,  $Q$  was SO<sub>2</sub> sorption rate and  $P_{as}$  was atmospheric SO<sub>2</sub> concentration. The result agrees with the equation which is obtained by a model,  $Q/w' = (k_w/k_s k_r) (P_{as} - P_{ls})$  with  $P_{ls} = 0$  volppm and  $k_r = 1.53$ , where  $P_{ls}$  is SO<sub>2</sub> concentration at gas-liquid interface in the leaf,  $k_r$  is the ratio of SO<sub>2</sub> diffusive resistance to water vapor diffusive resistance,  $k_w$  is a constant,  $1.06 \times 10^6$  mmHg·cm<sup>3</sup>·g<sup>-1</sup>, and  $k_s$  is a constant,  $3.95 \times 10^8$  volppm·cm<sup>3</sup>·g<sup>-1</sup>.

(2) Relation between leaf-air temperature difference and transpiration rate was obtained as a linear equation during SO<sub>2</sub> fumigation under controlled conditions in the experimental chamber, the regression coefficient was  $-5.8 \times 10^5$  cm<sup>2</sup>·s<sup>-1</sup>·°C<sup>-1</sup>. According to the results, the local transpiration rate, indicating the degree of stomatal aperture, may be estimated by measuring leaf temperature. Thus the SO<sub>2</sub> sorption rate can be estimated from leaf temperature.

(3) A close relation was noted between the degree of visible leaf injury at various sites on the leaf and changes in leaf temperature at these sites. That is, there was a tendency for the degree of injury to be greater at sites with a slower increase in leaf temperature. This is probably because the rate of stomatal closure is slower at sites with a slow increase in leaf temperature and therefore, the amount of SO<sub>2</sub> sorption is higher than at sites having a rapid increase in leaf temperature.

**Key words:** SO<sub>2</sub> sorption—Leaf injury—Leaf temperature.

The degree of air pollutant injury to plants has been frequently discussed in relation to factors, such as the concentration and the dose, that relate to the amount of sorption (7, 9, 14, 15). However, the leaf boundary layer, stomatal aperture and the nature of the gas-liquid interface in the substomatal cavity are also important factors governing the mass transfer and may be thought to contribute to air pollutant injury. In particular, the variance in these factors may be striking when the species, age, site of the leaf and leaf position are dissimilar. Therefore, the effect of these factors in relation to leaf injury

should be examined.

It is known that boundary layer or stomatal resistance to diffusion of air pollutants to leaves may be treated, by the mass transfer analogy, in the same way as the diffusion of water vapor or CO<sub>2</sub> (1, 8, 16). There are a few reports relate to such boundary conditions as the nature of leaf surface. Hill (6) and Bennet et al. (1) have reported on the relation between the sorption of air pollutants by plants and solubility in water. Spedding (13) reported on differences in the rate of sorption of pollutants depending on differences in the materials comprising the surface. There is a report by Fowler and Unsworth (2) regarding differences in sorption rates depending on differences in leaf surfaces. However, no report has come to light as a measured boundary condition of the leaf surface until injury occurs. In general, surface boundary conditions vary according to the solubility of the object pollutant, transport within the plant body, metabolic activity, buffer capacity, etc., and require experimental investigation.

Our research is intended to resolve unclear points in mechanisms of sorption of pollutants by plants and to elucidate the relation between the various factors concerning the sorption of pollutants and plant resistance. In the present report we have sought experimentally to determine the relation between SO<sub>2</sub> sorption and transpiration rates of the leaf until injury occurs to the leaf. We also attempted analysis of concentration boundary conditions on the surface in the substomatal cavity over a period of time, using simple models. In addition, we investigated the factors contributing to acute visible injury occurring locally on the leaf using the above mentioned results.

## Materials and methods

### Materials

Sunflower (*Helianthus annuus* L. cv. Russian Mammoth) plants were used as experimental materials. The plants were grown in the Phytotron (daytime: 25°C; nighttime: 20°C; 70%RH; natural light) for 4–5 weeks (1000–2500 cm<sup>2</sup> leaf area/plant and 10–20 leaves/plant) after planting in pots (10 cm in diameter, 20 cm high) which were filled with a mixture of vermiculite, perlite, peat moss and fine gravel at the ratio 2:2:1:1 (v/v).

### Equipment

An environmental chamber for exposure to gaseous pollutants (effective capacity: 2.3 (W) × 1.7(D) × 1.9(H); m<sup>3</sup>) was used for this research (10). The equipment employs Yoko lamp (Toshiba) as light source; infrared rays above approximately 800 nm were removed by means of glass filters with phosphoric acid containing ferric oxide. The intensity of illumination 1.3 m beneath the light source was 40±5 klux when all lamps were on. Temperature, humidity and SO<sub>2</sub> concentration were controlled below ± 0.5°C, ± 3%RH and ± 0.04 volppm respectively. The average wind velocity inside the chamber was 0.22 m·s<sup>-1</sup> (standard deviation: 0.05 m·s<sup>-1</sup>). The concentration of SO<sub>2</sub> was determined by measuring the intensity of its fluorescence in the 300–390 nm range under excitation by ultraviolet rays in the 190–230 nm range.

### Measuring methods

The SO<sub>2</sub> sorption rate of the plants was measured as follows: A standard gas with a constant concentration was supplied to the chamber at a constant flow rate. After the gas concentration inside the chamber was constant, 10 sunflower plants were placed in the chamber and the sorption rate was measured from the subsequent change in gas

concentration inside the chamber. With this method 15–30 minutes are required after placing the sunflower plants in the chamber to stabilize conditions. To enhance the precision of the experiment, the SO<sub>2</sub> was supplied from a tank with a known concentration and regulated by a mass flow controller. Also, air temperature and humidity within the chamber were controlled solely with an electric heater and humidifier in order to eliminate any influence of cooling and dehumidifying coils on SO<sub>2</sub> concentration. The transpiration rate was measured by the weighing method with a recording balance. The leaf temperature was measured by a copper-constantan thermocouple of 0.1 mm diameter.

#### *Experiment methods*

**Experiment I** – Simultaneous measurement of leaf-air temperature difference and transpiration rate during SO<sub>2</sub> fumigation:

Leaf-air temperature difference and transpiration rate were measured simultaneously for a sunflower plant during SO<sub>2</sub> fumigation. Leaf-air temperature differences were measured by attaching six thermocouples each to the upper and lower surfaces of a leaf. In this case, leaves were removed from the plant except those in the fifth and sixth leaf position and the patterns of changes in leaf-air temperature differences measured by 24 thermocouples were nearly uniform.

**Experiment II** – Simultaneous measurement of rates of SO<sub>2</sub> sorption and transpiration:

Changes in the total rates of SO<sub>2</sub> sorption and transpiration were measured simultaneously for 10 sunflower plants fumigated with 0.2–1.5 volppm SO<sub>2</sub> for 5 hours. Leaf temperatures were measured at random directly from the upper or lower surfaces of leaves prior to SO<sub>2</sub> fumigation and an average temperature for the 10 plants was calculated.

**Experiment III** – Measurement of local temperature changes on the leaf during SO<sub>2</sub> fumigation and assessment of the degree of acute visible leaf injury:

Leaf-air temperature differences in various sites of the leaf during SO<sub>2</sub> fumigation were measured. The degree of visible leaf injury revealed in the various sites following SO<sub>2</sub> fumigation was also assessed. Leaf temperature was measured by attaching six thermocouples to the upper surface of leaves, respectively. The degree of injury to plants fumigated with SO<sub>2</sub> for 2 hours was assessed 20 hours later by measuring the proportion of the surface area that had suffered visible leaf injury within a circle 1 cm in diameter adjacent to the point of attachment of the thermocouples. These test circles were divided into three categories: those in which visible leaf injury was entirely absent, represented by (–); those in which 0 to 1/2 of the total surface area had visible leaf injury, represented by (+); and those in which 1/2 to all of the total surface area had visible leaf injury, represented by (++) .

### **Experimental results and discussion**

#### *Nomenclature*

<i>E</i>	: Net radiation on the leaf	cal · cm <sup>-2</sup> · s <sup>-1</sup>
<i>S</i>	: Sensible heat by convection on the leaf	cal · cm <sup>-2</sup> · s <sup>-1</sup>
<i>L</i>	: Latent heat by evaporation	cal · g <sup>-1</sup>
<i>W</i>	: Transpiration rate on the leaf	g · cm <sup>-2</sup> · s <sup>-1</sup>



$\alpha_p$	: Coefficient of absorption of shortwave radiation on the leaf	
$E_s$	: Shortwave radiation on the leaf	$\text{cal}\cdot\text{cm}^{-2}\cdot\text{s}^{-1}$
$E_l$	: Absorption of longwave radiation on the leaf	$\text{cal}\cdot\text{cm}^{-2}\cdot\text{s}^{-1}$
$2\epsilon\sigma T_l^4$	: Longwave radiation from the leaf	$\text{cal}\cdot\text{cm}^{-2}\cdot\text{s}^{-1}$
$\epsilon$	: Coefficient of longwave radiation on the leaf	
$\sigma$	: Stefan-Boltzmann constant ( $1.37 \times 10^{-12}$ )	$\text{cal}\cdot\text{cm}^{-2}\cdot\text{s}^{-1}\cdot^\circ\text{K}^{-4}$
$T_a$	: Air temperature	$^\circ\text{C}, ^\circ\text{K}$
$T_l$	: Leaf temperature	$^\circ\text{C}, ^\circ\text{K}$
$\Delta T$	: Leaf-air temperature difference ( $T_l - T_a$ )	$^\circ\text{C}$
$h_T$	: Coefficient of heat transfer on the leaf	$\text{cal}\cdot\text{cm}^{-2}\cdot\text{s}^{-1}\cdot^\circ\text{C}^{-1}$
$Q$	: $\text{SO}_2$ sorption rate on the leaf	$\text{g}\cdot\text{cm}^{-2}\cdot\text{s}^{-1}$
$k_w$	: Saturated vapor density/pressure conversion coefficient ( $1.06 \times 10^6$ )	$\text{mmHg}\cdot\text{cm}^3\cdot\text{g}^{-1}(35^\circ\text{C})$
$X_s(T)$	: Saturated vapor pressure at $T^\circ\text{C}$	$\text{mmHg}$
$\varphi$	: Relative humidity	
$P_{as}$	: Atmospheric $\text{SO}_2$ concentration	$\text{volppm}$
$P_{ls}$	: $\text{SO}_2$ concentration at the gas-liquid interface in the leaf	$\text{volppm}$
$k_s$	: $\text{SO}_2$ concentration unit conversion coefficient ( $3.95 \times 10^8$ )	$\text{volppm}\cdot\text{cm}^3\cdot\text{g}^{-1}(35^\circ\text{C})$
$r_{wa}$	: Boundary layer resistance to water vapor	$\text{s}\cdot\text{cm}^{-1}$
$r_{ws}$	: Stomatal resistance to water vapor	$\text{s}\cdot\text{cm}^{-1}$
$r_{sa}$	: Boundary layer resistance to $\text{SO}_2$	$\text{s}\cdot\text{cm}^{-1}$
$r_{ss}$	: Stomatal resistance to $\text{SO}_2$	$\text{s}\cdot\text{cm}^{-1}$
$r_b$	: Gas-liquid interface resistance to $\text{SO}_2$	$\text{s}\cdot\text{cm}^{-1}$
$r_a$	: Boundary layer resistance on the leaf	$\text{s}\cdot\text{cm}^{-1}$
$\alpha$	: Coefficient allowing for the tilt, fluttering, etc. of leaves	
$x$	: Distance from the leading edge	$\text{cm}$
$l$	: Characteristic length of a leaf	$\text{cm}$
$Sc$	: Schmidt number	
$Re_x$	: Reynolds number at $x$	
$D$	: Air-gas diffusivity	$\text{cm}^2\cdot\text{s}^{-1}$
$D_s$	: Air- $\text{SO}_2$ diffusivity	$\text{cm}^2\cdot\text{s}^{-1}$
$D_w$	: Air-water vapor diffusivity	$\text{cm}^2\cdot\text{s}^{-1}$
$w'$	: $W/\{X_s(T_l) - \varphi X_s(T_a)\}$	$\text{g}\cdot\text{cm}^{-2}\cdot\text{s}^{-1}\cdot\text{mmHg}^{-1}$

*Relation between leaf-air temperature difference and the transpiration rate during  $\text{SO}_2$  fumigation*

According to Monteith (8) and Gates and Papian (3), the heat balance on the leaf may generally be given by the following equation:

$$E=S+LW \quad (1)$$

In Eq. (1) net radiation  $E$  is

$$E=\alpha_p E_s+E_l-2\epsilon\sigma T_l^4 \quad (2)$$

Analysis of air pollutant sorption by plants (1)

If we assume that absorption  $E_l$  of longwave radiation is black body radiation by the surrounding walls and the temperature is equal to air temperature  $T_a$ , the  $E_l$  become  $2\sigma T_a^4$ . If we further approximate the coefficient of radiation on the leaf at 1.0, the following equation is obtained.

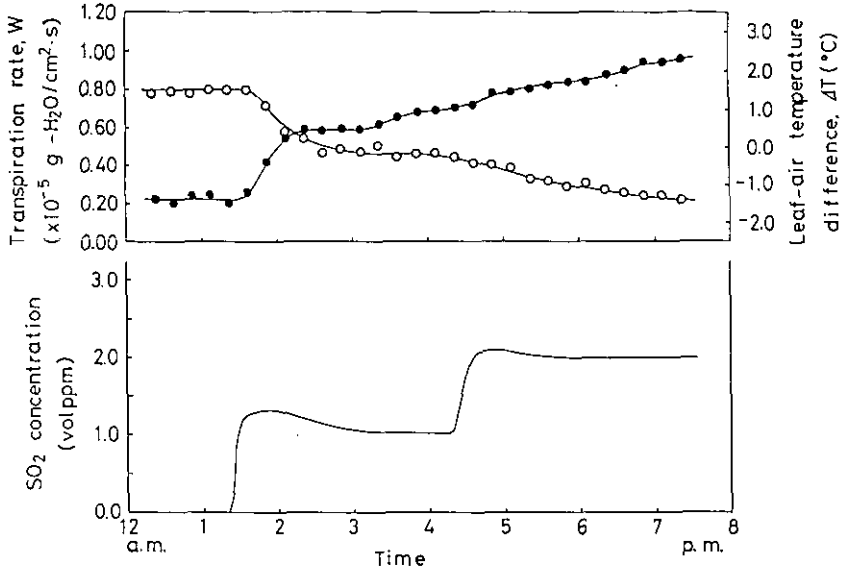

Fig. 1. Time courses of transpiration rate ( $W$ ) (—○—) and leaf-air temperature difference ( $\Delta T$ ) (—●—) during  $SO_2$  fumigation. Air temperature,  $26^\circ C$ ; humidity, 60%RH; light intensity, 40 klux.

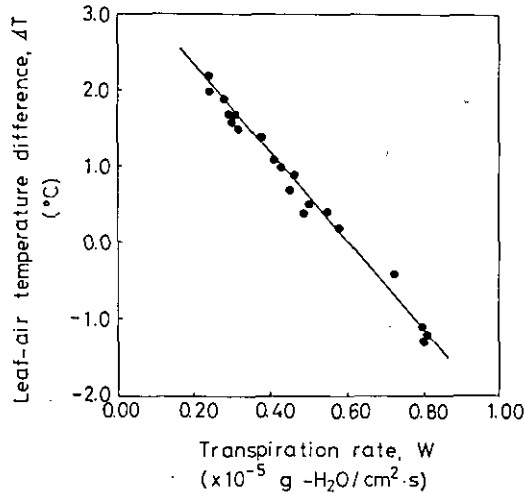

Fig. 2. Relation between transpiration rate ( $W$ ) and leaf-air temperature difference ( $\Delta T$ ). Data were obtained from the results shown in Fig. 1.

$$E = \alpha_p E_s + 2\sigma(T_a^4 - T_l^4) \approx \alpha_p E_s + 8\sigma(T_a - T_l)T_a^3 \quad (3)$$

Sensible heat  $S$  is

$$S = -2h_T(T_a - T_l) \quad (4)$$

As  $(T_l - T_a) = \Delta T$ , a relation between  $\Delta T$  and  $W$  is given by

$$\Delta T = - \left. \frac{L}{(8\sigma T_a^3 + 2h_T)} \right\} W + \alpha_p E_s / (8\sigma T_a^3 + 2h_T) \quad (5)$$

If light intensity, air temperature, humidity and wind velocity within the experimental chamber are assumed to be constant, it may be surmised that  $\Delta T$  and  $W$  will be linearly related.

Fig. 1 gives representative examples of leaf temperature and transpiration rate during fumigation with 1–2 volppm of  $SO_2$  over an 8 hour period. The transpiration rate decreased and the leaf-air temperature difference increased as  $SO_2$  fumigation continued.

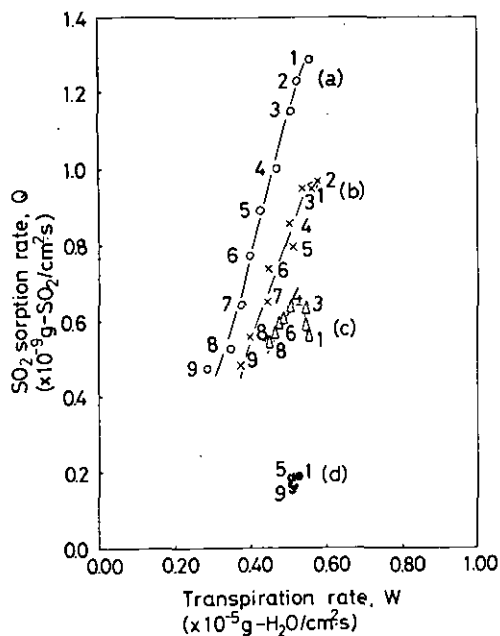

Fig. 3. Relation between  $SO_2$  sorption rate ( $Q$ ) and transpiration rate ( $W$ ) during  $SO_2$  fumigation. The  $SO_2$  concentration is about 1.5 volppm (a), about 1 volppm (b), about 0.65 volppm (c) and about 0.2 volppm (d). The fumigation time (min) is calculated from  $30mf+15$ , where  $mf$  indicates the number in the figure. Air temperature, 35–36 °C; humidity, 65%RH; light intensity, 20 klux.

There are deviations resulting from species variation, variations between individual plants, the ages of the plants, the different leaf positions, etc., but the higher the  $SO_2$  concentration the more striking the phenomenon.

Fig. 2 shows the relation between the leaf-air temperature difference and the transpiration rate obtained from the results shown in Fig. 1. The fact that the results may be expressed by the linear regression  $\Delta T = -5.8 \times 10^5 W + 3.5$  verifies that the linear relation shown in Eq. (5) continues to exist between  $\Delta T$  and  $W$  during  $SO_2$  fumigation.

*The relation between  $SO_2$  sorption rate and transpiration rate*

The relation between the  $SO_2$  sorption rate and the transpiration rate in sunflowers was investigated experimentally in order to study the mechanism of  $SO_2$  sorption in plants (Experiment II). Fig. 3 shows the relation between changes in the rates of  $SO_2$  sorption  $Q$  and transpiration  $W$  for 5 hours of fumigation with  $SO_2$  in four concentrations ranging from 0.2 to 1.5 volppm. The fumigation time is calculated as  $30m_f + 15 \text{ min}$  ( $m_f = 1, 2, 3, \dots$ ), for example  $m_f = 5$  denotes a value equal to a point in time 2 hours and 45 minutes after the onset of fumigation. The phenomenon of  $SO_2$  sorption and transpiration rates both decreasing as fumigation continued is apparent in Fig. 3 for  $SO_2$  concentration of 1 and 1.5 volppm. The decrease was greater at 1.5 volppm than at 1 volppm. The same tendency was apparent at 0.65 volppm as well, but it was not as marked. As for visible leaf injury, water-soaked on the leaf, a precursor of necrosis and chlorosis, and subsequent wilting of leaves were visible at 1 and 1.5 volppm. These phenomena began to appear 2 hours after fumigation was begun at 1.5 volppm and 3 hours after fumigation was begun at 1 volppm. However, the relation derived from Fig.

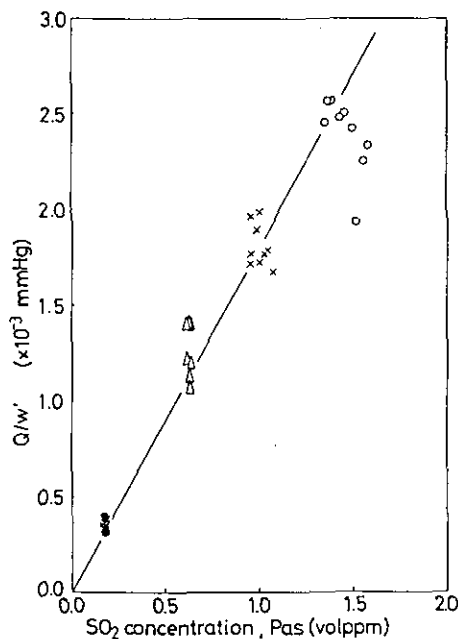

Fig. 4. Relation between  $SO_2$  concentration ( $P_{as}$ ) and the ratio of  $SO_2$  sorption rate divided by the water vapor pressure differences between gas-liquid interface in the leaf and the atmosphere ( $Q/w'$ ). Data were obtained from the results shown in Fig. 3.

3 reflects the influence of changes in  $\text{SO}_2$  concentration over a period of time while measurements were being taken and an increase in leaf temperature accompanying a decrease in the rate of transpiration. To eliminate these influences the relation was adjusted to that between  $Q/w'$  and  $P_{as}$ . Fig. 4 shows the results of this. Here  $w'$  is calculated as

$$w' = W / \{X_s(T_l) - \varphi X_s(T_a)\} \quad (6)$$

However, the leaf temperature is required in order to calculate  $w'$ . The only value obtained for leaf temperature was that determined before fumigation began. A value pertinent to an extended time period was sought by using the regression coefficient  $-5.8 \times 10^5 \text{ cm}^2 \cdot \text{s} \cdot ^\circ\text{C} \cdot \text{g}^{-1}$  obtained for  $\Delta T$  and  $W$  in Experiment I to estimate changes in leaf temperature from changes in the rate of transpiration  $\Delta W$  and by adding to these the prefumigation value. According to Eq. (5), a change in air temperature will influence the regression coefficient, but this influence is slight with change of up to  $10^\circ\text{C}$ . While it is difficult to obtain a reliable estimate of leaf temperature with this method, it should be possible to arrive at an approximate value for the average leaf temperature in order to calculate  $w'$ . According to Fig. 4, water-soaked on the leaf or wilting of leaves notwithstanding, it is apparent that a relation approximating  $Q/w' \simeq 1.8 \times 10^{-3} P_{as}$  may be obtained between  $Q/w'$  and  $P_{as}$ . It may be concluded from this result that aside from the special case of water-soaked on the surface, the main route of  $\text{SO}_2$  sorption in the sunflower is absorption through the stomata. Further, it should be possible to treat the mechanism of  $\text{SO}_2$  sorption in the same way as the mechanism of transpiration of the leaf (4, 8).

Next, plant surface boundary conditions in regard to  $\text{SO}_2$  were investigated by means of a simple model dealing with rates of transpiration and  $\text{SO}_2$  sorption on the leaf. When stomata are present on both surfaces of the leaf, the rates of transpiration and  $\text{SO}_2$  sorption on the leaf may be approximated respectively with the following equations.

$$W = 2 \{X_s(T_l) - \varphi X_s(T_a)\} / k_w (r_{wa} + r_{ws}) \quad (7)$$

$$Q = 2(P_{as} - P_{ls}) / k_s (r_{sa} + r_{ss} + r_b) \quad (8)$$

When  $Q/w'$  is calculated from Eqs. (6), (7) and (8), the following equation is obtained:

$$Q/w' = \{k_w (r_{wa} + r_{ws}) / k_s (r_{sa} + r_{ss} + r_b)\} (P_{as} - P_{ls}) \quad (9)$$

In Eq. (9) surface resistance  $r_b$  to  $\text{SO}_2$  is approximated as  $r_b \simeq 0 \text{ s} \cdot \text{cm}^{-1}$ , since absorption of  $\text{SO}_2$  on the leaf may be thought of as precipitate reaction absorption. Moreover, since the fact that the highest wind velocity within the test chamber was  $0.4 \text{ m} \cdot \text{s}^{-1}$  ( $Re \simeq 5 \times 10^3$ ), local or average boundary layer resistance  $r_a$  on the leaf may be approximated respectively with the following equations (5, 12):

$$r_a = 1 / (\alpha \cdot 0.332 Sc^{1/3} Re_x^{1/2} D/x) \quad (\text{local}) \quad (10)$$

$$r_a = 1 / (\alpha \cdot 0.664 Sc^{1/3} Re_l^{1/2} D/l) \quad (\text{average}) \quad (11)$$

Further, the following relation will exist in  $r_{sa}/r_{wa}$ ,  $r_{ss}/r_{ws}$  (8)

$$r_{sa}/r_{wa} = (D_s/D_w)^{-2/3} = 1.53 \quad (12)$$

$$r_{ss}/r_{ws} = (D_s/D_w)^{-1} = 1.89 \quad (13)$$

It is difficult to base calculations of boundary layer resistance on data from actual measurements when the number of leaves is great. However, if we postulate that  $r_{sa}/r_{wa} = r_{ss}/r_{ws} = k_r$ , there is no further necessity to calculate boundary layer resistance, and Eq. (9) is simplified.

$$Q/w' = (k_w/k_s k_r) (P_{as} - P_{ls}) \quad (14)$$

When the  $k_w/k_s k_r$  in Eq. (14) is calculated on the basis of  $k_r = 1.53$  and  $k_r = 1.89$ , it becomes  $1.8 \times 10^{-3} \text{ mmHg.volppm}^{-1}$  ( $k_r = 1.53$ ) and  $1.4 \times 10^{-3} \text{ mmHg.volppm}^{-1}$  ( $k_r = 1.89$ ). These values are virtually identical with the regression coefficient  $1.8 \times 10^{-3} \text{ mmHg.volppm}^{-1}$  obtained in Fig. 4. When  $k_r = 1.53$ ,  $P_{ls} = 0 \text{ volppm}$  are substituted in Eq. (14),  $Q/w' \approx 1.8 \times 10^{-3} P_{as}$  is obtained.  $k_w/k_s k_r$  appears to be somewhat variable due to air temperature and humidity conditions during the experiment.

Fig. 5 shows the comparative effects of air temperature and humidity conditions of  $32^\circ\text{C}$ , 50%RH and  $35.5^\circ\text{C}$ , 65%RH on  $Q/w'$ . There was a tendency for  $Q/w'$  to be less at  $32^\circ\text{C}$ , 50%RH than at  $35.5^\circ\text{C}$ , 65%RH. This may be attributed to i) change in  $Q/w'$  itself, ii) error in measurement or approximation of the  $\text{SO}_2$  sorption rate, air temperature, humidity and leaf temperature or, iii) the precision of the approximate models in Eqs. (5) and (6). These problems await further detailed study. The results obtained here are based on approximately five hours of experimental fumigation with  $\text{SO}_2$ . No mention has been made of  $\text{SO}_2$  sorption during longterm (several weeks or several months) fumigation. This question is extremely important when estimating amounts of  $\text{SO}_2$  sorption in the field, and it requires further detailed study. When we make inferences from the data at hand, however, it appears that the present results would be applicable for the period before visible leaf injury becomes marked.

*Abstraction of information regarding stomatal aperture and  $\text{SO}_2$  sorption rate through measurement of leaf temperature*

The relation between leaf temperature and stomatal resistance to water vapor may be obtained by substituting Eq. (7) in Eq. (5).

$$\Delta T = -L \{ X_s(T_l) - \varphi X_s(T_a) \} / \{ k_w(4\sigma T_a^3 + h_T) (r_{wa} + r_{ws}) \} + \alpha_p E_s / (8\sigma T_a^3 + 2h_T) \quad (15)$$

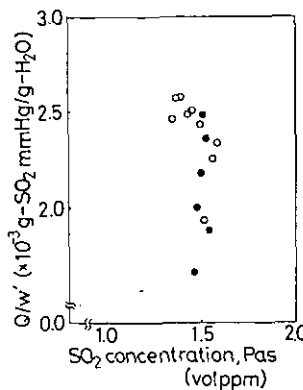

Fig. 5. Influences of air temperature and humidity on  $Q/w'$ . ○ denotes data at an air temperature of  $35.5^\circ\text{C}$  and a relative humidity of 65%. ● those at an air temperature of  $32^\circ\text{C}$  and a relative humidity of 50%.

If we assume that lighting conditions, air temperature, humidity and wind velocity within the test chamber were kept constant, it is possible to estimate stomatal resistance to water vapor by measuring  $\Delta T$ . Furthermore, stomatal resistance to water vapor and stomatal resistance to  $\text{SO}_2$  are mutually transformable by Eq. (13). In addition, the local  $\text{SO}_2$  sorption rate may be estimated from  $\Delta T$  by using the previously obtained relation between the mechanism of transpiration and that of  $\text{SO}_2$  sorption. This method may be considered acceptable for practical use but it does present difficulties from a strictly theoretical viewpoint of mass transfer.

*The role of the stomata in visible leaf injury appeared locally on the leaf*

Visible leaf injury in plants fumigated with atmospheric pollutants will vary on different leaf positions or sites on the leaf. However, there has been no analysis whatever of the causes of this phenomenon. This is due to the fact there has been no evaluation of visible leaf injury up to the present time based on information about the leaf that is accurate down to the local level, nor has there been any quantification of the factors presumed to contribute to visible leaf injury. Therefore we qualitatively investigated, in relation to quantities of the local  $\text{SO}_2$  sorption, the causes of visible injury appearing locally on leaves variously disposed on plants subsequent to fumigation with  $\text{SO}_2$  in a concentration of 1–2 volppm (Experiment III). The estimated quantity of local sorption

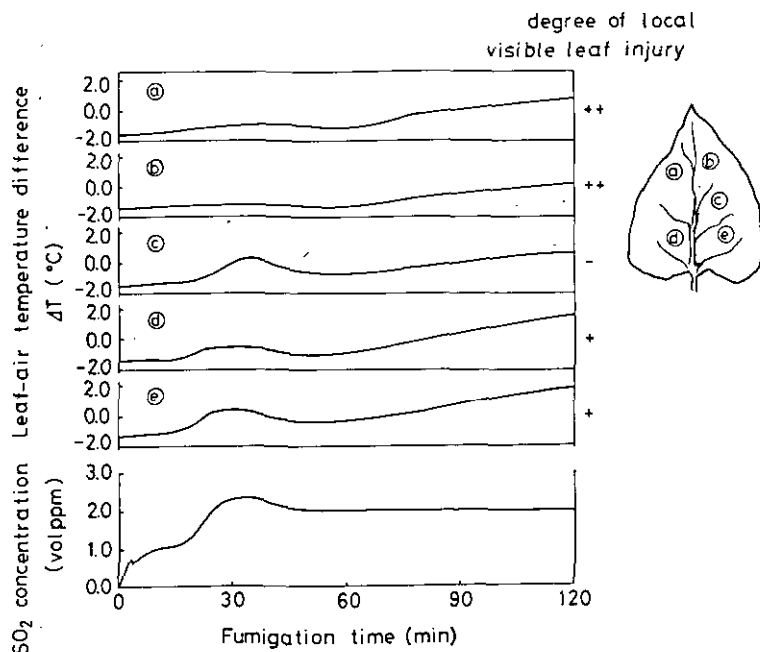

Fig. 6. Time courses of leaf-air temperature difference ( $\Delta T$ ) during  $\text{SO}_2$  fumigation and the degree of local visible leaf injury ( $-$ ,  $+$ ,  $++$ ) after fumigation under an air temperature of  $26^{\circ}\text{C}$ , a relative humidity of 60% and a light intensity of 40klux. The degree of local visible leaf injury was estimated by measuring the ratio of injured leaf area in a circular area (10 mm in diameter) where a thermo-couple was set.  $-$  denotes the ratio of injured leaf area being 0,  $+$  the ratio being less than 1/2,  $++$  the ratio being greater than 1/2.

was based on leaf temperature measurements, using the relation mentioned above. Leaf temperature was measured with a thermocouple. Since this method involves measurement by direct contact it is not necessarily a desirable one for obtaining accurate local information. However, there has not been any essential omission in the results obtained.

Fig. 6 shows representative examples of leaf-air temperature difference at different sites on a leaf under fumigation with approximately 2 volppm of  $\text{SO}_2$  over a 2 hour period. Despite the fact that the leaf-air temperature differences at all sites were relatively uniform at  $-1.3$  to  $-1.7^\circ\text{C}$  prior to fumigation, uniformity was lost as fumigation went on. Visible leaf injury progresses with water-soaked on the leaf surface, wilting of leaves, fading of pigment, necrosis and chlorosis. However, in this experiment, at the end of the 2 hour exposure to  $\text{SO}_2$  no signs of injury were visible. 20 hours later injury had progressed to the stage of necrosis and chlorosis, but no further. The sites with the greatest degree of visible leaf injury at this time were those that had exhibited the slowest increase in leaf temperature.

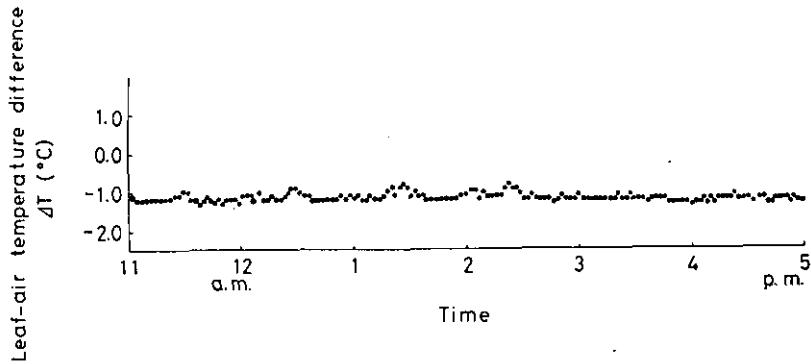

Fig. 7. Time course of leaf-air temperature difference ( $\Delta T$ ) with no  $\text{SO}_2$  fumigation. Air temperature,  $26^\circ\text{C}$ ; humidity, 60%RH; light intensity, 40klux.

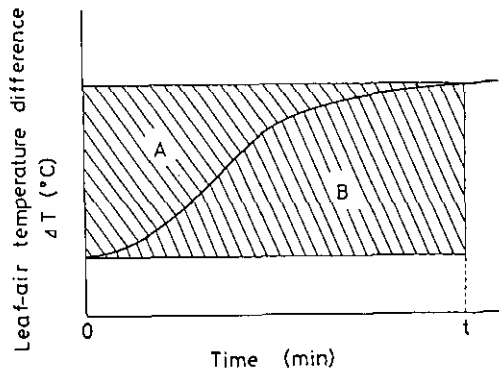

Fig. 8. Schematic representation of the response of leaf-air temperature difference ( $\Delta T$ ), during  $\text{SO}_2$  fumigation. The degree of response is indicated by the ratio of areas  $A/(A+B)$ .  $A/(A+B)$  becomes small for a fast response.



As Fig. 7 shows, the leaf-air temperature difference (value from measurement at one point) is constant when environmental conditions inside the test chamber are constant without  $\text{SO}_2$  fumigation. This suggests that the increase in leaf-air temperature difference at various sites of the leaf is due to stomatal closure under the influence of  $\text{SO}_2$ . We have quantified the degree of injury and increase in leaf temperature in order to discuss the relation between them in quantitative terms. The degree of injury has been expressed as it was in Experiment III.

Quantification of change occurring over a period of time in leaf temperature agrees with the model shown in Fig. 8. In the figure, the total area encompassing the curved line is designated (A+B), this area is subdivided into A and B by the same curved line which represents the leaf-air temperature difference. A smaller ratio of  $A/(A+B)$  signifies a more rapid increase in leaf temperature under  $\text{SO}_2$  fumigation.

Fig. 9 shows the relation between the degree of visible leaf injury and  $A/(A+B)$  on leaves taken from different locations on a plant. A close relation could be discerned, for each leaf between the rate of leaf temperature increase and the degree of visible injury. We concluded from the interrelation obtained between transpiration rate, change in leaf temperature and  $\text{SO}_2$  sorption rate that the rate of stomatal closure is slower at sites with a slow increase in leaf temperature. Consequently comparatively greater amounts of  $\text{SO}_2$  are sorbed at sites where leaf temperature increases slowly. Furthermore, this interrelation indicates that change in stomatal resistance at various sites on the leaf is an important factor in visible leaf injury.

The above conclusions, reached with the aid of an artificial environment, suggest that apparently complex phenomena observed under actual field conditions may be explained by indexes of amounts of sorption. It is to be hoped that hereafter these various phenomena relating to mechanisms of sorption will be elucidated as a prerequisite to studies of various biological factors at the individual level.

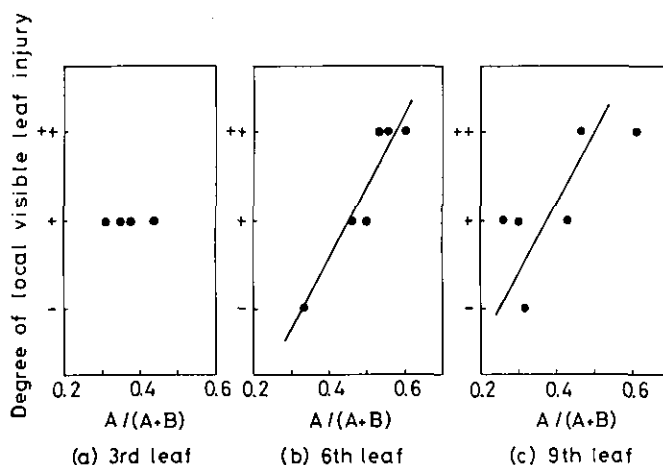

Fig. 9. Relation between  $A/(A+B)$  ratio, an index of the response of leaf-air temperature difference, and degree of local visible leaf injury (-, +, ++).

We sincerely wish to thank Dr. I. Aiga, group manager of the Division of Engineering of our Institute, Dr. T. Totsuka, group manager of the Division of Environmental Biology, and Drs. A. Furukawa and N. Kondo for their valuable advice, and members of the Division of Engineering who took part in maintenance of the equipment and cultivation of plants used in the experiment.

This report is a reconstructed version of a paper (11) published in *Journal of Agricultural Meteorology*.

#### References

1. Bennet, J. H., A. C. Hill and D. M. Gates: A model for gaseous pollutant sorption by leaves. *J. Air Poll. Control Ass.* 23: 957-962 (1973).
2. Fowler, D. and M. H. Unsworth: Dry deposition of sulphur dioxide on wheat. *Nature* 249: 389-390 (1974).
3. Gates, D. M. and L. V. E. Papias: *Atlas of energy budgets of plant leaves*. p.3-16. Academic Press, New York, 1971.
4. Haseba, T.: Agro-meteorological studies of transpiration in plant leaf in relation to the environment. *Mem. Coll. Agr., Ehime Univ.* 18: 1-141 (1973).
5. Haseba, T.: Water-vapor transfer from fluttering leaves within a plant canopy. Field observations and laboratory experiments. *J. Agr. Meteorol.* 31: 135-143 (1975).
6. Hill, A. C.: Vegetation: a sink for atmospheric pollutants. *J. Air Poll. Control Ass.* 21: 341-346 (1971).
7. Iwakiri, S.: Air pollution injury. In *Handbook for agricultural meteorology*. p.633-656. Yokendo, Tokyo, 1974.
8. Monteith, J. L.: *Principles of environmental physics*. p.134-189. Edward Arnold, London, 1973.
9. Mudd, J. B.: Sulfur dioxide. In *Responses of plants to air pollution*. Edited by J. B. Mudd and T. T. Kozlowski. p.11-13. Academic Press, New York, 1975.
10. Omasa, K. and I. Aiga: Control of air pollutant concentration in an environmental chamber for plant experiments (I). *Proc. ann. meeting, Refrigeration (Tokyo)*. 27-30 (1976).
11. Omasa, K. and F. Abo: Studies of air pollutant sorption by plants. (I) Relation between local SO<sub>2</sub> sorption and acute visible leaf injury. *J. Agr. Meteorol.* 34:51-58 (1978).
12. Parlange, J. Y., P. E. Waggoner and G. H. Heichel: Boundary layer resistance and temperature distribution on still and flapping leaves. *Plant Physiol.* 48:437-442 (1971).
13. Spedding, D. J.: Uptake of sulphur dioxide by barley leaves at low sulphur dioxide concentrations. *Nature* 224: 1229-1231 (1969).
14. Taniyama, T. and H. Arikado: Studies on the mechanism of injurious effects of toxic gases on crop plants. I. Relation between the concentration of sulfur dioxide and the degree of leaf injuries in several crops. *Jap. J. Crop Sci.* 37: 366-371 (1968).
15. Thomas, M. D. and G. R. Hill Jr.: Absorption of sulphur dioxide by alfalfa and its relation to leaf injury. *Plant Physiol.* 10: 291-307 (1935).
16. Unsworth, M. H., P. V. Biscoe and V. Black: Analysis of gas exchange between plants and polluted atmospheres. In *Effects of air pollutants on plants*. Edited by T. A. Mansfield. p.5-16. Cambridge University Press, London, 1976.

## Analysis of air pollutant sorption by plants

### (2) A method for simultaneous measurement of NO<sub>2</sub> and O<sub>3</sub> sorptions by plants in environmental control chamber

Kenji Omasa<sup>1</sup>, Fumiaki Abo<sup>1</sup>, Shu Funada<sup>2</sup> and Ichiro Aiga<sup>1</sup>

<sup>1</sup> Division of Engineering, The National Institute for Environmental Studies, Yatabe, Ibaraki 305

<sup>2</sup> Faculty of Agriculture, Ehime University, Matsuyama 790

A method for simultaneous measurement of NO<sub>2</sub> and O<sub>3</sub> sorption rates of plants in an environmental control chamber was examined. Namely, NO<sub>2</sub> and O<sub>3</sub> reactions in the chamber were identified and an equation for calculation of the sorption rates, which took the reactions of gases into consideration, was examined. The results obtained were as follows.

(1) NO<sub>2</sub> reaction rate  $R^{\text{NO}_2}$  and O<sub>3</sub> reaction rate  $R^{\text{O}_3}$  in the chamber were given by

$$R^{\text{NO}_2} = k^{\text{NO}_2} \cdot C_d^{\text{NO}_2} \cdot C_d^{\text{O}_3},$$

and

$$R^{\text{O}_3} = k^{\text{O}_3} \cdot C_d^{\text{NO}_2} \cdot C_d^{\text{O}_3},$$

where  $k^{\text{NO}_2}$  is the rate constant of the NO<sub>2</sub> reaction,  $k^{\text{O}_3}$  is the rate constant of the O<sub>3</sub> reaction,  $C_d^{\text{NO}_2}$  is the NO<sub>2</sub> concentration and  $C_d^{\text{O}_3}$  is the O<sub>3</sub> concentration. The value of  $k^{\text{NO}_2}$  was about 17.5 m<sup>6</sup> · g<sup>-1</sup> · s<sup>-1</sup> and  $k^{\text{O}_3}$  was about 9.5 m<sup>6</sup> · g<sup>-1</sup> · s<sup>-1</sup>, and these values were slightly influenced by the air conditioning system. The results were nearly equal to the rate constants of the reactions of NO<sub>2</sub> + O<sub>3</sub> → NO<sub>3</sub> + O<sub>2</sub> and NO<sub>3</sub> + NO<sub>2</sub> + H<sub>2</sub>O → 2HNO<sub>3</sub>.

(2) An equation for the calculation of gas sorption rates in NO<sub>2</sub> + O<sub>3</sub> was given by

$$\hat{P}_h = A \cdot x_h + B \cdot x_h + C \cdot z_h,$$

where,

$$\hat{P}_h = \begin{bmatrix} \Delta \hat{P}_h^{\text{NO}_2} \\ \Delta \hat{P}_h^{\text{O}_3} \end{bmatrix}, \quad x_h = \begin{bmatrix} \Delta \hat{C}_{dh}^{\text{NO}_2} \\ \Delta \hat{C}_{dh}^{\text{O}_3} \end{bmatrix}, \quad z_h = \begin{bmatrix} \Delta \hat{C}_{dh}^{\text{NO}_2} - \Delta \hat{C}_{dh-1}^{\text{NO}_2} \\ \Delta \hat{C}_{dh}^{\text{O}_3} - \Delta \hat{C}_{dh-1}^{\text{O}_3} \end{bmatrix},$$

$$A = \begin{bmatrix} -F & 0 \\ 0 & -F \end{bmatrix}, \quad B = \begin{bmatrix} -k^{\text{NO}_2} \cdot C_d^{\text{O}_3} & -k^{\text{NO}_2} \cdot C_d^{\text{NO}_2} \\ -k^{\text{O}_3} \cdot C_d^{\text{O}_3} & -k^{\text{O}_3} \cdot C_d^{\text{NO}_2} \end{bmatrix}_S, \quad C = \begin{bmatrix} -V/\tau & 0 \\ 0 & -V/\tau \end{bmatrix},$$

and

$$\Delta \hat{C}_{dh} = \left\{ (2T_c - \tau) / (2T_c + \tau) \right\} \Delta \hat{C}_{dh-1} + \left\{ \tau / (2T_c + \tau) \right\} (\Delta C_{dh} + \Delta C_{dh-1}),$$

and where  $\Delta \hat{P}_h^{\text{NO}_2}$  is the  $\text{NO}_2$  sorption rate,  $\Delta \hat{P}_h^{\text{O}_3}$  is the  $\text{O}_3$  sorption rate,  $F$  is the ventilation flow rate,  $V$  is the volume in the chamber,  $\tau$  is a sampling time,  $\Delta C_d^{\text{NO}_2}$  is the change in  $\text{NO}_2$  concentration from the initial condition and  $\Delta C_d^{\text{O}_3}$  is the change in  $\text{O}_3$  concentration. The suffix  $h$  denotes the values at time  $h \cdot \tau$  and  $S$  denotes the values in the steady-state before plants are placed in the chamber. The reaction term  $B \cdot x_h$  and the differential term  $C \cdot z_h$  in the equation are correction terms to obtain the exact sorption rates. The  $B \cdot x_h$  term corrects the static characteristics, and the  $C \cdot z_h$  term corrects the dynamic characteristics. As an example, the effect of  $B \cdot x_h$  on static characteristics was examined. If  $B \cdot x_h$  was not considered, errors in the measurements of the sorption rates would be 20% of  $\Delta U_{max}^{\text{NO}_2}$  and 30% of  $\Delta U_{max}^{\text{O}_3}$ , where  $\Delta U_{max}^{\text{NO}_2}$  and  $\Delta U_{max}^{\text{O}_3}$  are given in Fig. 3. By considering  $B \cdot x_h$ , the errors were reduced to 5%. Effects of the  $C \cdot z_h$  term on dynamic characteristics were also examined. The effect of the  $C \cdot z_h$  depended upon the time constant  $T_c$  of the digital filter and noise of the process and the gas analyzer. In the steady-state, the errors were increased by  $C \cdot z_h$ . However, increase of  $T_c$  tended to reduce the noise, because the noise was smoothed by the filter. In transient conditions, the error was increased by the noise, like steady-state with small  $T_c$  and also by the lag time of the filter in the case of large  $T_c$ . By choosing an optimal  $T_c$ , however, the error was reduced to within 10% ( $IAE/\Delta U_{max}$ ) to changes in  $\Delta P/T_{tt} \cdot C_{d_s} = 0.9 \times 10^{-8} \text{ g}^{-2} \cdot \text{s} \cdot \text{volppm}^{-1}$ , where  $T_{tt}$  was given in Fig. 3. In the system, the optimum value of  $T_c$  was found to be 1~2 min.

(3) Rates of transpiration,  $\text{NO}_2$  sorption and  $\text{O}_3$  sorption were measured simultaneously. The fastest change of gas sorption rate of plants was approximately  $1.5 \times 10^{-9} \text{ g} \cdot \text{s}^{-2} \cdot \text{volppm}^{-1}$ . Therefore, the method of measurement and the system described here may have satisfactory dynamic characteristics.

**Key words:**  $\text{NO}_2 + \text{O}_3$  - Plant sorptions - Simultaneous measurement.

An atmospheric air in urban and industrialized areas contains a variety of pollutants such as sulfur oxides, nitrogen oxides and photochemical oxidants (9). There has been a number of studies published in recent years on the effects of mixed air pollutants on vegetation. Such studies are still smaller in number than those on the effects of a single air pollutant on vegetation (12, 16, 19, 20). Clarification of the mechanism of sorption of mixed air pollutants by plants is a prerequisite for studies on the effects of mixed air pollutants on plants as well as for studies on models for forecasting the air-cleansing functions of plants (13, 14, 18).

Studies on method of measuring the sorption of air pollutants by plants exposed to single gas have been reported by Hill (7, 8) and Rogers et al. (17). However, many of the air pollutants are highly reactive and the extent of reactivity varies from one pollutant to another. Moreover, when plants are exposed to various air pollutants, the accuracy of measurements are significantly influenced by reactions among different gases and their reactions with the heat exchanger and the wall surfaces inside the chamber. However, no report has been made on a sorption measuring method which takes into account the effects of these reactions.

In order to measure the rates of sorption of gaseous pollutants by plants exposed to mixed gases, it is imperative (1) that the reactions among the gases in the chamber, the reactions of the gases with the heat exchanger and the wall surfaces, and any other phenomena with bearing upon the accuracy of measurements be accurately grasped, and the measurement errors be fully examined; (2) that the rate of sorption of each type of gas and the rate of transpiration can be measured simultaneously; and (3) that the system

of measurement be able to trace the sorption behaviors of plants. With the use of the environmental control chamber installed at the National Institute for Environmental Studies (1), we exposed plants to a gas mixture of  $\text{NO}_2 + \text{O}_3$  to examine a method for sorption rate measurement which satisfies the conditions listed above.

### Outline of the measuring method

The flow of air pollutants inside the environmental control chamber for measurement of the rates of gas sorption by plants is schematically shown in Fig. 1. Assuming that the dynamic characteristics of the air in the chamber are those of a model of perfect mixture (4, 6, 11), the gaseous exchange is expressed by

$$d(V \cdot C_d) / dt = F_i \cdot C_i - F_d \cdot C_d - P - R - D + U \quad (1)$$

where  $V$  is chamber inner volume ( $13 \text{ m}^3$ ),  $F_i$  is flow rate of fresh air ( $\text{m}^3 \cdot \text{s}^{-1}$ ),  $F_d$  is flow rate of exhaust air ( $\text{m}^3 \cdot \text{s}^{-1}$ ),  $C_i$  is gas concentration of fresh air ( $\text{g} \cdot \text{m}^{-3}$ , volppm),  $C_d$  is gas concentration in the chamber ( $\text{g} \cdot \text{m}^{-3}$ , volppm),  $P$  is gas sorption rate of plants ( $\text{g} \cdot \text{s}^{-1}$ ,  $\text{m}^3 \cdot \text{volppm} \cdot \text{s}^{-1}$ ),  $R$  is reaction rate ( $\text{g} \cdot \text{s}^{-1}$ ,  $\text{m}^3 \cdot \text{volppm} \cdot \text{s}^{-1}$ ),  $D$  is disturbance ( $\text{g} \cdot \text{s}^{-1}$ ,  $\text{m}^3 \cdot \text{volppm} \cdot \text{s}^{-1}$ ),  $U$  is manipulated variable, i.e., gas addition rate ( $\text{g} \cdot \text{s}^{-1}$ ,  $\text{m}^3 \cdot \text{volppm} \cdot \text{s}^{-1}$ ), and  $t$  is time (s). Reactions of air pollutants in the chamber are varied. For instance, air pollutants react with each other; they are absorbed by the heat exchanger; and they are adsorbed by the wall surfaces. Due to the complexity of the reaction system, it is generally difficult to represent gaseous reactions in the form of an accurate and detailed reaction model. For the sake of simplicity, therefore, that portion of the reactions which depends on gas concentration and is representable is expressed by the reaction term  $R$  and the rest is expressed by the disturbance term  $D$ .  $R$  is obtained by experiments, and when the reactions of  $N$  different gaseous ingredients ( $C_d^1, C_d^2, \dots, C_d^N$ ) are involved it is generally expressed by the following equation.

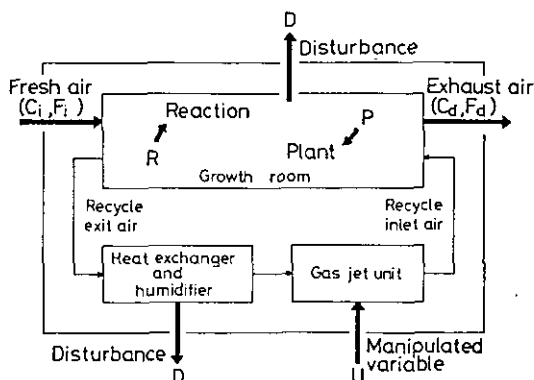

Fig. 1. Schematic diagram of the material balance of air pollutants in an environmental control chamber.

- $C_i$  : gas concentration of fresh air
- $C_d$  : gas concentration of room and exhaust air
- $F_i$  : air flow rate of fresh air
- $F_d$  : air flow rate of exhaust air
- $R$  : reaction rate which depends on gas concentration
- $P$  : gas sorption rate of plants
- $U$  : manipulated variable
- $D$  : disturbance

$$R \equiv R(C_d^1, C_d^2, \dots, C_d^N) \quad (2)$$

By way of a Taylor's expansion of Eq. (1) around situation  $S$ , with Eq. (2) taken into consideration, by linearizing the expanded equation through elimination of the 2 and higher order terms, and by expressing the deviation of each variable by  $\Delta C_i$ ,  $\Delta C_d^i$ ,  $\Delta P$ ,  $\Delta D$ ,  $\Delta U$ , the following equation is obtained.

$$V \cdot d\Delta C_d/dt = F \cdot \Delta C_i - F \cdot \Delta C_d - \Delta P - \sum_i [\partial R / \partial C_d^i]_S \cdot \Delta C_d^i - \Delta D + \Delta U \quad (3)$$

where the suffix  $S$  denotes values in situation  $S$ , and  $\Delta C_i$ ,  $\Delta C_d$ ,  $\Delta P$ ,  $\Delta D$  and  $\Delta U$  denote the values with respect to that gaseous ingredient out of the  $N$  ingredients which is being measured at present. Furthermore, it is assumed that  $F_i = F_d = F$  and that  $F$  and  $V$  are constant.

There are alternative methods for using Eq. (3) to calculate the rate of gas sorption by plants. One is to calculate the sorption rate on the basis of the change in gas concentration  $\Delta C_d^i$  in the chamber. The other is to calculate on the basis of the change in gas addition rate  $\Delta U$ . This paper explains a procedure based on the former method. The calculation is carried out in the following way: first, the gas to be experimented with is supplied into the chamber at a certain flow rate; when the gas concentration in the chamber has become steady, the plants are placed in the chamber; and the rate of gas sorption is calculated on the basis of the subsequent change in gas concentration. Since the gas addition rate is controlled to be constant,  $\Delta U = 0$ . Moreover, if the air pollutants contained in fresh air inlet are removed by the filter, then  $\Delta C_i = 0$ . Now, if it is assumed that situation  $S$  is that of steady-state before placing the plants in the chamber, then  $\Delta P$ ,  $\Delta C_d^i$  and  $\Delta D$  represents deviations from the steady-state values. The change in gas sorption rate,  $\Delta P$ , is derived from Eq. (3) and represented as follows.

$$\Delta P = -F \cdot \Delta C_d - \sum_i [\partial R / \partial C_d^i]_S \cdot \Delta C_d^i - V \cdot d\Delta C_d/dt - \Delta D \quad (4)$$

It should be noted that in situation  $S$ , namely in the steady-state before plants are placed in the chamber, the gas sorption rate  $P$  is zero, and therefore that the change in gas sorption rate  $\Delta P$  is identical with the gas sorption rate. Thus, hereinafter  $\Delta P$  shall be called gas sorption rate.

When actually measuring the gas sorption rate with the use of the chamber, it is necessary to examine through experiments beforehand the reaction term  $\sum_i [\partial R / \partial C_d^i]_S \cdot \Delta C_d^i$  and the disturbance term  $\Delta D$ . As for the reaction term, it is imperative to determine  $[\partial R / \partial C_d^i]_S$  beforehand so that it can be used in calculating the gas sorption rate. As for the disturbance term, it is imperative to look into the causes giving rise to disturbances and devise measures that warrant an assumption that  $\Delta D = 0$ . It is also important to devise measures for coping with the noise of the gas analyzer so as to measure  $\Delta C_d$  accurately. Aoki (2) has proposed a method for measuring the rate of photosynthesis using an average of concentration values measured at different periods. Smoothing of the values of gas concentration in this way or otherwise is effective in removing not only the analyzer noise but also the high frequency components of the air flow which cannot be represented by a model of perfect gas mixture. In this report we adopted a digital filter represented by the following equation which is well adapted for computer processing.

$$\Delta \hat{C}_{d_h} = \left\{ (2T_c - \tau) / (2T_c + \tau) \right\} \cdot \Delta \hat{C}_{d_{h-1}} + \left\{ \tau / (2T_c + \tau) \right\} \cdot (\Delta C_{d_h} + \Delta C_{d_{h-1}}) \quad (5)$$

This filter is a digital representation of a filter having time constant  $T_c$  in the analog system with a first order lag. In the equation,  $\tau$  denotes a sampling interval and the suffix  $h$  denotes the values at sampling time  $h$ . In view of these points, the required equation for calculation of gas sorption rate by plants is expressed as follows.

$$\Delta \hat{P}_h = -F \cdot \Delta \hat{C}_{d_h} - \sum_i [\partial R / \partial C_d^i]_s \cdot \Delta \hat{C}_{d_h}^i - V \cdot (\Delta \hat{C}_{d_h} - \Delta \hat{C}_{d_{h-1}}) / \tau \quad (6)$$

where the sampling interval  $\tau$  should be sufficiently small compared with the time lags of the process and the filter.

### Equipment and method of experiment

#### Environmental control chamber

The apparatus consists of a measurement chamber in which plants are exposed to air pollutants to measure the rates of their pollutant sorption (inner volume of the growth room: 2.3(W) × 1.7(D) × 1.9(H); m<sup>3</sup>), a fresh air processing and supplying device for supplying the measurement chamber with a stable flow of fresh pollutant-free air and a processing device for removing the pollutants from the exhaust air. The flow rate of processed fresh air supply to the measurement chamber (or the flow rate of air exchange),  $F$ , is controlled by an automatic damper with high accuracy. The measurement chamber is capable of controlling temperature, humidity and gas concentration in the chamber. The temperature and the humidity of the fresh air are also controlled. The velocity of recycling air flow is constant, i.e., at the level of 0.22 m·s<sup>-1</sup> (with standard deviation of 0.05 m·s<sup>-1</sup>) in the growth room.

#### DDC system for examination of the measurement method

A block diagram of a Direct Digital Control (DDC) system for examination of the measurement method is illustrated in Fig. 2. In this system, the computer, with which

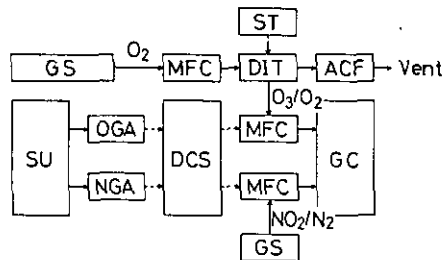

Fig. 2. Block diagram of DDC system.

- GS : gas storage
- ST : stabilized power supply
- DIT : discharge tube
- MFC : mass flow controller
- ACF : active carbon filter
- SU : gas sampling unit in growth room
- OGA : O<sub>3</sub> gas analyzer
- NGA : NO<sub>2</sub> gas analyzer
- DCS : digital computer system
- GC : gas jet unit in control chamber

both detectors and manipulated means are connected in an on-line mode, is capable of undertaking analysis by employing any algorithm that is suited for the purpose of an experiment. A mass flow controller controls, in accordance with manipulation signals relayed from the computer, the flow rate of gases of predetermined concentrations, and feed them into the measurement chamber.  $\text{NO}_2$  gas was supplied from a gas tank of predetermined concentration, whereas the  $\text{O}_3$  gas, which cannot be supplied from a gas tank, was generated from  $\text{O}_2$  with the use of an  $\text{O}_3$  generator by way of silent electric discharge, and was supplied by keeping its concentration as constant as possible. The gas analyzers for both  $\text{NO}_2$  and  $\text{O}_3$  are based on the chemiluminescent methods as their principle of measurement.

#### *Method of experiment*

The method of measurement based on the principle mentioned above for use in measuring the rates of gas sorption by plants exposed to a gas mixture of  $\text{NO}_2 + \text{O}_3$  was examined. The procedure actually followed in the experiment was as follows.

**Experiment I – Examination of the reaction term:** The property of the reaction term  $R$  was investigated by conducting an experiment with combinations of various concentrations of  $\text{NO}_2$  (1.0 – 8.0 volppm) and  $\text{O}_3$  (0.2 – 0.8 volppm). The flow rate of air exchange  $F$  was kept constant and the concentration of one of the two gases was maintained at a constant level, while the desired concentration value of the other gas was changes once every two hours in accordance with a programmed schedule. For each different concentration level of the gas, the steady-state value  $U$  of the flow rate of its inlet was obtained; and with the use of  $U$ , the reaction term was calculated from the following equation.

$$R = U - F \cdot C_d \quad (7)$$

In carrying out the above experiment, temperature and humidity of the air inside the chamber, temperature of the coil surface, temperature and humidity of fresh air were maintained constant levels so as to reduce the effects of the air conditioning system on measurements.

**Experiment II – Examination of the effects of the air conditioning system on gas concentration:** The qualitative characteristics of the effects of the air conditioning system on gas concentration in case of gas mixture of  $\text{NO}_2 + \text{O}_3$  were examined. After  $\text{NO}_2$  and  $\text{O}_3$  were supplied to the measurement chamber at constant flow rates, and after their concentrations inside the chamber were constant, temperature and humidity of the air inside the chamber and temperature of the heat exchanger's coil surface were varied. The resulting changes in gas concentration were measured over a span of time.

**Experiment III – Examination of the precision of measurement (I):** The effects of the reaction term in the present method for measuring the rates of sorption by plants exposed to gas mixture of  $\text{NO}_2 + \text{O}_3$  were investigated. After  $\text{NO}_2$  and  $\text{O}_3$  were supplied to the measurement chamber at constant flow rates, and after their concentrations inside the chamber were constant,  $\text{NO}_2$  and  $\text{O}_3$  were manipulated stepwise at a rate almost equivalent to the rate of gas sorption,  $\Delta P$ , by 10 sunflower plants. On the basis of the changes in gas concentrations, comparison was made between the measurement error when the reaction term was taken into consideration and when the term was not taken into consideration. In this experiment, the differential term in the equation was neglected. With the assumption that the change in gas introduced  $-\Delta U$  represents the net sorption rate  $\Delta P$ , then the measurement error  $P - \hat{P}$  was given by  $-\Delta U - \hat{P}$ . Here,



$\hat{P}$  can be derived from Eq. (6) or Eq. (11).

Experiment IV – Examination of the precision of measurement (II): The effects of the digital filter and the differential term in the present method for measuring the rates of sorption by plants exposed to gas mixture of  $\text{NO}_2 + \text{O}_3$  were investigated. The procedure of the experiment and the method for assessment of the reliability of measurements are schematically illustrated in Fig. 3.  $\text{NO}_2$  was supplied into the chamber at a constant flow rate, with  $\text{O}_3$  concentration controlled at a fixed level; after  $\text{NO}_2$  concentration was constant, the  $\text{NO}_2$  flow rate was changed in a step or lamp mode as shown in Fig. 3. From the resulting changes in gas concentration,  $\Delta\hat{P}^{\text{NO}_2}$  was calculated, and the accuracy of the calculated value  $\Delta\hat{P}^{\text{NO}_2}$  was evaluated with the use of IAE. IAE – i.e., an average with respect to time of the integral of the absolute error between the net gas sorption rate and the calculated gas sorption rate – which is defined by the following equation,

$$\begin{aligned} \text{IAE} &= \sum^n |\Delta\hat{P}^{\text{NO}_2} + \Delta U^{\text{NO}_2}| \cdot \tau / T \\ &= \sum^n |\Delta\hat{P}^{\text{NO}_2} - \Delta P^{\text{NO}_2}| \cdot \tau / T \end{aligned} \quad (8)$$

where time span  $T_s$  in Fig. 3 was used for  $T$  in assessing how accurately the static characteristics were corrected, and  $T_r$  in assessing how accurately the dynamic characteristics were corrected. The integer number  $n$  is obtained from  $n = T/\tau$ . The sampling interval  $\tau$  was chosen to be small enough compared with both the time span  $T$  and the time constant  $T_c$  of the digital filter, i.e.,  $\tau = 2$  sec.

Experiment V – Continuous and simultaneous measurement of the rate of transpiration and the rates of  $\text{NO}_2$  and  $\text{O}_3$  sorption by plants: By exposing plants to the gas mixture, the rates of their transpiration and  $\text{NO}_2$  and  $\text{O}_3$  sorption were measured continuously and simultaneously. The  $\text{NO}_2$  and  $\text{O}_3$  sorption rates were measured by the method explained above, while the transpiration rate was measured with the use of an electronic balance scale accurate to 0.1 g. As the materials for the experiment, 10 sunflower plants (*Helianthus annuus* L. cv. Russian Mammoth) which had been grown for 6 weeks after planting (and had grown to have a total leaf surface area of  $2.06 \times 10^4 \text{ cm}^2$ ) were used.

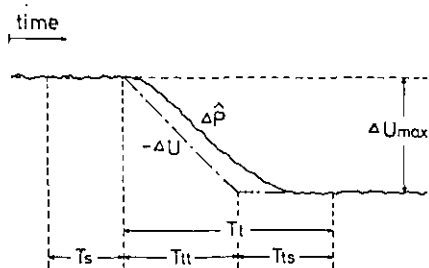

Fig. 3. Schematic representation for the evaluation of measurement error.  $\Delta U$  denotes changes of manipulated variable, and  $-\Delta U$  is net sorption rate ( $\Delta P$ ).  $\Delta\hat{P}$  denotes sorption rate calculated from Eq. (6), (cf. Eq. (11)). In the experiments,  $\Delta U$  is manipulated as a step or lamp mode, and reliability of  $\Delta\hat{P}$  is evaluated by IAE (Eq. (8)).

**Gas reactions in the measurement chamber**

*Reaction under exposure to gas mixture of NO<sub>2</sub> + O<sub>3</sub>*

A large number of reports have been made on reactions of air pollutants in the atmospheric air (5, 10). A system of reactions taking place inside an environmental control chamber is considered to be complex, as it involves not only gas reactions in the atmospheric air, but also reactions of the air pollutants with a heat exchanger, a humidity controller, wall surfaces, etc.. Consequently, there are many points to be clarified about gas reactions in a chamber. To determine the reaction term in the equation for calculation of sorption rates by plants, an inquiry was made into reactions taking place in the chamber during fumigation with a gas mixture of NO<sub>2</sub> + O<sub>3</sub>.

The reaction rates of NO<sub>2</sub> and O<sub>3</sub> at different concentration levels are shown in Fig. 4 (Experiment I). In the figure, (a) and (b) were obtained from experiments in which NO<sub>2</sub> concentration was changed in accordance with a programmed schedule, with O<sub>3</sub> concentration kept constant; while (c) and (d) were obtained by changing O<sub>3</sub> concentration, with NO<sub>2</sub> concentration kept constant. It was observed that both NO<sub>2</sub> reaction rate  $R^{NO_2}$  and O<sub>3</sub> reaction rate  $R^{O_3}$  for each concentration level varied linearly with gas con-

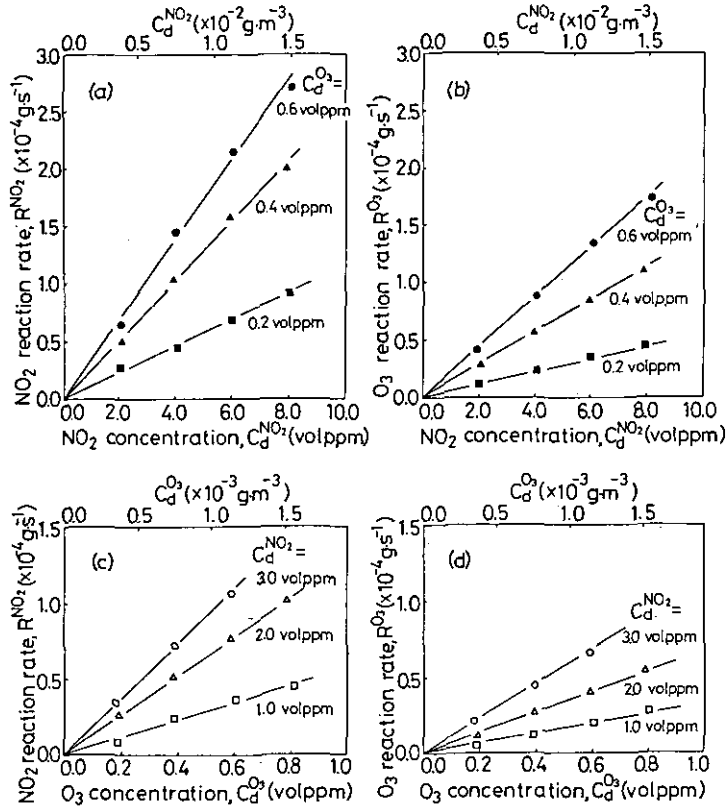

Fig. 4. NO<sub>2</sub> reaction rate ( $R^{NO_2}$ ) and O<sub>3</sub> reaction rate ( $R^{O_3}$ ) in the chamber. (a) and (b) were obtained from experiments in which NO<sub>2</sub> concentration was varied and O<sub>3</sub> concentration was maintained constant. (c) and (d) were obtained from experiments in which O<sub>3</sub> concentration was varied and NO<sub>2</sub> concentration was maintained constant.

centration, irrespective of the type of gas being changed. This suggests that the following two relations exist between reaction rate  $R^{\text{NO}_2}$  or  $R^{\text{O}_3}$  on the one hand and  $\text{NO}_2$  concentration  $C_d^{\text{NO}_2}$  and  $\text{O}_3$  concentration  $C_d^{\text{O}_3}$  on the other.

$$R^{\text{NO}_2} = k^{\text{NO}_2} \cdot C_d^{\text{NO}_2} \cdot C_d^{\text{O}_3} \quad (9)$$

$$R^{\text{O}_3} = k^{\text{O}_3} \cdot C_d^{\text{NO}_2} \cdot C_d^{\text{O}_3} \quad (10)$$

In order to test these relations, the results in Fig. 4 were reorganized into a relation between  $R/C_d^{\text{NO}_2}$  and  $C_d^{\text{O}_3}$  as shown in Fig. 5. From the results given in Fig. 5, it was confirmed that the relations represented by Eqs. (9) and (10) actually hold true. The regression coefficients in Fig. 5, the rate constants of reaction  $k^{\text{NO}_2}$  and  $k^{\text{O}_3}$  in Eqs. (9) and (10), were found to be  $k^{\text{NO}_2} = 17.5 \text{ m}^6 \cdot \text{g}^{-1} \cdot \text{s}^{-1}$  and  $k^{\text{O}_3} = 9.5 \text{ m}^6 \cdot \text{g}^{-1} \cdot \text{s}^{-1}$ , i.e.,  $k^{\text{NO}_2} \approx 2k^{\text{O}_3}$ . By dividing these constants by the chamber's inner volume  $V$ , rate constants of reaction per unit volume of the chamber,  $k'^{\text{NO}_2}$  and  $k'^{\text{O}_3}$ , were obtained, i.e.,  $k'^{\text{NO}_2} = 1.3 \text{ m}^3 \cdot \text{g}^{-1} \cdot \text{s}^{-1}$  ( $0.16 \text{ volppm}^{-1} \cdot \text{min}^{-1}$ ) and  $k'^{\text{O}_3} = 0.7 \text{ m}^3 \cdot \text{g}^{-1} \cdot \text{s}^{-1}$  ( $0.08 \text{ volppm}^{-1} \cdot \text{min}^{-1}$ ). If the gas reactions inside the chamber are assumed to be  $\text{NO}_2 + \text{O}_3 \rightarrow \text{NO}_3 + \text{O}_2$  and  $\text{NO}_3 + \text{NO}_2 + \text{H}_2\text{O} \rightarrow 2 \text{HNO}_3$ , then the per unit volume reaction rate constants are obtained as follows:  $k'^{\text{NO}_2} = 0.164 \text{ volppm}^{-1} \cdot \text{min}^{-1}$  and  $k'^{\text{O}_3} = 0.082 \text{ volppm}^{-1} \cdot \text{min}^{-1}$  (10). These values are nearly equal to the results of experiments obtained in the chamber. It is thus inferred that most of the reaction products formed inside the chamber are a result of the reactions specified above. They are removed from the system together with the vapor that is fixed as a result of dehumidification by the heat exchanger.

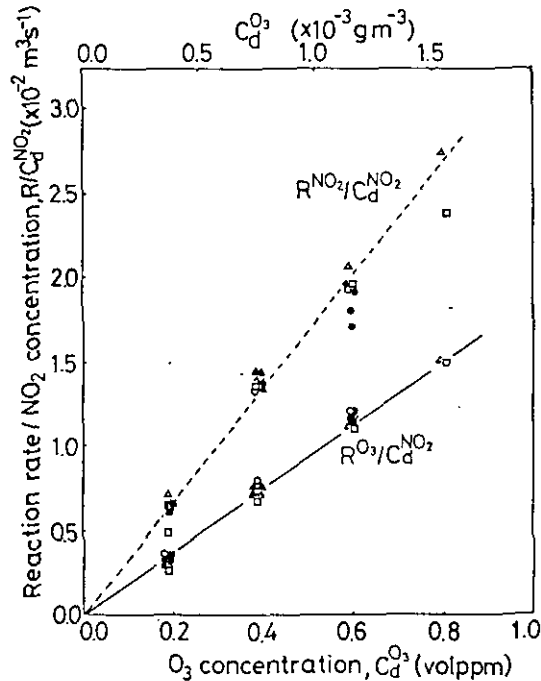

Fig. 5. Relation between  $\text{O}_3$  concentration ( $C_d^{\text{O}_3}$ ) and the ratio of reaction rate to  $\text{NO}_2$  concentration ( $R/C_d^{\text{NO}_2}$ ). The data are obtained from the results in Fig. 4.

*Effects of the air conditioning system on gas reactions*

The rate constants of gas reactions inside the chamber are slightly affected by changes in factors such as temperature and humidity of the air inside the chamber, and the temperature of the heat exchanger's coil surface (Experiment II). One example of the effect caused by changes in the air conditioning system is presented in Fig. 6, in which temperature of the air inside the chamber was raised from 25°C to 30°C in steps. A

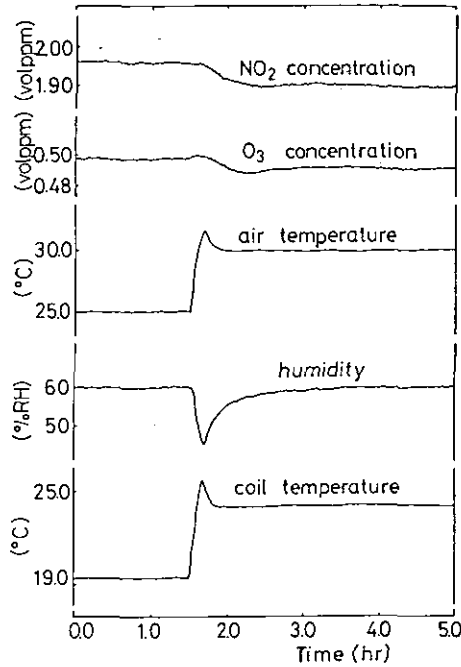

Fig. 6. Influence of air conditions on reactions of  $NO_2$  and  $O_3$ . Mass flow rates of  $NO_2$  and  $O_3$  ( $U$ ) were maintained constant.

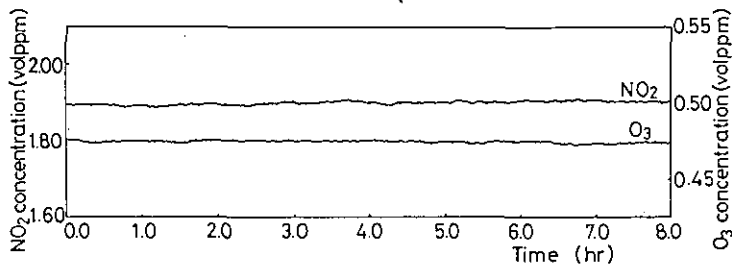

Fig. 7. Time course of  $NO_2$  concentration and  $O_3$  concentration, when air temperature, humidity, temperature on coil surface and mass flow rates of  $NO_2$  and  $O_3$  maintained constant.

## Analysis of air pollutant sorption by plants (2)

change in the temperature of the air inside the chamber gave rise to changes in humidity of the air, in the coil surface temperature and in the rate of dehumidification. The increase in the temperature of the chamber air by 5 °C was found to have caused changes in NO<sub>2</sub> concentration and O<sub>3</sub> concentration by 0.07 volppm and 0.01 volppm, respectively. Although this seems to be ascribable to various factors, like a change in rate constants of reactions and a change in the wet surface on the coil caused as a result of the temperature change, the real cause is not clear. However, as shown in Fig. 7, when factors such as temperature and humidity of the chamber air, coil surface temperature and humidity of fresh air were controlled at constant levels, no change in gas concentration levels, and therefore no change in rate constants of gas reactions was observed. In view of this fact, it became clear that in measuring gas sorption rate by plants, it is necessary to keep the conditions of air conditioning constant during the period of measurement. In addition it is necessary to determine for each experiment the rate constants of reactions, which are affected, though slightly, by the conditions of air conditioning. It is, however, easy to calculate rate constants of reaction by making use of the observations about gas reactions already explained. All that is needed is to insert in Eqs. (9) and (10) the values of gas concentration and the flow rate of gas added under situation *S*, i.e., under steady-state conditions prior to the placement of plants in the chamber.

### Evaluation of the precision of measurement

An equation for calculation of sorption rate for each gas ingredient during exposure of plants to gas mixture of NO<sub>2</sub> + O<sub>3</sub> can be obtained by combining Eqs. (6), (9) and (10). Since there are two pollutants are involved, the derived equation may be written in the form of a vector equation as follows.

$$\hat{P}_h = A \cdot x_h + B \cdot x_h + C \cdot z_h \quad (11)$$

where

$$\hat{P}_h = \begin{bmatrix} \Delta \hat{P}_h^{NO_2} \\ \Delta \hat{P}_h^{O_3} \end{bmatrix}, \quad x_h = \begin{bmatrix} \Delta \hat{C}_{d_h}^{NO_2} \\ \Delta \hat{C}_{d_h}^{O_3} \end{bmatrix}, \quad z_h = \begin{bmatrix} \Delta \hat{C}_{d_h}^{NO_2} - \Delta \hat{C}_{d_{h-1}}^{NO_2} \\ \Delta \hat{C}_{d_h}^{O_3} - \Delta \hat{C}_{d_{h-1}}^{O_3} \end{bmatrix},$$

$$A = \begin{bmatrix} -F & 0 \\ 0 & -F \end{bmatrix}, \quad B = \begin{bmatrix} -k^{NO_2} \cdot C_d^{O_3} & -k^{NO_2} \cdot C_d^{NO_2} \\ -k^{O_3} \cdot C_d^{O_3} & -k^{O_3} \cdot C_d^{NO_2} \end{bmatrix}_S, \quad C = \begin{bmatrix} -V/\tau & 0 \\ 0 & -V/\tau \end{bmatrix}$$

The reaction term  $B \cdot x_h$  and the differential term  $C \cdot z_h$  in Eq. (11) can be regarded as correction terms for improving the accuracy of measurement of gas sorption rates, but the functions of the two terms are completely different. According to Eq. (11), gas sorption rates can be derived by measuring the changes in gas concentration in the chamber; but changes in gas concentration levels are accompanied by corresponding changes in reaction rates, as it is clear from Eqs. (9) and (10). Therefore, in order to obtain the exact gas sorption rates, it is imperative to correct the errors due to the changes in reaction rates. The reaction term serves this purpose. It is effective in correcting the steady-state deviation caused by changes in reaction rates, that is to say in correcting the static characteristics. In contrast, gas concentration in the chamber, as indicated by Eq. (2), do

not react instantly to changes in sorption rates but with some time lag depending upon the inner volume of the chamber. Therefore, to obtain the exact gas sorption rates, it is necessary to correct errors due to the time lag. The differential term serves this purpose. It is effective in correcting transient deviations caused by delayed response of gas concentration levels, i.e. in correcting the dynamic characteristics. However, this correction, made by way of differential, is susceptible to noise. Generally, the reaction and differential terms do not exhibit the same levels of effectiveness but are affected by various conditions. In view of this an inquiry was made into the correction effects of the differential and reaction terms on the basis of the results of Experiments III and IV.

Fig. 8 offers an example of the correction effects of the reaction term obtained from Experiment III. Since the coefficient matrix  $B$  depends on gas concentration, the higher the level of gas concentration, the greater the correction effects of the term tends to become. In the example presented in Fig. 8, when the reaction term was not taken into consideration, errors in measurement  $(1 - \Delta P / \Delta U_{max})$  of sorption rates amounted to approximately 20% for  $\text{NO}_2$  and approximately 30% for  $\text{O}_3$ . By taking the reaction term

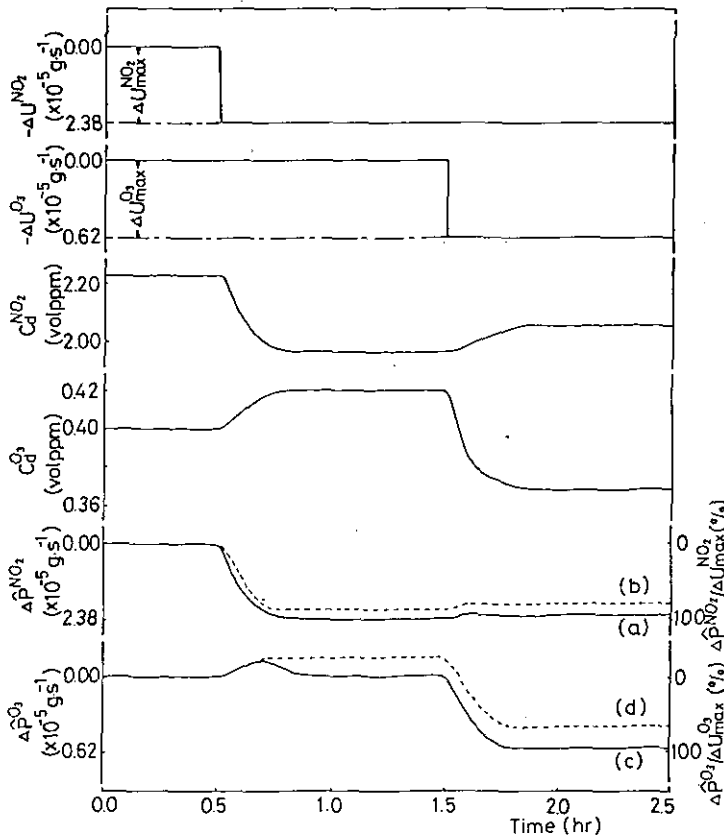

Fig. 8. Effect of reaction term ( $B \cdot x_h$ ) on sorption rate ( $\hat{P}_h$ ). The sorption rates of (a) and (c) are calculated from  $A \cdot x_h + B \cdot x_h$ , and those of (b) and (d) from  $A \cdot x_h$ .

Analysis of air pollutant corption by plants (2)

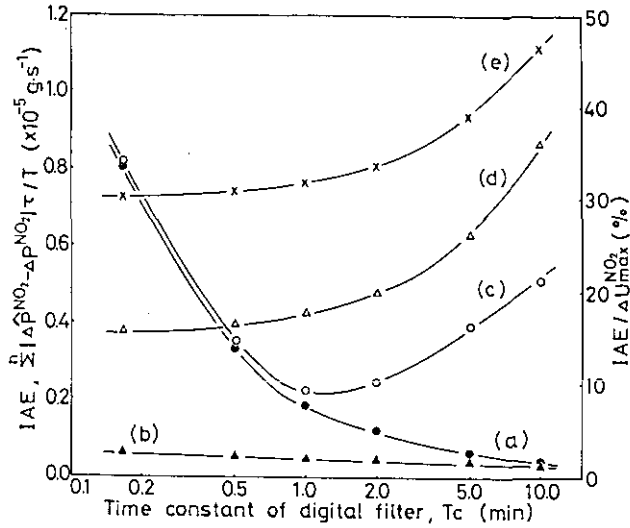

Fig. 9. Effect of differential term ( $C \cdot z_h$ ) on sorption rate ( $\hat{P}_h$ ). (a) and (b) are obtained in steady-state, and (c); (d) and (e) in transient conditions (Fig. 3), where the sorption rates of (a) and (c) are calculated from Eq. (11), those of (b) and (d) from  $A \cdot x_h + B \cdot x_h$ , and that of (e) from  $A \cdot x_h$ . Parameters:  $T_s$ , 30min;  $T_{ts}$ , 20min;  $\Delta U_{max}^{NO_2}$ ,  $2.4 \times 10^{-5} \text{ g} \cdot \text{s}^{-1}$ ;  $\text{NO}_2$  concentration,  $C_{d_s}^{NO_2}$ , 2.3 volppm;  $\text{O}_3$  concentration,  $C_{d_s}^{O_3}$ , 0.4 volppm

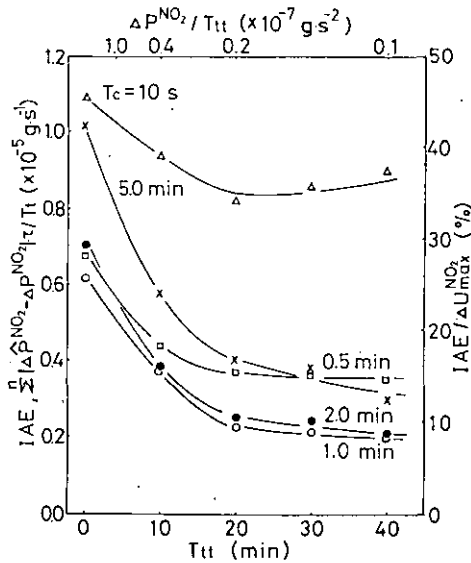

Fig. 10. IAE in transient conditions. The sorption rate is calculated from Eq. (11). Parameters:  $T_{ts}$  20 min;  $\Delta U_{max}^{NO_2}$   $2.4 \times 10^{-5} \text{ g} \cdot \text{s}^{-1}$ ;  $\text{NO}_2$  concentration,  $C_{d_s}^{NO_2}$ , 2.3 volppm;  $\text{O}_3$  concentration,  $C_{d_s}^{O_3}$ , 0.4 volppm.

into consideration, the errors under steady-state conditions were reduced to 5% or less for both  $\text{NO}_2$  and  $\text{O}_3$ . From this in the actual measurement of gas sorption rates, the reaction term will effectively reduce measurement errors.

On the other hand, the differential term is very susceptible to noise of the process and the gas analyzer. Thus in order to evaluate correction effects of the differential term, it is necessary to examine them concurrently with measures taken to reduce the noise. The effects of the differential term with respect to  $\text{NO}_2$  measurements was examined by Experiment IV. Fig. 9 represents relations between the time constant  $T_c$  of the digital filter used to reduce the noise in measurements and the correction effects of the differential term in steady-state or transient conditions. Under steady-state conditions, measurement errors were smaller when the differential term was not taken into consideration than when it was. This was especially so for a smaller time constant  $T_c$  of the digital filter. This indicates that when  $T_c$  is sufficiently small, the differential term acts as a disturbing, rather than correctional factor as it is influenced by the noise. When  $T_c$  becomes larger, however, the noise tends to be smoothed out, thus reducing measurement errors. Even under transient conditions, a similar tendency was observed for  $T_c < 1.0$  min. For  $T_c \geq 1.0$  min, measurement errors grew larger as  $T_c$  was increased. This is due to the fact that when  $T_c$  is significantly large, measurement errors are magnified due to time lag of the filter. It was found, however, that with the choice of an adequate  $T_c$ , the transient characteristics when the differential term is taken into consideration can be improved to be almost twice as much higher in terms of the measurement error evaluation criterion  $IAE/\Delta U_{max}^{\text{NO}_2}$  than when the differential term is not taken into consideration, and that measurement with an error of 10%  $IAE/\Delta U_{max}^{\text{NO}_2}$  or less is possible.

Also, an examination was made into how faithfully the measured values could trace various transient changes in sorption rates (Experiment IV). The result of the examination is summarized in Fig. 10. Here, as the transient characteristics in Fig. 9, measurement errors increased due to the effects of noise when the time constant  $T_c$  was small, and due to the effects of the time lag of the filter when  $T_c$  was large. The optimum  $T_c$  for this system was found to be  $T_c = 1 - 2$  min, irrespective of the magnitude of transient changes, represented by  $T_{tt}$  or by  $\Delta P^{\text{NO}_2}/T_{tt}$ . And it was found that with the choice of a filter with the optimum time constant, measurement is possible within an error of 10%  $IAE/\Delta U_{max}$  for transient changes of  $T_{tt} \approx 20$  min,  $\Delta P^{\text{NO}_2}/T_{tt} \cdot C_{d_s}^{\text{NO}_2} = 0.9 \times 10^{-8} \text{ g} \cdot \text{s}^{-2} \cdot \text{volppm}^{-1}$  or thereabout. Here,  $C_{d_s}^{\text{NO}_2}$  denotes  $\text{NO}_2$  concentration under situation  $S$ , that is to say under steady-state conditions prior to the placement of plants in the chamber.

#### Simultaneous measurement of the rates of transpiration and $\text{NO}_2$ and $\text{O}_3$ sorption by plants

The actual procedure by which the rates of air pollutant sorption by plants are measured is illustrated in Fig. 11. Before placing the plants in the chamber and measuring the rates of gas sorption, the air conditioning system, the flow rate of air exchange, the rate constants of reactions and other parameters must be determined. In an experiment with a type of gas, like  $\text{SO}_2$ , on which effects of cooling and dehumidification are not easy to grasp quantitatively, it is necessary to choose a control system that does not rely on cooling and dehumidification (13, 14). In an experiment with  $\text{NO}_2 + \text{O}_3$ , where the gas reactions including the ones having to do with cooling and dehumidification are



simulatable, an air conditioning system relying on cooling and dehumidification can be used. The flow rate of air exchange is calculated from the rate of gaseous exchange of the inert gases. The rate constants of the reactions must be determined on the basis of careful examination of the reactions of the gas to be measured; the constants in the case of  $\text{NO}_2 + \text{O}_3$  are calculated from Eqs. (9) and (10) making use of the knowledge about the reactions mentioned earlier. Only after these characteristics are properly grasped, and after making sure that gas concentrations in the chamber have reached a steady-state, the plants be placed in the chamber and measurement started. Upon completion of measurements, the plants are removed from the chamber, and it must be made sure that the gas concentrations have recovered the situation that prevailed before the plants were introduced. If the original situation is not recovered, we find out what is wrong with the system, rectify any deficiencies and repeat the experiment.

Following the above-mentioned procedure, the rates of transpiration and  $\text{NO}_2$  and  $\text{O}_3$  sorption by plants exposed to gas mixture of  $\text{NO}_2 + \text{O}_3$  were measured simultaneously. One example of the results of measurement is illustrated in Fig. 12. A change in the air pollutant sorption rate consequent upon plant reactions was at about  $1.5 \times 10^{-9} \text{ g}\cdot\text{s}^{-2}\cdot\text{volppm}^{-1}$  at the most. Judging from the result given in Fig. 10, this confirms that the method of measurement and the system described here are capable of tracing the actual gas sorption behavior of plants.

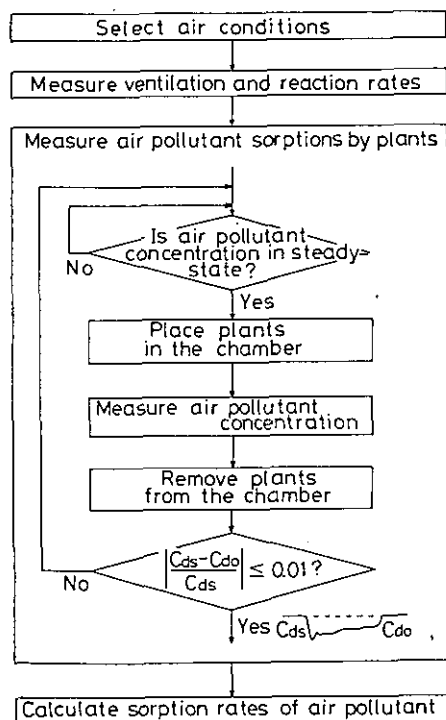

Fig. 11. Flow chart for simultaneous measurement of air pollutant sorptions.  $C_{ds}$  and  $C_{d_0}$  in the figure denote gas concentrations in steady-state.  $C_{d_0}$  is the initial value and  $C_{ds}$  is the value after plants are removed from the chamber.

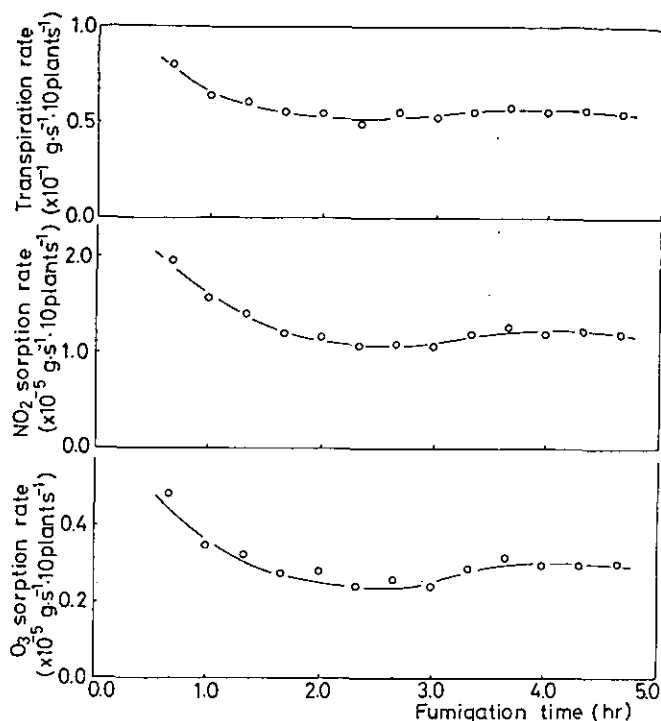

Fig. 12. Example of simultaneous measurement of transpiration rate,  $\text{NO}_2$  sorption rate and  $\text{O}_3$  sorption rate of plants. Conditions: air temperature,  $30^\circ\text{C}$ ; humidity, 60% RH; light intensity, 40 klux;  $\text{NO}_2$  concentration,  $C_{ds}^{\text{NO}_2}$ , about 2 volppm;  $\text{O}_3$  concentration  $C_{ds}^{\text{O}_3}$ , about 0.5 volppm.

We sincerely wish to thank Mr. S. Matsumoto of the Division of Engineering of our Institute for his valuable advice, and members of the Division of Engineering who took part in maintenance of the equipment and cultivation of plants used in the experiments.

This report is a reconstructed version of a paper (15) published in Journal of Agricultural Meteorology.

#### References

1. Aiga, I., K. Omasa and Y. Kobayashi: The environmental control system for plant experiment in National Institute for Environmental Studies. In *Examples of the newest air conditioning system*. P.315-363. Keiei Kaihatsu Center, Osaka, 1980.
2. Aoki, M.: A method to measure the dynamic response of net photosynthetic rate in the controlled-environment chamber. *J. Agr. Meteorol.* 34: 1-6 (1978).
3. Bennett, J.H. and A.C. Hill: Interactions of air pollutants with canopies of vegetation. In *Responses of plants air pollution*. Edited by J.B. Mudd and T.T. Kozlowski, p.273-306. Academic Press, New York, 1975.
4. Hashimoto, Y., K. Omasa and S. Funada: Direct digital control of air conditioning system in growth-cabinet for plant physiology (III). *Refrigeration, Japan*, 50: 792-805 (1975).
5. Hecht, T.A. and J.H. Seinfeld: Development and validation of a generalized mechanism for photochemical smog. *Environ. Sci. and Technol.* 6: 47-57 (1972).
6. Hemmi, P.: Temperatur-und Feuchteverhalten klimatisierter Räume. *Schweizerische Blätter für*

Analysis of air pollutant sorption by plants (2)

- Heizung und Lüftung*. Heft 1:8-14 (1969).
7. Hill, A.C.: A special purpose plant environmental chamber for air pollution studies. *J. Air Poll. Control Ass.* 17: 743-748 (1967).
  8. Hill, A.C.: Vegetation: a sink for atmospheric pollutants. *ibid.* 21: 341-346 (1971).
  9. Environment Agency: *Environmental white book*. p.121-206. Printing Bureau, Ministry of Finance, Japan, 1978.
  10. Kondo, J.: *Air pollution - Analysis and modelling of phenomena* -. p.129-202. Koronasha, Tokyo, 1975.
  11. Nakanishi, E., N.C. Pereira, L.T. Fan and C.L. Hwang: Simultaneous control of temperature and humidity in a confined space Part 1. *Build. Sci.* 8: 39-49 (1973)
  12. Japanese Association of Public Health. *A report of investigation of effects of air pollutants on plants*. p.115-129. *Jap. Ass. Public Health*. 1977.
  13. Omasa, K. and I. Aiga: Control of air pollutant concentration in an environmental chamber for plant experiments (I) *Proc. ann. meeting, Refrigeration (Tokyo)* 27-30 (1976).
  14. Omasa, K. and F. Abo: Studies of air pollutant sorption by plants. (I) Relation between local SO<sub>2</sub> sorption and acute visible leaf injury. *J. Agr. Meteorol.* 34: 51-58 (1978).
  15. Omasa, K., F. Abo and I. Aiga: A method for simultaneous measurement of NO<sub>2</sub> and O<sub>3</sub> sorptions by plants in environmental control chamber. *ibid.* 35: 31-40 (1979).
  16. Reinert, R. A., A. S. Heagle and W. W. Heck: Plant responses to pollutant combinations. In *Responses of plants to air pollution*. Edited by J. B. Mudd and T.T. Kozlowski. p.159-177. Press, New York, 1975.
  17. Rogers, H. H., H. E. Jeffries, E. P. Stahel, W. W. Heck, L. A. Ripperton and A. M. Witherspoon: Measuring air pollutant uptake by plants: a direct kinetic technique. *J. Air Poll. Control Ass.* 27: 1192-1197 (1977).
  18. Unsworth, M. H., P. V. Biscoe and V. Black: Analysis of gas exchange between plants and polluted atmospheres. In *Effects of air pollutants on plants* Edited by T. A. Mansfield. p.5-16. Cambridge University Press, London, 1976.
  19. Wellburn, A. R., T. M. Capron, H. S. Chan and D. C. Horsman: Biochemical effects of atmospheric pollutants on plants. In *Effects of air pollutants on plants*. Edited by T. A. Mansfield. p.105-114. Cambridge University Press, London, 1976.
  20. Yamazoe, F.: Effects of mixed air pollutants on plants. *The Heredity, Japan*, 30. No. 7: 31-36 (1976).

## Analysis of air pollutant sorption by plants

### (3) Sorption under fumigation with $\text{NO}_2$ , $\text{O}_3$ or $\text{NO}_2 + \text{O}_3$

Kenji Omasa<sup>1</sup>, Fumiaki Abo<sup>1</sup>, Toshiki Natori<sup>2</sup> and Tsumugu Totsuka<sup>2</sup>

<sup>1</sup> Division of Engineering, The National Institute for Environmental Studies, Yatabe, Ibaraki 305

<sup>2</sup> Division of Environmental Biology, The National Institute for Environmental Studies,  
Yatabe, Ibaraki 305

In order to investigate  $\text{NO}_2$  and  $\text{O}_3$  sorption by plants during fumigation with  $\text{NO}_2$ ,  $\text{O}_3$  and  $\text{NO}_2 + \text{O}_3$ , the principal gaseous pollutants, sunflower plants were fumigated with the gases in an environmental control chamber. The sorption rate, transpiration rate and leaf temperature were measured during fumigation, and the sorption processes were discussed by the use of a simplified model. The results obtained are as follows :

(1) The stomatal closure and the appearance of visible leaf injury on fumigation with a single gas ( $\text{NO}_2$  or  $\text{O}_3$ ) and a mixed gas ( $\text{NO}_2 + \text{O}_3$ ) were observed. The onset of these phenomena was related to the gas concentration, and the degree of injury increased with increasing gas concentration. The degree of injury was also dependent on the nature of the gas. In the case of fumigation with the single gas,  $\text{NO}_2$  and  $\text{O}_3$ , the  $\text{NO}_2$  concentration at which the phenomena began to appear was about ten times higher than that for  $\text{O}_3$ . In the case of fumigation with  $\text{NO}_2 + \text{O}_3$ , the phenomena appeared at the concentrations of  $\text{NO}_2$  and  $\text{O}_3$  lower than that for a single gas ( $\text{NO}_2$  or  $\text{O}_3$ ). The results obtained here may indicate one of the synergistic effects of air pollutants. The degree of injury for  $\text{NO}_2$  and  $\text{O}_3$  on the stomatal closure and the appearance of leaf injury, were distinctly in the order of  $\text{O}_3 > \text{SO}_2 > \text{NO}_2$ .

(2) The relations between  $Q/w'$  and  $P_a$  during fumigation with a single ( $\text{NO}_2$  or  $\text{O}_3$ ) or a mixed gas ( $\text{NO}_2 + \text{O}_3$ ) were expressed by equations of the form  $Q^{\text{NO}_2}/w' \simeq 1.4 \times 10^{-3} \cdot P_a^{\text{NO}_2}$ , and  $Q^{\text{O}_3}/w' \simeq 1.5 \times 10^{-3} \cdot P_a^{\text{O}_3}$ , where  $Q^{\text{NO}_2}$  and  $Q^{\text{O}_3}$  are the sorption rates of  $\text{NO}_2$  and  $\text{O}_3$ ,  $w'$  is the transpiration rate divided by the water vapor pressure difference between the gas-liquid interface in the leaf and the atmosphere, and  $P_a^{\text{NO}_2}$  and  $P_a^{\text{O}_3}$  are the gas concentration of  $\text{NO}_2$  and  $\text{O}_3$  in the atmosphere. These relations were independent of the gas components used for fumigation and the appearance of visible leaf injury. These empirical equations corresponded to those which were derived by using a simplified model,  $Q/w' = (k_w/k_g k_r)(P_a - P_i)$  at  $P_i = 0$  volppm, where  $P_i$  is the gas concentration at the gas-liquid interface in the leaf,  $k_r$  is the ratio of the gas diffusive resistance to that for water vapor,  $k_w$  is a constant:  $1.05 \times 10^6$  mmHg $\cdot$ cm $^3 \cdot$ g $^{-1}$ , and  $k_g$  is a constant:  $5.40 \times 10^8$  ( $\text{NO}_2$ ) or  $5.18 \times 10^8$  ( $\text{O}_3$ ) volppm $\cdot$ cm $^3 \cdot$ g $^{-1}$ . The calculated values of  $k_w/k_g k_r$  were coincident with the coefficients of  $Q/w'$  and  $P_a$ . From the results mentioned above, it was concluded that the  $\text{NO}_2$  and  $\text{O}_3$  concentrations at the gas-liquid interface in the leaf are effectively zero, and the  $\text{NO}_2$  and  $\text{O}_3$  sorption rates can be explained by factors such as the boundary layer and the stomatal resistances, which are related to gaseous diffusion.

**Key words:**  $\text{NO}_2$  -  $\text{O}_3$  - Mixed gas - Sorption process.

The importance of plant communities as a sink for air pollutants has been reported by many researchers (3, 13, 16). Sorption of pollutants by plants is controlled by the concentrations of pollutants in the atmosphere and those on the leaf surface and the diffusion resistance between the atmosphere and leaf. In order to elucidate the sorption mechanism of pollutants by plants and to formulate a prediction model of the sorption, it is necessary to examine those factors governing the sorption of pollutants.

It has been known that the diffusion of air pollutants in the boundary layer on the leaf surface and in the substomatal cavity, in the gaseous phase, may be treated in the same way as the diffusion of water vapor and CO<sub>2</sub> (2, 9, 16). However, studies on the boundary conditions concerning the gas concentration at the gas-liquid interface in the substomatal cavity are few. Recently, we pointed out problems concerning the boundary conditions for the leaf surface and examined these problems for SO<sub>2</sub> fumigation (10). There have, however, been no reports which have examined the boundary conditions for the leaf surface under fumigation with gaseous air pollutants (single or mixed gas), other than SO<sub>2</sub>, until injury appears on the leaf surface. In this report, we have attempted, experimentally, to study interrelation between the rates of leaf transpiration, NO<sub>2</sub> sorption and O<sub>3</sub> sorption until visible injury appears during NO<sub>2</sub>, O<sub>3</sub> or NO<sub>2</sub> + O<sub>3</sub> fumigation. An analysis of the boundary conditions for the gas concentration on the leaf surface until the leaf injury occurred has also been attempted using simple models. Further, previous results for an SO<sub>2</sub> study (10) are also discussed in relation to the present findings.

## Materials and methods

### *Materials*

Sunflower plants were used as experimental materials. The plants were grown in the Phytotron (daytime: 25°C; nighttime: 20°C; 70%RH; natural light) for 4–6 weeks (1500–2500 cm<sup>2</sup> leaf area/plant and 15–25 leaves/plant) after planting in pots (10 cm in diameter, 20 cm high) which were filled with the mixture of vermiculite, perlite, peatmoss and fine gravel at a ratio of 2:2:1:1 (v/v).

### *Equipment*

An controlled environmental chamber (1) was used to carry out the fumigation experiments. Temperature and humidity control inside the chamber were less than ± 0.5°C and ± 3%RH. The NO<sub>2</sub> and O<sub>3</sub> concentrations for the fumigation experiments were controlled within ± 0.5% of the desired values. The average wind velocity inside the chamber was 0.22 m·s<sup>-1</sup> and the intensity of illumination was 40 ± 5 klux at a position 1.3 m below the light source under full illumination. The gas analyzers for NO<sub>2</sub> and O<sub>3</sub> which are based on the chemiluminescent method were used for determining the NO<sub>2</sub> and O<sub>3</sub> concentrations.

### *Measuring methods*

In the case of NO<sub>2</sub> or O<sub>3</sub> fumigation, the gas sorption rate of the plants was measured as follows: A standard gas with a constant concentration was supplied to the chamber at a constant flow rate. After the gas concentration inside the chamber was constant, 10 sunflower plants were placed in the chamber and the sorption rate was measured from the subsequent change in gas concentration inside the chamber. On the other hand, in the case of NO<sub>2</sub> + O<sub>3</sub> fumigation, the concentration of one gas was maintained constant, and the sorption rate of the other gas was measured in the same way

as in the case of fumigation with a single gas. In this case, the quantities of  $\text{NO}_2$  and  $\text{O}_3$  to be lost for reactions inside the chamber were measured beforehand, and corrections were made for the calculation of the sorption rate (11). The transpiration rate was measured by the weighing method with a recording balance. The leaf temperature was measured by a copper-constantan thermocouple of 0.1 mm diameter.

#### Experiment methods

Experiment I – Simultaneous measurement of the leaf-air temperature difference and the transpiration rate of plants during the gas fumigation: For calculating the transpiration  $w'$  per unit water vapor pressure difference between the atmosphere and the interface in the substomatal cavity, the leaf temperature is necessary. An empirical equation for estimating the leaf temperature on the basis of the transpiration rate  $W$  and of the ambient air temperature was formulated from the results of the time courses of the transpiration rate and the leaf-air temperature differences during the  $\text{O}_3$  fumigation at 0.8 volppm for 3 hours after 2-hour fumigation at 0.4 volppm. The leaf-air temperature differences were measured by attaching 40 thermocouples on the surfaces of 40 leaves selected at random, and the average leaf temperature of five plants was calculated.

Experiment II – Simultaneous measurements of  $\text{NO}_2$  or  $\text{O}_3$  sorption rate and transpiration rate of plants: In order to investigate the relation between the  $\text{NO}_2$  or  $\text{O}_3$  sorption rate and the transpiration rate of plants during  $\text{NO}_2$ ,  $\text{O}_3$  and  $\text{NO}_2 + \text{O}_3$  fumigation, plants were exposed for about 5 hours to  $\text{NO}_2$  (0.2 – 6 volppm),  $\text{O}_3$  (0.2 – 0.8 volppm) and  $\text{NO}_2 + \text{O}_3$ , and the time courses of the sorption rate of  $\text{NO}_2$  and  $\text{O}_3$  and the transpiration rate per 10 plants were simultaneously measured.

### Experimental results and discussion

#### Nomenclature

$W$	: Transpiration rate on the leaf	$\text{g}\cdot\text{cm}^{-2}\cdot\text{s}^{-1}$
$T_a$	: Air temperature	$^{\circ}\text{C}$
$T_l$	: Leaf temperature	$^{\circ}\text{C}$
$\Delta T$	: Leaf-air temperature difference ( $T_l - T_a$ )	$^{\circ}\text{C}$
$Q$	: Gas sorption rate on the leaf	$\text{g}\cdot\text{cm}^{-2}\cdot\text{s}^{-1}$
$Q^{\text{NO}_2}$	: $\text{NO}_2$ sorption rate on the leaf	$\text{g}\cdot\text{cm}^{-2}\cdot\text{s}^{-1}$
$Q^{\text{O}_3}$	: $\text{O}_3$ sorption rate on the leaf	$\text{g}\cdot\text{cm}^{-2}\cdot\text{s}^{-1}$
$X_s(T)$	: Saturated vapor pressure at $T^{\circ}\text{C}$	mmHg
$\varphi$	: Relative humidity	
$w'$	: $W / \{ X_s(T_l) - \varphi X_s(T_a) \}$	$\text{g}\cdot\text{cm}^{-2}\cdot\text{s}^{-1}\cdot\text{mmHg}^{-1}$
$P_a$	: Atmospheric gas concentration	volppm
$P_a^{\text{NO}_2}$	: Atmospheric $\text{NO}_2$ concentration	volppm
$P_a^{\text{O}_3}$	: Atmospheric $\text{O}_3$ concentration	volppm
$P_l$	: Gas concentration at the gas-liquid interface in the leaf	volppm
$P_l^{\text{NO}_2}$	: $\text{NO}_2$ concentration at the gas-liquid interface in the leaf	volppm
$P_l^{\text{O}_3}$	: $\text{O}_3$ concentration at the gas-liquid interface in the leaf	volppm
$k_a$	: Proportional constant related to the structure of boundary layer on leaf surface, number of stomata, etc.	
$k_w$	: Saturated water vapor density/pressure conversion coefficient ( $1.05 \times 10^6$ )	$\text{mmHg}\cdot\text{cm}^3\cdot\text{g}^{-1}$ ( $30^{\circ}\text{C}$ )
$k_g$	: Unit conversion coefficient gas concentration	

	(NO <sub>2</sub> ; 5.40 × 10 <sup>8</sup> , O <sub>3</sub> ; 5.18 × 10 <sup>8</sup> , SO <sub>2</sub> ; 3.88 × 10 <sup>8</sup> )	volppm·cm <sup>3</sup> ·g <sup>-1</sup> (30°C)
$r_{wa}$	: Boundary layer resistance to water vapor	s·cm <sup>-1</sup>
$r_{ws}$	: Stomatal resistance to water vapor	s·cm <sup>-1</sup>
$r_{ga}$	: Boundary layer resistance to gas	s·cm <sup>-1</sup>
$r_{gs}$	: Stomatal resistance to gas	s·cm <sup>-1</sup>
$D_w$	: Air-water vapor diffusivity	cm <sup>2</sup> ·s <sup>-1</sup>
$D_g$	: Air-gas diffusivity	cm <sup>2</sup> ·s <sup>-1</sup>
$M_w$	: Molecular weight of water vapor	
$M_g$	: Molecular weight of gas	

*Relation between the Transpiration rate and leaf-air temperature difference of plants in the chamber*

For comparative studies of the mechanisms of gas sorption and transpiration of plants, it is necessary to perform simultaneous measurements of the leaf temperature in addition to the gas sorption rate and transpiration rate. However, it is very troublesome to measure the average leaf temperature of 10 plants by thermocouples whenever the gas sorption rate was measured in Experiment II. Therefore, we decided to derive an equation for estimating the leaf temperature. Fig. 1 shows the relation between the transpiration rate and the leaf-air temperature difference of plants during O<sub>3</sub> fumigation under constant conditions of light intensity, air temperature, humidity, wind velocity and plant arrangement. The transpiration rate  $W$  decreased and the leaf-air temperature difference  $\Delta T$  increased as the fumigation time elapsed. Furthermore, there was a linear relation between  $W$  and  $\Delta T$ , regardless of the kind of gas. Using this linear relation, the following equation was formulated for estimating the leaf temperature  $T_l$  from the transpiration rate  $W$  which was measured in Experiment II.

$$T_l = -6.4 \times 10^5 \cdot W + T_a + 2.2 \quad (1)$$

Although it is difficult to obtain an accurate value for the leaf temperature during gas

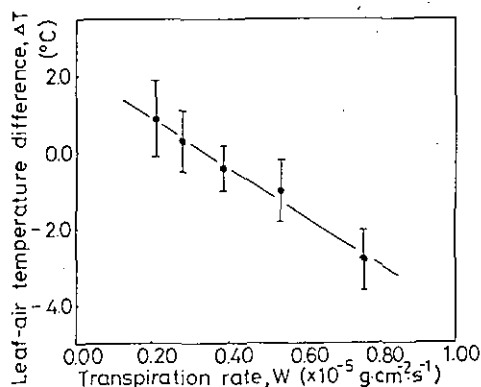

Fig. 1. Relation between transpiration rate ( $W$ ) and leaf-air temperature difference ( $\Delta T$ ) during O<sub>3</sub> fumigation. Each point is the mean value of data and vertical bars indicate standard deviation of each point. Conditions: air temperature, 30°C; humidity, 60% RH; light intensity, 40 klux.

Analysis of air pollutant sorption by plants (3)

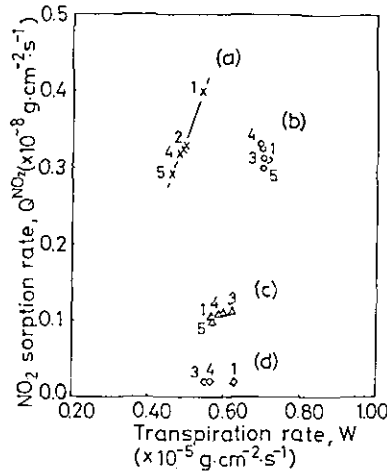

Fig. 2. Relation between  $NO_2$  sorption rate ( $Q^{NO_2}$ ) and transpiration rate ( $W$ ) during  $NO_2$  fumigation. The approximate  $NO_2$  concentration is 6 volppm (a), 4 volppm (b), 2 volppm (c) and 0.2 volppm (d). The fumigation time (min) is calculated from  $60 m_f - 20$ , where  $m_f$  indicates the number in the figure. Conditions: air temperature,  $30^\circ C$ , humidity, 55–60%RH; light intensity, 40 klux.

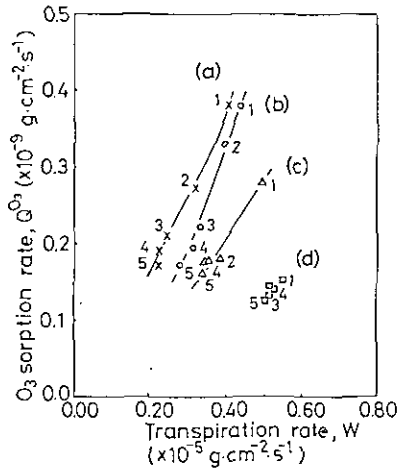

Fig. 3. Relation between  $O_3$  sorption rate ( $Q^{O_3}$ ) and transpiration rate ( $W$ ) during  $O_3$  fumigation. The approximate  $O_3$  concentration is 0.8 volppm (a), 0.6 volppm (b), 0.4 volppm (c) and 0.2 volppm (d). The fumigation time is calculated from the same equation as explained in Fig. 2. Conditions: air temperature,  $30^\circ C$ ; humidity, 60%RH; light intensity, 40 klux.



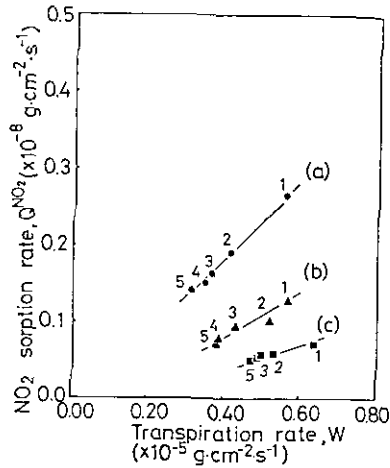

Fig. 4. Relation between  $NO_2$  sorption rate ( $Q^{NO_2}$ ) and transpiration rate ( $W$ ) during  $NO_2 + O_3$  fumigation. The approximate  $NO_2$  concentration is 4 volppm (a), 2 volppm (b) and 1 volppm (c). The  $O_3$  concentration is maintained constant (0.2 volppm). The fumigation time is calculated from the same equation as explained in Fig. 2, Conditions: air temperature, 30°C; humidity, 55–60%RH; light intensity, 40 klux.

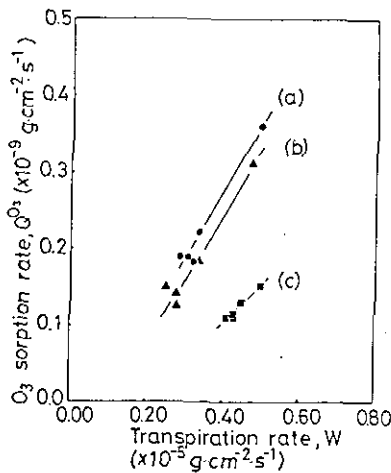

Fig. 5. Relation between  $O_3$  sorption rate ( $Q^{O_3}$ ) and transpiration rate ( $W$ ) during  $NO_2 + O_3$  fumigation. The approximate  $O_3$  concentration is 0.6 volppm (a), 0.45 volppm (b) and 0.2 volppm (c). The  $NO_2$  concentration is maintained constant (1.0 volppm). The fumigation time is calculated from the same equation as explained in Fig. 2. Conditions: air temperature, 30°C; humidity, 55–60%RH; light intensity, 40 klux.

fumigation in this method, the average leaf temperature can be approximated in order to calculate  $w'$ .

*Relation between NO<sub>2</sub> or O<sub>3</sub> sorption rate and transpiration rate*

In order to elucidate the mechanisms of NO<sub>2</sub> and O<sub>3</sub> sorption by plants, the relations between the gas sorption rate and the transpiration rate of sunflower plants during NO<sub>2</sub>, O<sub>3</sub> and NO<sub>2</sub> + O<sub>3</sub> fumigation were investigated (Experiment II). The relations between the gas sorption rate  $Q$  and transpiration rate  $W$  obtained by experiment are shown in Figs. 2 to 5. The relation between the NO<sub>2</sub> sorption rate  $Q^{NO_2}$  and  $W$  during NO<sub>2</sub> fumigation (0.2 – 6 volppm) is shown in Fig. 2, the relation between the O<sub>3</sub> sorption rate  $Q^{O_3}$  and  $W$  during O<sub>3</sub> fumigation (0.2 – 0.8 volppm) in Fig. 3, the relation between the NO<sub>2</sub> sorption rate  $Q^{NO_2}$  and  $W$  during NO<sub>2</sub> + O<sub>3</sub> fumigation (NO<sub>2</sub>: 1 – 4 volppm, O<sub>3</sub>: 0.2 volppm) in Fig. 4, and finally the relation between the O<sub>3</sub> sorption rate  $Q^{O_3}$  and  $W$  during NO<sub>2</sub> + O<sub>3</sub> fumigation (NO<sub>2</sub>: 1 volppm, O<sub>3</sub>: 0.2 – 0.6 volppm) in Fig. 5. The numbers ( $m_f$ ) 1, 2, 3, ... in the figure represent the fumigation period which is calculated from  $60 \cdot m_f - 20$  min ( $m_f = 1, 2, 3, \dots$ ).

Although the results obtained include the effects of changes in the gas concentrations at the time of measurement, unavoidable due to the measuring method applied here, it is considered that they represent experimental values for approximately constant gas concentrations. Time courses of the gas sorption rate and the transpiration rate under single or mixed gas fumigation depend on the nature of gases and the concentrations. In many instances, it was noted that these values showed a tendency to decrease as the fumigation time increased. The higher the gas concentration was, the larger was the degree of the decrease. When the meteorological conditions are maintained constant, the transpiration rate may be considered as an index of the stomatal aperture. Therefore, the stomatal closure due to the effect of air pollutants may be regarded as the principal cause of the above phenomenon. In each experiment for gas fumigation, gas concentrations which showed a definite tendency to decrease in the time course rates were 6 volppm NO<sub>2</sub> (Fig. 2), 0.4, 0.6 and 0.8 volppm O<sub>3</sub> (Fig. 3), 1, 2 and 4 volppm NO<sub>2</sub> and 0.2 volppm O<sub>3</sub> (Fig. 4), and 0.2, 0.45 and 0.6 volppm O<sub>3</sub> and 1.0 volppm NO<sub>2</sub> (Fig. 5).

Also, concerning visible injury on the surface of the leaf, though the degree of injury varied with the kind and the concentration of gas, presaging phenomena of necrosis such as a water-soaked appearance and a subsequent wilting of the leaf were observed. These phenomena began to appear after 4 hours fumigation with 6 volppm NO<sub>2</sub> (Fig. 2), after about 4 hours fumigation with 0.6 volppm O<sub>3</sub> and after about 2 hours fumigation with 0.8 volppm (Fig. 3), after about 3 hours fumigation with the mixed gas NO<sub>2</sub> + O<sub>3</sub> at 2 volppm of NO<sub>2</sub> and 0.2 volppm of O<sub>3</sub> (Fig. 4), and after about 4 hours fumigation with the mixed gas NO<sub>2</sub> + O<sub>3</sub> at 1.0 volppm NO<sub>2</sub> and 0.6 volppm O<sub>3</sub> (Fig. 5). In this experiment, visible injury did not occur during 5 hours fumigation at concentrations other than for those mentioned above.

From the above results, it can be said that in the case of a single gas fumigation, appearance of visible injury and stomatal closure were noticed for O<sub>3</sub> concentrations about 1/10 that of NO<sub>2</sub>. Also, in the case of mixed gas fumigation, the visible injury and the stomatal closure appeared at the concentrations of NO<sub>2</sub> and O<sub>3</sub> below the critical values for fumigation with the single gas. These phenomena are considered as "complex pollution effects".

In the case of SO<sub>2</sub>, visible leaf injury began to appear after 3 hours fumigation at 1

volppm and the stomata began to close at 0.65 volppm (10). From the results, concerning the harmful effects of  $\text{NO}_2$ ,  $\text{O}_3$  and  $\text{SO}_2$  on plants, that of  $\text{O}_3$  was the largest, followed by  $\text{SO}_2$  and  $\text{NO}_2$ . It must be stressed, however, that detailed consideration of the "complex pollution effects" in relation to the appearance of visible injury and stomatal closure is a subject to be studied in the future.

The relation between the gas sorption rate  $Q$  and the transpiration rate  $W$  presented in Fig. 2 to 5 includes the effects of the change in gas concentration at the time of measuring and leaf temperature increases due to the decrease of the transpiration rate. In order to eliminate such effects, the relation between  $Q/w'$  and the gas concentration  $P_a$  is figured, as shown in Fig. 6 and Fig. 7. Fig. 6 shows the relation between  $Q^{\text{NO}_2}/w'$  and  $P_a^{\text{NO}_2}$  during  $\text{NO}_2$  (Fig. 2) or  $\text{NO}_2 + \text{O}_3$  fumigation (Fig. 4), and in Fig. 7 the relation between  $Q^{\text{O}_3}/w'$  and  $P_a^{\text{O}_3}$  during  $\text{O}_3$  (Fig. 3) or  $\text{NO}_2 + \text{O}_3$  fumigation (Fig. 5) is given, where  $w'$  is obtained by:

$$w' = W / \{ X_s(T_l) - \varphi X_s(T_a) \} \quad (2)$$

The leaf temperature data necessary for calculating  $w'$  were obtained by Eq. (1) according to the method mentioned previously. It is shown in Fig. 6 and Fig. 7 that the relations expressed by  $Q^{\text{NO}_2}/w' \approx 1.4 \times 10^{-3} \cdot P_a^{\text{NO}_2}$  and  $Q^{\text{O}_3}/w' \approx 1.5 \times 10^{-3} \cdot P_a^{\text{O}_3}$  approximate to the relation between  $Q/w'$  and  $P_a$ , regardless of the appearance of visible leaf injury such as water-soaked symptoms and wilting, and of single or mixed gas fumigation. On account of these results, the processes of  $\text{NO}_2$  or  $\text{O}_3$  sorption of sunflower plants may be

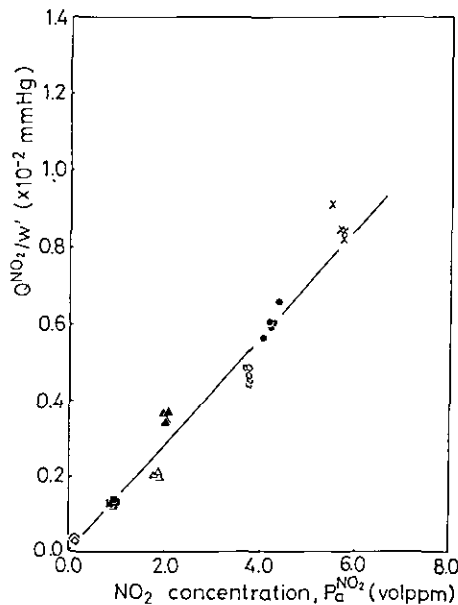

Fig. 6. Relation between  $\text{NO}_2$  concentration ( $P_a^{\text{NO}_2}$ ) and the ratio of  $\text{NO}_2$  sorption rate to transpiration rate divided by the water vapor pressure differences between gas-liquid interface in the leaf and the atmosphere ( $Q^{\text{NO}_2}/w'$ ). Data were obtained from the results shown in Figs. 2 and 4.

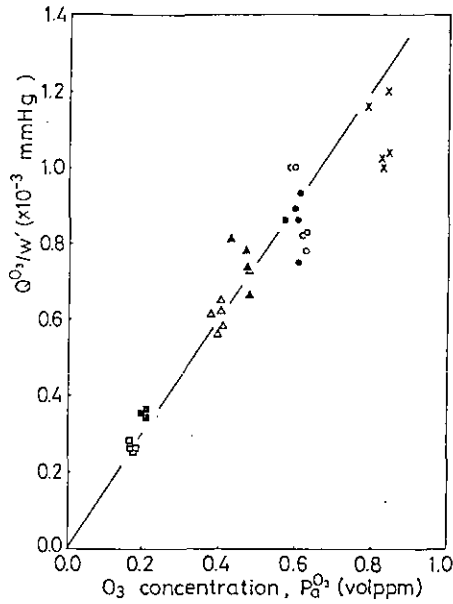

Fig. 7. Relation between  $O_3$  concentration ( $P_a^{O_3}$ ) and the ratio of  $O_3$  sorption rate to transpiration rate divided by the water vapor pressure differences between gas-liquid interface in the leaf and the atmosphere ( $Q^{O_3}/w'$ ). Data were obtained from the results shown in Figs. 3 and 5.

treated in the same way as that of transpiration on the leaf (4, 9).

*Analysis by sorption models*

Using simple models of the transpiration rate and the gas sorption rate on the leaf, the boundary conditions at the leaf surface for  $NO_2$  or  $O_3$  concentrations was examined. The transpiration rate and the gas sorption rate on the leaf are respectively approximated by the following equations:

$$W = k_a \cdot \{ X_s(T_l) - \varphi \cdot X_s(T_a) \} / \{ k_w \cdot (r_{wa} + r_{ws}) \} \quad (3)$$

$$Q = k_a \cdot (P_a - P_l) / \{ k_g \cdot (r_{ga} + r_{gs}) \} \quad (4)$$

where

$$r_{ga}/r_{wa} = (D_g/D_w)^{-2/3} \quad (5)$$

$$r_{gs}/r_{ws} = (D_g/D_w)^{-1} \quad (6)$$

It is known that the coefficients of mutual molecular diffusion of  $NO_2$ ,  $O_3$ , etc. in air can be expressed by the theoretical equation of Hirschfelder et al. (6) using Lennard-Jones's molecular model. Here,  $D_g/D_w$  was approximated by the next equation as a simplified form:

$$D_g/D_w = (M_g/M_w)^{-1/2} \quad (7)$$

Although Eq. (7) is a simplified equation, it is in comparatively good agreement with the values obtained from the coefficients of mutual molecular diffusion (7, 15) for various gas compositions in air.

To facilitate the comparison of the calculated  $Q/w'$  with experimental results, the following equation was introduced from Eqs. (2) to (4) by assuming  $r_{ga}/r_{wa} = r_{gs}/r_{ws} = k_r$ :

$$Q/w' = (k_w/k_g k_r) (P_a - P_l) \quad (8)$$

Table 1 Comparison between the values of  $k_w/k_g k_r$  which were calculated from equation (8) and the coefficients of  $Q/w'$  and  $P_a$  which were obtained by experiment. The values of  $k_w/k_g k_r$  for  $\text{NO}_2$ ,  $\text{O}_3$  and  $\text{SO}_2$  were calculated by assuming  $r_{ga}/r_{wa} = r_{gs}/r_{ws} = k_r$ . The coefficients of  $Q/w'$  and  $P_a$  for  $\text{NO}_2$  and  $\text{O}_3$  were obtained from the data in Figs. 6 and 7 and the coefficient for  $\text{SO}_2$  was obtained from literature data (10).

	$r_{ga}/r_{wa}$	$r_{gs}/r_{ws}$	$k_w/k_g k_r$		$Q/w'P_a$ (experiment)
			$k_r = r_{ga}/r_{wa}$ (mmHg·volppm <sup>-1</sup> )	$k_r = r_{gs}/r_{ws}$ (mmHg·volppm <sup>-1</sup> )	
$\text{NO}_2$	1.37	1.60	$1.42 \times 10^{-3}$	$1.22 \times 10^{-3}$	$1.4 \times 10^{-3}$
$\text{O}_3$	1.39	1.64	$1.46 \times 10^{-3}$	$1.24 \times 10^{-3}$	$1.5 \times 10^{-3}$
$\text{SO}_2$	1.53	1.89	$1.77 \times 10^{-3}$	$1.43 \times 10^{-3}$	$1.8 \times 10^{-3}$

The calculated values of  $k_w/k_g k_r$  of Eq. (8) for  $\text{NO}_2$ ,  $\text{O}_3$  and  $\text{SO}_2$  are shown in Table 1. The proportional constants between  $Q/w'$  and  $P_a$  for  $\text{NO}_2$ ,  $\text{O}_3$  and  $\text{SO}_2$  which were obtained from Fig. 6, Fig. 7 and the literature (10), are also shown in Table 1. The calculated values of  $k_w/k_g k_r$  for  $\text{NO}_2$ ,  $\text{O}_3$  and  $\text{SO}_2$  are roughly in agreement with the proportional constants obtained by the experiment.

The foregoing results show that regardless of the appearance of visible injury, and of single or mixed gas fumigation, the boundary condition concerning the gas concentration of  $\text{NO}_2$  and  $\text{O}_3$  at the leaf interface, can be assumed as  $P_l^{\text{NO}_2} \approx 0$  volppm and  $P_l^{\text{O}_3} \approx 0$  volppm as in the case of  $\text{SO}_2$ , and that  $\text{NO}_2$  and  $\text{O}_3$  sorption rates are governed by factors involved in the diffusion in the gaseous phase such as the boundary layer resistance, stomatal resistance, etc.. Rich et al. (14) have measured the stomatal resistance to water vapor diffusion in bean leaves and the  $\text{O}_3$  sorption rate when dark conditions were replaced by light conditions during  $\text{O}_3$  fumigation, and have reported that the stomatal resistance was the major factor governing  $\text{O}_3$  sorption. On the basis of the experimental results with alfalfa canopy, fumigated with different kinds of air pollutants (single) for 1 to 2 hours, Hill (5) compared the solubility in water of these air pollutants with gas sorption rates of the canopy, and has reported that gases having higher solubility had, in general, greater gas sorption rates. Since Hill's experiment has been performed without measurement of the boundary layer resistance and stomatal resistance, etc., comparison with our data cannot be made directly. But the reported sorption rates of  $\text{NO}_2$  and  $\text{O}_3$  were roughly coincident with our data. Bennett et al. (2) have proposed a

gas sorption model based on Henry's law on the gas-liquid equilibrium to define the boundary conditions at the leaf interface; they reported the importance of gas solubility in the process of gas sorption by plants and the concentration of the solution in the gas-liquid interface which was related to solubility. However, the mechanism of gas sorption by plants cannot be explained only in terms of the solubility of air pollutants in water. As for SO<sub>2</sub> with comparatively high solubility in water, SO<sub>2</sub> sorption of sunflower plants amounted to about  $1.4 \times 10^{-5} \text{ g}\cdot\text{cm}^{-2}$  after 5 hours of fumigation at 1.5 volppm, as reported by Omasa and Abo (10). Assuming that the fresh weight of sunflower leaves used for the experiment (ca.  $0.03 \text{ g}\cdot\text{cm}^{-2}$ ) consisted entirely of water, the SO<sub>2</sub> concentration at the interface will be about  $1.5 \times 10^3$  volppm, from the gas-liquid equilibrium of the solubility in water (8). This value is extremely high as compared with the fumigation concentration of 1.5 volppm. In the case of O<sub>3</sub> or NO<sub>2</sub>, solubility (the capacity of decomposition in the case of NO<sub>2</sub>) is less than that of SO<sub>2</sub>, and the estimated gas concentration at the interface will be even higher than the case of SO<sub>2</sub>.

The above mentioned results suggest that the principal factor governing the boundary conditions for the gas concentration at the leaf interface, namely, the concentration in solution, is not the solubility in water but rather is related to physiological functions such as metabolism, transfer, etc., which reduce the concentration of the solution within the plant body. On the other hand, Hill's results (5) suggest that the solubility in water has a direct or indirect effect on the functions causing a lowering of the concentration of the solution at the leaf interface. From the above mentioned discussions, it might be concluded that physiological activities function to decrease the concentration of the solution at the leaf interface ( $P_l$ ) to 0 volppm until the leaf injury such as water-soaked and wilting of the leaf is observed.

We sincerely wish to thank Dr. I. Aiga, group manager of the Division of Engineering of our Institute and Dr. A. Furukawa of the Division of Environmental Biology and members of the Division of Engineering who took part in the maintenance of equipments and the cultivation of plants used in the experiments.

This report is a reconstructed version of a paper (12) published in Journal of Agricultural Meteorology.

#### References

1. Aiga, I., K. Omasa and Y. Kobayashi: The environmental control system for plant experiment in National Institute for Environmental Studies. In *Examples of the newest air conditioning system*, p. 315-363. Kaihatsu Center, Osaka, 1980.
2. Bennett, J., A. C. Hill and D. M. Gates: A model for gaseous pollutant sorption by leaves. *J. Air Poll. Control Ass.* 23: 957-962 (1973).
3. Bennett, J. H. and A. C. Hill: Interactions of air pollutants with canopies of vegetation. In *Responses of plants to air pollution*. Edited by J. B. Mudd and T. T. Kozlowski: p. 273-306. Academic Press, New York, 1975.
4. Haseba, T.: Agro-meteorological studies of transpiration in plant leaf in relation to the environment. *Mem. Coll. Agri., Ehime Univ.* 18:1-141 (1973).
5. Hill, A. C.: Vegetation: a sink for atmospheric pollutants. *J. Air Poll. Control Ass.* 21: 341-346 (1971).
6. Hirschfelder, J. O., C. F. Curtiss and R. B. Bird: *Molecular theory of gases and liquids*. John Wiley & Sons, New York, 1954.
7. The Society of Chemical Engineers, Japan: *Physical properties data 8*. p.229-230, Maruzen, Tokyo, 1971.
8. Landolt-Börnstein: *Zahlenwerte und Funktionen aus Physik, Chemie, Astronomie, Geophysik und Technik*. 6 Auflage, II Band, 2 Teil, Bandteil b, Lösungsgleichgewichte 1, p. 1-26. Springer-

- Verlag, Berlin, 1962.
9. Monteith, J. L: *Principles of environmental physics*. p. 134–189. Edward Arnold, London, 1973.
  10. Omasa, K. and F. Abo: Studies of air pollutant sorption by plants. (I) Relation between local  $\text{SO}_2$  sorption and acute visible leaf injury. *J. Agr. Meteorol.* 34: 51–58 (1978).
  11. Omasa, K., F. Abo and I. Aiga: A method for simultaneous measurement of  $\text{NO}_2$  and  $\text{O}_3$  sorptions by plants in environmental control chamber. *J. Agr. Meteorol.* 35:31–40 (1979).
  12. Omasa, K., F. Abo, T. Natori and T. Totsuka: Studies of air pollutant sorption by plants. (II) Sorption under fumigation with  $\text{NO}_2$ ,  $\text{O}_3$  or  $\text{NO}_2 + \text{O}_3$ : *ibid.* 35: 77–83 (1979).
  13. Rasmussen, K. H., M., Taheri and R. L. Kabel: Global emissions and natural processes for removal of gaseous pollutants. *Wat., Air and Soil Poll.* 4:33–64 (1975).
  14. Rich, S., P. E. Waggoner and H. Tomlinson: Ozone uptake by bean leaves. *Science* 169: 79–80 (1970).
  15. H. Uchida: *Moist air and cooling tower*. p. 73. Syokabo, Tokyo, 1972.
  16. Unsworth, M. H., P. V. Biscoe and V. Black: Analysis of gas exchange between plants and polluted atmospheres. In *Effects of air pollutants on plants*. Edited by T. A. Mansfield. p. 5–16. Cambridge University Press, London, 1976.

## Remote sensing of the physiological functions of plants by infrared color aerial photography (I): Relations between leaf reflectivity ratio, bi-band ratio and photosynthetic function of leaves in several woody plants

Masatoshi Aoki<sup>1</sup>, Kazutoshi Yabuki<sup>1</sup> and Tsumugu Totsuka<sup>2</sup>

<sup>1</sup> College of Agriculture, University of Osaka Prefecture, Sakai, Osaka 591

<sup>2</sup> Division of Environmental Biology, The National Institute for Environmental Studies,  
Yatabe, Ibaraki 305

(1) The relation between the reflection characteristics of leaves and the chlorophyll content was investigated in several woody plants to obtain basic data for estimating photosynthetic functions by aerial infrared color photography. The chlorophyll content of a leaf was estimated with a standard error of less than 10% of the average chlorophyll content of healthy leaves by utilizing the reflectivity ratios,  $rNI'/rR'$  and  $rNI'/rG'$ , where  $rNI'$ ,  $rR'$  and  $rG'$  are the reflectivities at 800 nm, 630 nm, and 550 nm respectively.

(2) The color development characteristics of the film were examined and suitable wavelengths for analysis were determined to be 455 nm (B), 550 nm (G) and 620 nm (R).

(3) The bi-band ratios of R/B and R/G on the film correlated highly with the corresponding reflectivity ratios,  $rNI'/rG'$  and  $rNI'/rR'$ . It was found that R/B and R/G can be utilized as indices of the chlorophyll content of leaves.

(4) The relations between the bi-band ratio and the photosynthetic functions of a leaf as expressed by the chlorophyll content and the net photosynthetic rate were investigated for various tree species. It was shown that suitable bi-band ratios for estimating the photosynthetic functions of the leaf are R/G, R/B and R/BG (BG: 491 nm band), but R/G is the most suitable ratio.

(5) The chlorophyll content in a healthy leaf was estimated by the bi-band ratio R/G with an estimation error of about 10% of the average chlorophyll content of healthy leaves.

**Key words:** Remote sensing – Bi-band ratio – Chlorophyll content – Photosynthetic rate – Woody plants

Aerial infrared color photography has recently been used for the remote sensing of the injury to plant physiological functions caused by environmental pollution because of its suitability for surveying over a wide area. The technique of remote sensing as applied to plant physiological studies is based on changes in spectral reflectivity of leaves due to the reduction of their physiological functions. It is said that leaf reflectivity at the green wavelength region increases and that at the near infrared region decreases with a decrease in physiological functions of the leaves. So that an increase of the reflectivity ratio (green/infrared) might result if there was reduced physiological functions. Since infrared color film is sensitive to radiation extending from the green to near infrared regions, the ratio of leaf reflectivity can be estimated by analysis of the color tone on an infrared color photograph. The ratio of the color tone is generally designated as 'the bi-band ratio'



for the remote sensing method, and has been used as an indicator of physiological functions of plants (4). However, causal analyses of leaf reflectivity and physiological function has not yet been achieved.

The aim of the present paper is to clarify the relationship between the characteristics of the reflection of leaves and their physiological functions. The following problems were investigated using leaves of woody plants: The relation between (1) the chlorophyll content of leaves and spectral characteristics of reflection, (2) the spectral characteristics of reflection and color development of the infrared film, and (3) the bi-band ratio and photosynthetic function of leaves.

### Materials and methods

For studies on the spectral reflectivity and the chlorophyll content of leaves, samples in seven species of woody plants were obtained from trees grown in the campus of the University of Osaka Prefecture. Species of the plants tested are usually placed along roads and often planted in green belted areas. The species were camphor tree (*Cinnamomum camphora* Sieb.), Japanese viburnum (*Viburnum Awabuki* K.Koch), Japanese zelkova (*Zelkova serrata* Makino), plane tree (*Platanus orientalis* L.), oleander (*Nerium indicum* Mill), poplar (*Populus nigra* L.) and common catalpa (*Catalpa bignonioides* Walt.). Five to six trees were selected for each species as a test plant, and three to six leaves were sampled from each tree. For the measurement of the reflection spectrum, the leaf surface was wiped with tissue paper.

A Cary 17 DX Spectralphotometer (Varian Co. Ltd.) was used for the measurement of the reflection spectrum. The central part at the right-hand side of the midrib of the leaf was attached to the window of the measurement cell (0.5 cm × 1 cm) and the adaxial reflection spectrum was recorded by wavelength scanning from 400 nm to 2300 nm at speed of 5 nm·s<sup>-1</sup> (400 – 900 nm) and 10 nm·s<sup>-1</sup> (900 – 2300 nm). The spectral reflectivity (%) at 450 nm (rB'), 550 nm (rG'), 630 nm (rR') and 800 nm (rNI') was read from the chart recorder, and the reflectivity ratios were calculated from the data.

Immediately after measuring the reflection spectrum of the leaf, the chlorophyll content was measured by the Smith-Benitez method (6). Ten disks of area 1 cm<sup>2</sup> were punched out from the leaf and homogenized to extract chlorophyll. The content of chl. *a* + chl. *b* was measured by colorimetry and expressed as μg·cm<sup>-2</sup>.

In another experiment, leaves which were arranged on white cardboard were photographed by infrared color positive film under various exposure conditions in artificial and natural light. Next, the chlorophyll content of the leaves were determined by the method mentioned above. Kodak Ektachrome Infrared Film (IE 135-20) and a Nikon camera (Nikommat EL; lens: Micro-Nikkor-P, 1:3.5, f = 55 mm) were used for photography. A Kodak Wratten geratin filter (No. 12) was mounted in front of the lens to exclude radiation of wavelength shorter than 500 nm. Natural light and artificial light (Iwasaki Co. Ltd., type PRF 500 W; 5900 K in color temperature) were used for lighting. Light exposure by specular reflection of a leaf was avoided. The photography was carried out under various levels of exposure. And for the determination of the bi-band ratio, overexposures of 1.5 – 2.0 times more than that indicated by the built-in light meter were used.

A micro-densitometer (Photo Pattern Analyzer, Model: PPA-250, Applied Electric Lab. Co. Ltd., Tokyo) was used for the analysis of the infrared color positive photograph.

The output voltages due to light transmission on a leaf image were measured by mounting interference filters on the micro-densitometer. The measurement area was 0.2 mm × 0.2 mm on the leaf image, and the output voltages were averaged by scanning on the leaf image avoiding the part where specular reflection occurred.

Sometimes the reflection spectrum of a leaf was also measured before photography to examine the relation between the spectral reflectivity and the bi-band ratio.

The spectral characteristics of color development of the infrared color positive film were investigated with various interference filter (half width: 9 – 16 nm). The reflection spectra of the developed color images were compared with the peak wavelength of the interference filters.

When the relation between the net photosynthetic rate of leaves and the bi-band ratio was examined, the photographing of the leaf was carried out immediately after the measurements of the net photosynthetic rate. The net photosynthetic rate of a detached leaf was measured in an assimilation chamber (15 × 20 cm<sup>2</sup>, 4 cm deep) under controlled environments of air temperature 25°C (or 20°C), relative humidity 80%, 400 ppm CO<sub>2</sub> concentration, air velocity of 3.3 cm·s<sup>-1</sup> and short wave radiation of 0.3 (or 0.25) cal·cm<sup>-2</sup>·min<sup>-2</sup>.

### Results and discussion

#### *Relation between spectral reflectivity and chlorophyll content of leaf*

Reflection spectra of the camphor tree leaf with various leaves of chlorophyll content in February 1979 are shown in Fig. 1. The reflectivity at 500–600 nm, especially at around 550 nm, increased remarkably with decreasing chlorophyll content. At around

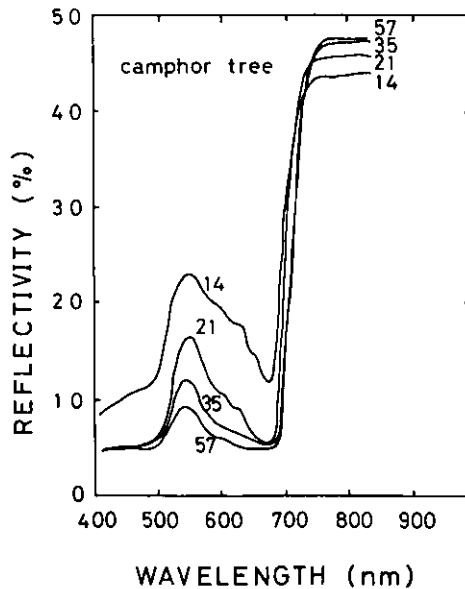

Fig. 1. Effects of chlorophyll content on the reflection spectrum of a leaf. Numerals in the figure show the chlorophyll content ( $\mu\text{g}\cdot\text{cm}^{-2}$ ).

800 nm, a region where chlorophyll does not absorb radiation, the spectral reflectivity decreased only slightly even when the chlorophyll content decreased from 57 to  $14 \mu\text{g}\cdot\text{cm}^{-2}$ .

Fig. 2 shows the relations between the spectral reflectivities at 450 nm ( $rB'$ ), 550nm ( $rG'$ ), 630 nm ( $rR'$ ) and 800 nm ( $rNI'$ ) and the chlorophyll content of the camphor tree. There was a distinct difference in the relations between  $rG'$  and  $rR'$  and between  $rNI'$  and  $rB'$ . In the former, the reflectivity increased almost exponentially with a decrease in

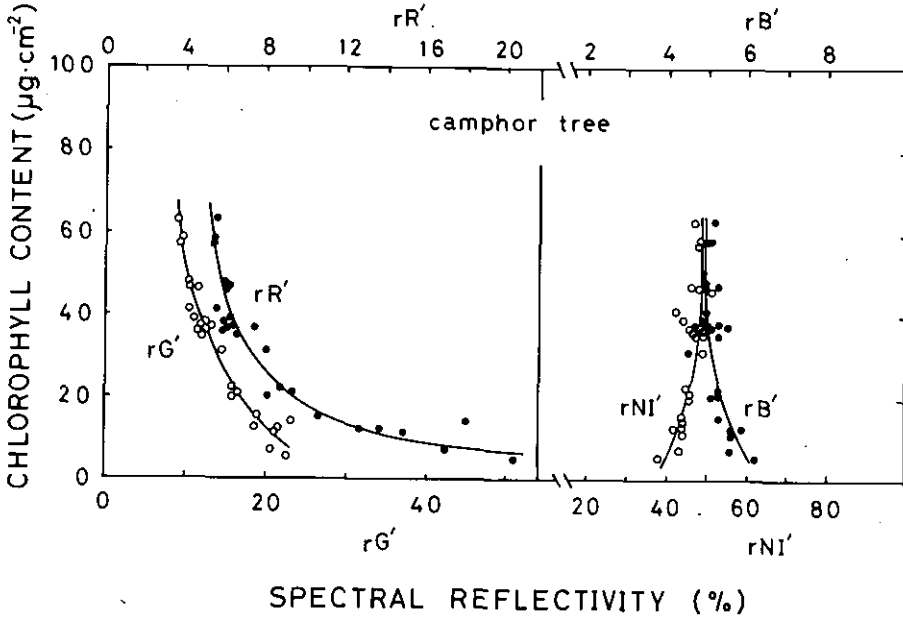

Fig. 2. Relation between the spectral reflectivity and the chlorophyll content.  $rB'$ ,  $rG'$ ,  $rR'$  and  $rNI'$  denote the spectral reflectivity at 450 nm (B'), 550 nm (G'), 630 nm (R') and 800 nm (NI') respectively.

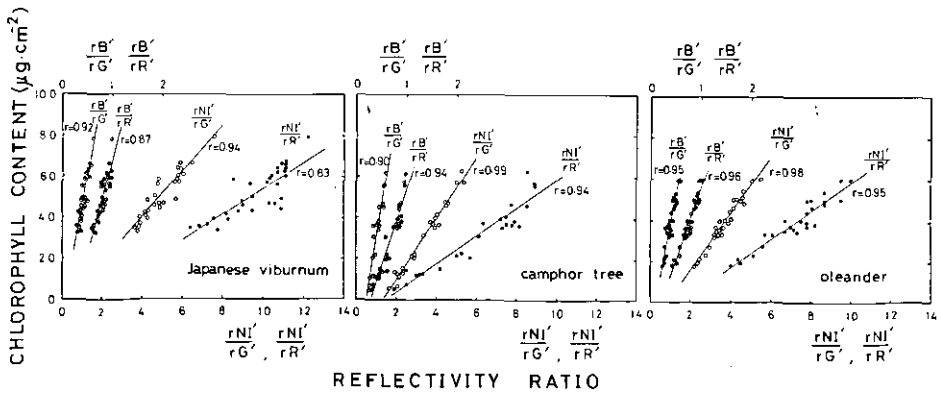

Fig. 3. Relation between the reflectivity ratio of the leaf and the chlorophyll content in Japanese viburnum, camphor tree and oleander.  $rB'$ ,  $rG'$ ,  $rR'$  and  $rNI'$  are the same as those in Fig. 2. Numerals in the figure show the correlation coefficients ( $r$ ).

chlorophyll content, while in the latter groups the reflectivity was almost constant except at low chlorophyll contents (below  $30 \mu\text{g}\cdot\text{cm}^{-2}$ ). Similar relations to those in Fig. 2 were obtained for other species.

The relations between the chlorophyll content and the reflectivity ratios selected from the few wavelengths previously mentioned were examined in Japanese viburnum, camphor tree and oleander in February 1979. As shown in Fig. 3, the reflectivity ratios of  $r_{NI}/r_{R'}$ ,  $r_{NI}/r_{G'}$ ,  $r_{B'}/r_{G'}$  and  $r_{B'}/r_{R'}$  showed a linear relation to the chlorophyll content with correlation coefficients being greater than 0.83. On the other hand, the reflectivity

Table 1 Correlation coefficients for the relation between the leaf reflectivity ratio and the chlorophyll content in camphor tree, oleander and Japanese viburnum.

reflectivity ratio	camphor tree (n = 25)	oleander (n = 27)	Japanese viburnum (n = 29)
$r_{NI}/r_{G'}$	*0.99 (2.5 $\mu\text{g}\cdot\text{cm}^{-2}$ )	*0.98 (2.4 $\mu\text{g}\cdot\text{cm}^{-2}$ )	*0.94 (4.1 $\mu\text{g}\cdot\text{cm}^{-2}$ )
$r_{NI}/r_{R'}$	*0.94 (5.6 " )	*0.95 (3.8 " )	*0.83 (6.7 " )
$r_{B'}/r_{G'}$	*0.90 (7.5 " )	*0.95 (3.7 " )	*0.92 (4.8 " )
$r_{B'}/r_{R'}$	*0.94 (5.7 " )	*0.96 (3.5 " )	*0.87 (5.8 " )
$r_{NI}/r_{B'}$	0.63 (13.3 " )	0.32 ( - )	0.21 ( - )
$r_{R'}/r_{G'}$	-0.43 ( - )	-0.09 ( - )	0.56 ( - )

Symbols are as in Fig. 2. n is the sample size. Numerals in parentheses show the standard estimation error calculated from the regression line. \* shows high linearity.

Measurements in 1979

ratios  $r_{NI}/r_{B'}$  and  $r_{R'}/r_{G'}$  correlated poorly with chlorophyll content, because the reflectivities  $r_{NI}$  and  $r_{B'}$  and also  $r_{R'}$  and  $r_{G'}$  responded very similarly to changes in chlorophyll content (cf. Fig. 2).

The correlation coefficients ( $r$ ) for the relation between the chlorophyll content and reflectivity ratios calculated for the different combinations of spectral reflectivity are indicated in Table 1 for three plant species. Four reflectivity ratios ( $r_{NI}/r_{G'}$ ,  $r_{NI}/r_{R'}$ ,  $r_{B'}/r_{G'}$  and  $r_{B'}/r_{R'}$ ) showed a high correlation coefficient ( $r > 0.83$ ) in every species. Especially, for  $r_{NI}/r_{G'}$  and  $r_{NI}/r_{R'}$  the linear relation was clearly indicated. Those reflectivity ratios exhibited marked variations with changes in chlorophyll content. Therefore, the ratios  $r_{NI}/r_{G'}$  and  $r_{NI}/r_{R'}$  seem to be the most suitable for estimation of the chlorophyll content. The standard estimation errors of the chlorophyll content evaluated for the regression lines between the ratios  $r_{NI}/r_{G'}$  and  $r_{NI}/r_{R'}$  were 0.25 ( $5.6 \mu\text{g}\cdot\text{cm}^{-2}$  chlorophyll), 2.4 ( $3.8 \mu\text{g}\cdot\text{cm}^{-2}$  chlorophyll) and 4.1 ( $6.7 \mu\text{g}\cdot\text{cm}^{-2}$  chlorophyll) respectively for camphor tree, oleander and Japanese viburnum. Since the average chlorophyll content of healthy leaves was about  $60 \mu\text{g}\cdot\text{cm}^{-2}$  for Japanese viburnum and about  $50 \mu\text{g}\cdot\text{cm}^{-2}$  for camphor tree and oleander, the standard errors are equivalent to less than about 10% of the content in these trees. In the case of  $r_{NI}/r_{R'}$ , the regression lines were approximately the same for the three species.

The major cause of error mentioned above would seem to be due to variations in the thickness of leaf. As indicated in Fig. 3, the correlation coefficients between the reflectivity ratio and the chlorophyll content were slightly smaller in Japanese viburnum

than those in the other two species. The leaf thickness of the former plant showed more variation, which resulted probably in lowering of the correlation coefficient. When leaves were piled up, the reflectivity at the uppermost surface of the leaves increased particularly at 750 – 900 nm. While at 400 – 700 nm, there was hardly any change in reflectivity and the reflection spectrum of the leaves was almost the same as that of the uppermost leaf. For example, the piling of two leaves with similar leaf thickness in Japanese viburnum, whose reflectivity at 800 nm was 55.3% for each leaf, resulted in the increase to 65.3% for reflectivity at 800 nm. However, the reflectivity at 500 nm of the duplicated leaves was 4.9%, while that of single leaf was 5.0% (the upper leaf) and 5.2% (the lower leaf). The ratio of  $rNI'/rG'$  of the duplicated leaves in Japanese viburnum was 5.79, while that of a single leaf was 6.51 for the upper leaf (chlorophyll content:  $66.6 \mu\text{g}\cdot\text{cm}^{-2}$ ) and 6.14 for the lower leaf (chlorophyll content:  $60.2 \mu\text{g}\cdot\text{cm}^{-2}$ ). In the same way, the ratio of  $rNI'/rR'$  of duplicated leaves was 13.3, while that of a single leaf was 11.1 and 10.6 respectively for the upper and the lower leaf. The chlorophyll content of the duplicated leaves was estimated to be  $79 \mu\text{g}\cdot\text{cm}^{-2}$  by the regression line in Fig. 3. Since the sum of the actual chlorophyll contents of the duplicated leaves was  $127 \mu\text{g}\cdot\text{cm}^{-2}$  ( $=66.6 + 60.2 \mu\text{g}\cdot\text{cm}^{-2}$ ), the estimated value was  $48 \mu\text{g}\cdot\text{cm}^{-2}$  less than the actual one (relative error:  $48/79 \times 100 = 61\%$ ). In the same way, the chlorophyll content was estimated to be  $75 \mu\text{g}\cdot\text{cm}^{-2}$  on the basis of the  $rNI'/rR'$ . This value was  $52 \mu\text{g}\cdot\text{cm}^{-2}$  less than the actual one (relative error:  $52/75 \times 100 = 69\%$ ). In Japanese viburnum where the leaf thickness varied most among the three species tested, the maximum deviation of the leaf thickness was about  $\pm 10\%$  relative to the average value. Therefore, for the use of the  $rNI'/rG'$  – chlorophyll relationship under the assumption that the reflectivity ratio is proportional to the leaf thickness, the maximum error for estimating chlorophyll content would be about  $\pm 6\%$  ( $= \pm 61 \times 0.1\%$ ). In the case of  $rNI'/rR'$ , the maximum error is estimated to be about  $\pm 7\%$  ( $= \pm 69 \times 0.1\%$ ). As shown in Table 1, the standard estimation error for chlorophyll content in Japanese viburnum was the largest. The reason for this result is mainly due to the relatively wide variations of the leaf thickness in Japanese viburnum.

It was reported that the reflection spectrum of a leaf changed with a decrease in leaf water content (6). It is probable, therefore, that the water content is one cause of error for estimating chlorophyll content by the reflectivity ratio. Here, the effects of leaf water content on the reflectivity ratio were examined. The reflectivity at wavelengths greater than 1300 nm increased about 20% for a decrease of 50% in the leaf water content in Japanese viburnum, while the reflectivity at visible wavelengths increased only slightly (ca. 1%), and at the near infrared region the increase was about 4%. Changes in  $rNI'/rG'$  and  $rNI'/rR'$ , however, were only 5% of those respectively obtained under the leaf water content of healthy condition in Japanese viburnum, camphor tree and oleander, even when the leaf water content decreased to 80% of the healthy state, because the increase in spectral reflectivity at the green to near infrared region with decrease in leaf water content was almost the same. Therefore, for the ratios  $rNI'/rG'$  and  $rNI'/rR'$ , the estimated error due to the change in leaf water content will be negligible even in leaves with severe lack of water.

#### *Characteristics of leaf reflection and color development of infrared color photograph*

It was made clear in the previous section that the chlorophyll content of a leaf, which is an indicator of the physiological function of the leaf, can be estimated by reflectivity ratios such as  $rNI'/rR'$  and  $rNI'/rG'$ . Therefore, the estimation of chlorophyll content will be possible by the infrared color photography, if suitable information on leaf

reflection can be extracted from the photograph. Firstly, the color development of an infrared color positive film was studied to find out the most suitable wavelength for analyzing the tone of the color photograph. Secondly, the relation between chlorophyll content of the leaf and the color development of the film, and finally the relation between the reflectivity ratio of the leaf and the bi-band ratio on the color photograph were investigated.

(1) Development of infrared color photograph

According to the spectral sensitivity of the Kodak Infrared Color Film (3), three layers of yellow, magenta and cyan emulsion on the film base are developed by the exposure to light of 500 – 600 nm, 500 – 700 nm and 500 – 900 nm, respectively when the Kodak Wratten gelatine filter (No. 12) is used.

Changes in color development of the film were examined by photographing highly reflective clouds in the sky with the camera on which lens an interference filter was mounted. The abscissa of Fig. 4 shows the wavelength of light exposed to the film and the ordinate in the peak wavelength in the transmission spectrum of the color positive film. The incident light of 500 – 590 nm was developed on the yellow emulsion layer as the color tone of 455 nm (half width: about 100 nm), and that of 600 – 680 nm was developed on the magenta layer as that of wavelength 550 nm (half width: about 60 nm), and light of 690 – 900 nm was developed on the cyan layer as that of wavelength 620 nm. Thus, it was ascertained that the basic wavelengths of color development on the film are 455 nm, 550 nm and 620 nm, and these wavelengths are suitable for analyzing the color tone of the photographs.

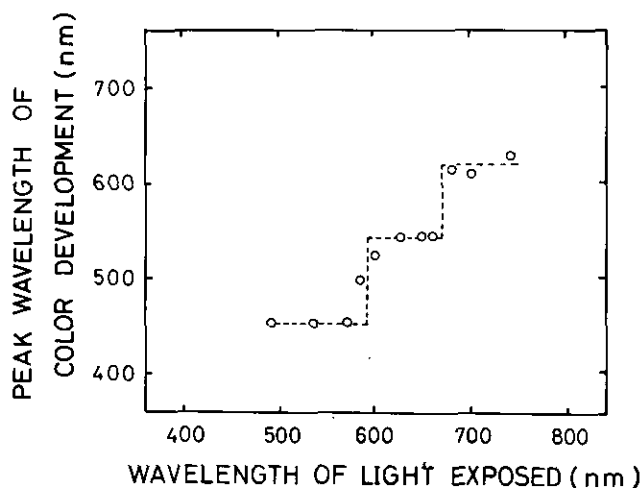

Fig. 4. Relation between wavelength of the light to which the infrared film was exposed and the peak wavelength of the color development. The abscissa shows the wavelength of incident light upon the film, and the ordinate shows the peak wavelength on the transmission spectrum of color development.

(2) Relation between chlorophyll content and color development on the infrared film

Typical examples of the reflection spectrum of a leaf and the transmission spectrum of the leaf image on the color film are shown in Fig. 5. Numerals in the figure show the chlorophyll content in  $\mu\text{g}\cdot\text{cm}^{-2}$ . The data of the upper and lower figures were obtained

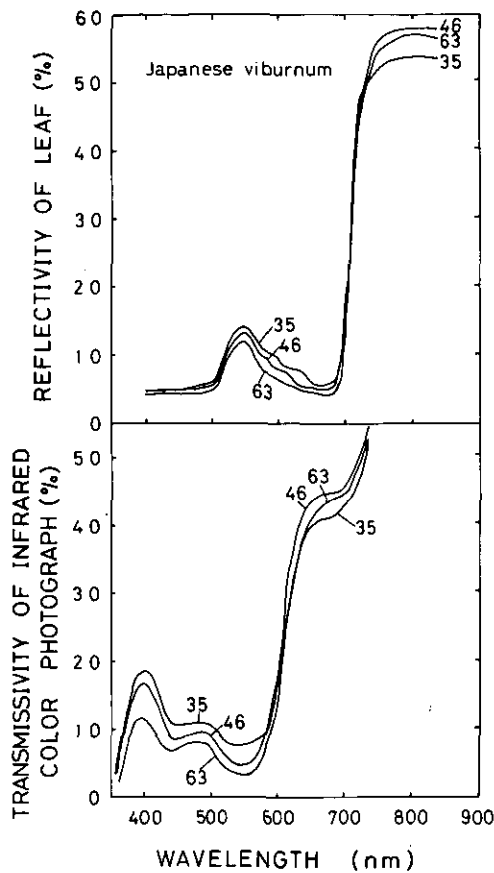

Fig. 5. Spectral characteristics of reflection of leaf and its color development on infrared film. Numerals in the figure show the chlorophyll content in  $\mu\text{g}\cdot\text{cm}^{-2}$ . Data for the upper and lower figures were obtained with the same leaves.

with the same leaves. Three maxima were recognized in the transmission spectrum of the leaf image. From the comparison between the two figures, it can be said that the maximum at the 620 – 670 nm region was caused by the incident light of wavelength around 800 nm, and the other two maxima were produced by interaction between the incident light at 500 – 680 nm and the changes in spectral sensitivity of the yellow and magenta emulsion layers. The transmission spectrum beyond 670 nm may be affected by the transmission characteristics of the film base.

The transmission spectrum of the infrared color positive photograph was dependent on the quantity of light exposed and the quality of the light source. Under the same conditions, for a dark-green colored leaf, which contained much chlorophyll and showed a relatively low reflectivity at the visible region, the development gave a color image of lower transmissivity at all regions. For the yellowish green colored leaf, however, which contained less chlorophyll and showed a relatively large reflectivity at the visible region, the development gave higher transmissivity in the wavelength range 350 – 580 nm. The transmissivity of the film at the 620 nm depended on the chlorophyll content, and was in parallel with the reflectivity of the leaf at 800 nm.

## (3) Bi-band ratio and spectral reflectivity of leaf

As mentioned above, the wavelength of the developed color image on the film was shifted to shorter wavelengths compared to that of the real incident light (Fig. 4), and also the transmission spectrum of the leaf image was remarkably different compared to the reflection spectrum of the leaf. Hence, the relations between the bi-band ratios and the reflectivity ratios were examined.

Interference filters of 461 nm, 535 nm and 624 nm at maximum wavelength (half width: respectively 16 nm, 9 nm and 12 nm) were available for use to analyze the bi-band ratio, although the most suitable wavelengths for analysis were 445 nm, 550 nm and 620 nm, as shown in the previous section. The output voltages of the microdensitometer mounted with the interference filters of 461 nm (B), 535 nm (G) and 624 nm (R) were measured, and various bi-band ratios (R/B, R/G and G/B) were calculated.

The correlation coefficients between the bi-band ratios and reflectivity ratios of leaves in camphor tree and oleander are shown in Table 2. The relations between R/G and

Table 2 Correlation coefficients for the relation between the bi-band ratio and the reflectivity ratio in camphor tree and oleander.

reflectivity ratio	camphor tree (n = 25)			oleander (n = 25)		
	$\frac{rNI'}{rR'}$	$\frac{rNI'}{rG'}$	$\frac{rR'}{rG'}$	$\frac{rNI'}{rR'}$	$\frac{rNI'}{rG'}$	$\frac{rR'}{rG'}$
R/G	0.96	0.95	-0.42	0.88	0.86	-0.12
R/B	0.83	0.91	-0.32	0.82	0.90	0.16
G/B	-0.16	0.00	0.11	0.14	0.32	0.65

B, G and R denote the intensity of light transmission of the infrared color film at 461 nm, 535 nm and 624 nm, respectively. n is the sample size. Other symbols are the same as in Fig. 2.

Measurements in 1979

$rNI'/rR'$  and between R/B and  $rNI'/rG'$  showed high correlation coefficients for both trees (0.96 and 0.91 in camphor tree and 0.88 and 0.90 in oleander, respectively). Also, between R/G and  $rNI'/rG'$  and between R/B and  $rNI'/rR'$ , high correlations were recognized. Even when the light quantity of the exposure varied over the range of 0.75 - 1.5 times that of normal lighting, high correlation coefficients similar to those in Table 2 were obtained between R/B and  $rNI'/rG'$  and between R/G and  $rNI'/rR'$  in camphor tree and oleander.

Therefore, it can be said that the bi-band ratios of R/B and R/G can be utilized as better indices of the chlorophyll content of leaves instead of the reflectivity ratio of  $rNI'/rG'$  and  $rNI'/rR'$ .

*Bi-band ratio and photosynthetic function of leaf*

It was discussed in the previous sections that the estimation of the chlorophyll content in oleander and camphor tree leaves will be possible with high accuracy by using



the bi-band ratio of R/B and R/G. Here, the relation of the bi-band ratio to chlorophyll content which was closely related with the net photosynthetic rate was examined in leaves of camphor tree, oleander and Japanese viburnum. As shown in Fig. 6, the bi-band ratios of R/B and R/G were highly correlated with the chlorophyll content measured in February 1979. Especially in camphor tree, there was a linear relationship to R/G ( $r: 0.96$ ) which varied over a wide range with the change in chlorophyll content. Changes in conditions of lighting and exposure at photographing induced some deviation in the linear regression line between R/G and chlorophyll content, as shown in the left figure in Fig. 6.

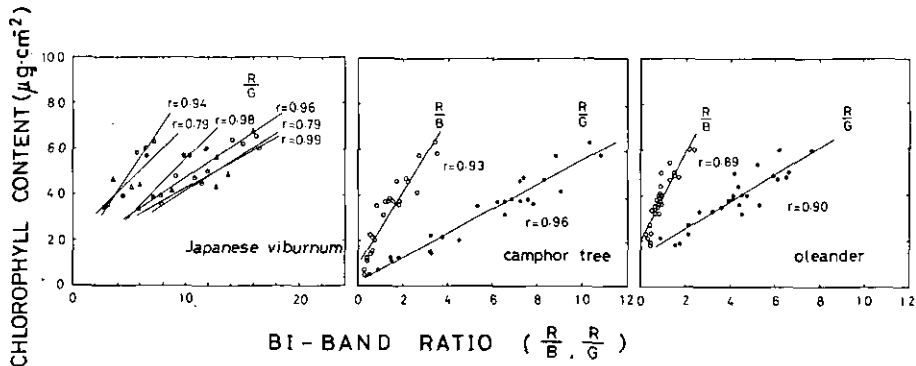

Fig. 6. Relation between the bi-band ratio and the chlorophyll content in Japanese viburnum, camphor tree and oleander. B, G, and R denote the intensity of light transmission of the infrared color positive film at 461 nm, 535 nm and 624 nm respectively. Numerals in the figure show the correlation coefficients ( $r$ ). For Japanese viburnum, the relation was measured under six different photographing conditions.

Typical examples of the relation between the bi-band ratio and the net photosynthetic rate are shown in Fig. 7 in poplar (upper figure) and camphor tree. The R/G ratio showed a linear relationship with the net photosynthetic rate in both plants, while the R/B ratio did not show good linearity in both plants.

Table 3 shows the correlation coefficients between the bi-band ratio and the chlorophyll content and between the bi-band ratio and the net photosynthetic rate, which were obtained using six species of trees in the period 1975 – 1976. The R/G ratio also showed high correlation coefficients between the chlorophyll content and between the net photosynthetic rate ( $r: 0.8 - 0.9$ ) for all plants examined.

Detailed analyses of the correlation coefficient and the error of estimate are shown in Table 4 for camphor tree, oleander and Japanese viburnum in February 1979. Several kinds of bi-band ratios were calculated from the outputs of the spectral transmission of the film at the wavelengths of 417 nm (P), 461 nm (B), 491 nm (BG), 535 nm (G), 583 nm (O) and 624 nm (R) to find out the band most suitable for establishing the relationship between the bi-band ratio and the chlorophyll content. For Japanese viburnum, the coefficient was obtained in five groups of leaves under the same photographing conditions. The range of variation is also indicated in the table. The bi-band ratio, G/B, correlated poorly with the chlorophyll content for all species. The ratios, R/P, R/O, O/B and O/BG

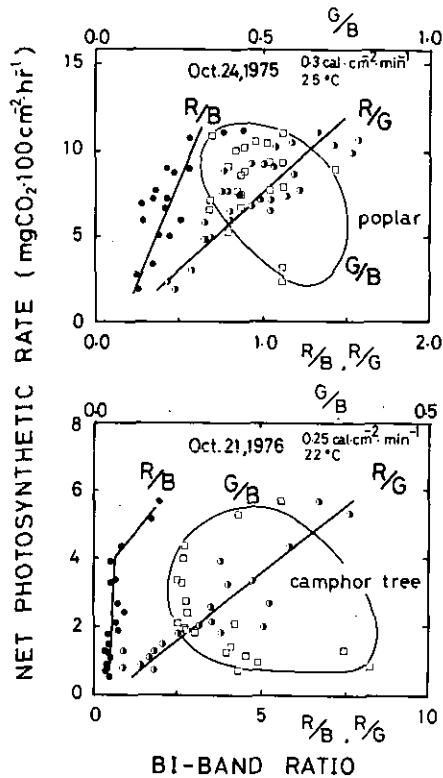

Fig. 7 Relation between the bi-band ratio and the net photosynthetic rate in poplar (upper) and camphor tree. The bi-band ratio is composed of B, G and R which are indicated in Fig. 6.

showed high correlation coefficients ( $r$ : ca. 0.9), but linearity between the ratios and the chlorophyll contents were not good. For R/B and R/G, the correlation coefficient was high for every plant species ( $r$ : 0.89 – 0.96) and linearity was also good. In the case of R/G, the linearity was best among all the bi-band ratios, and ratio changed markedly with change in chlorophyll content. The standard estimation error for evaluating the chlorophyll content with R/G was less than  $5.3 \mu\text{g}\cdot\text{cm}^{-2}$ , which was equivalent to about 10% of the normal content of leaves in the three species tested. When the quantity of exposure to the film decreased, R/G, R/BG and R/B increased even for the same level of chlorophyll content. However, the correlation coefficients were almost the same as those in Table 4. From these facts, it is concluded that R/G is the most suitable bi-band ratio to estimate the chlorophyll content of a leaf. R/BG, which is an intermediate bi-band ratio to R/G and R/B, appeared also to be suitable (see Table 4).

#### Concluding remarks

The bi-band ratio has been used for the remote sensing of plant injury as expressed by the grade of plant activities which are represented by changes of appearance of plants such as leaf color, tree forms and elongation of branches (1, 2, 4).

In the present paper, it was shown that the bi-band ratio R/G correlated highly with

Table 3 Correlation coefficients for the relations between the bi-band ratio and the chlorophyll content and the net photosynthetic rate in several woody plants.

	bi-band ratio	Japanese zelkova 1975 (n=18)	poplar 1975 (n=19)	common catalpa 1975 (n=18)	camphor tree 1975 (n=18)	plane tree 1976 (n=17)	Japanese viburnum 1976 (n=19)
chlorophyll content	R/B	0.87	0.87	—	0.81	0.79	0.92
	R/G	0.86	0.85	—	0.89	0.85	0.81
	G/B	0.80	0.27	—	-0.68	0.56	0.51
net photosynthetic rate	R/B	0.33	0.74	0.84	0.85	—	—
	R/G	0.85	0.86	0.80	0.89	—	—
	G/B	-0.41	-0.68	-0.55	-0.27	—	—

Symbols are the same as in Table 2.  
Measurements in 1975–1976

Table 4 Correlation coefficients for the relation between the bi-band ratio and the chlorophyll content, and the standard estimation error of the chlorophyll content ( $\mu\text{g}\cdot\text{cm}^{-2}$ ) obtained by the bi-band ratio in camphor tree, oleander and Japanese viburnum.

bi-band ratio	camphor tree (n = 25)	oleander (n = 25)	Japanese viburnum (n = 5, 5, 5, 5)
R/P	0.87 (8.4 $\mu\text{g}\cdot\text{cm}^{-2}$ )	0.87 (5.9 $\mu\text{g}\cdot\text{cm}^{-2}$ )	*0.94 [0.88–0.98] (4.3 $\mu\text{g}\cdot\text{cm}^{-2}$ )
R/B	0.93 (6.3 " )	0.89 (5.5 " )	*0.92 [0.79–0.98] (4.5 " )
R/BG	*0.96 (4.5 " )	*0.92 (4.7 " )	*0.96 [0.94–0.99] (3.7 " )
R/G	*0.96 (4.8 " )	*0.90 (5.3 " )	*0.89 [0.79–0.99] (5.0 " )
R/O	0.91 (7.2 " )	0.88 (5.8 " )	0.77 [0.48–0.97] (6.5 " )
G/B	0.00 (— )	0.26 (— )	0.71 [0.32–0.99] (6.8 " )
O/B	0.87 (8.5 " )	0.83 (6.6 " )	—
O/BG	0.93 (6.5 " )	0.87 (6.0 " )	—

P, B, BG, O and R denote the intensity of light transmission of the infrared color positive film at 417 nm, 461 nm, 491 nm, 535 nm, 583 nm and 624 nm respectively. n is the sample size. In Japanese viburnum, data for the correlation coefficient show mean values obtained in 5 groups (n: 5 in each) of leaves. The ranges of the coefficients are shown in [ ] \* shows high linearity.

Measurements in 1979

photosynthetic functions of leaf which were represented by the chlorophyll content and the net photosynthetic rate. This means that the photosynthetic functions of leaf can be estimated by the bi-band ratio R/G on the infrared color photograph.

As shown in Japanese viburnum in Fig. 6, the linear regression equation between the bi-band ratio and the chlorophyll content was dependent on the photographic conditions such as the quantity of light used for film exposure and the quality of lighting. In addition, the equation was also dependent on the developing process, even if photographic conditions remained the same. Therefore, research on the standardization of the bi-band ratio in relation to photosynthetic functions of leaf, such as chlorophyll content, should be performed.

The aim of remote sensing with the bi-band ratio is, generally, to estimate the decrease in photosynthetic functions of a tree as a whole (4, 5, 8, 9) as a result of injury. The crown of trees is composed of a foliage canopy where there are mutual shadings of leaves with various inclinations and orientations. In this case, therefore, the relation between the bi-band ratio and photosynthetic functions of the foliage canopy will be more complicated than that in the case of a single leaf mentioned in the present paper. Such problems should be studied in the future.

The authors thank Mr. Shuji Imai and Mr. Tatsuo Shinohara (Univ. of Osaka Pref.) for their help in the experiments and to Dr. Kiyoshi Sugahara of the National Institute for Environmental Studies for his valuable suggestions concerning measurements of the leaf reflection spectrum. The research was partly supported by "the Special Research Project on Environmental Sciences (1): Basic Study on the Remote Sensing" of the Ministry of Education.

#### References

1. Asia Air Survey Co. Ltd. : *Technical Report No. 8*, 56PP (1972).
2. Kokudo Chiriin, Kensetsu-sho : *Technical Research Report on the Monitoring of Regional Environment by the Activity of Trees and the Transparency of Lakes*. (1979).
3. Nagase Sangyo Co. Ltd. : *Kodak Ektachrome Infrared Film*.
4. Nakajima, I.: Remote sensing of environment and activity of trees. *Agriculture and Horticulture* 48: 195-200 (1973).
5. Oya, F., S. Ochiai, N. Kadoya and M. Maeno: Studies in the evaluation of air pollution from biological index (2). Relation between forest activity and photographic concentration from multi band camera. *J. Jap. Soc. Air Pollut.* 9: 386 (1974).
6. Sinozaki, M., H. Murakami, S. Tatumi and K. Sugahara: Measurement of reflectance spectra of leaf in several plants. *Progress Report in 1976 - 1977, Report of Special Research Project*, the National Institute for Environmental Studies, R - 2 - 78, P. 127 - 134 (1978).
7. Smith, J. H. C. and A. Benitez: Chlorophylls: Analysis in plant materials. *Moderne Methoden der Pflanzenanalyse IV*. 142, Springer, Berlin (1955).
8. Yabuki, K. and M. Aoki: On the ecological survey of plant by infra-red color photograph. *J. Jap. Soc. Air Pollut.* 8: 596 (1973).
9. Yabuki, K., M. Aoki and S. Imai: Ecological survey of plant activity by infra-red color photograph, II. *J. Jap. Soc. Air Pollut.* 10: 320 (1975).

## Measurement of the thermal pattern of plant leaves under fumigation with air pollutant

Kenji Omasa<sup>1</sup>, Fumiaki Abo<sup>1</sup>, Yasushi Hashimoto<sup>2</sup> and Ichiro Aiga<sup>1</sup>

<sup>1</sup> Division of Engineering, The National Institute for Environmental Studies, Yatabe, Ibaraki 305

<sup>2</sup> Faculty of Agriculture, Ehime University, Matsuyama 790

In this paper, we examined some problems of measuring leaf temperature under fumigation with an air pollutant in an environmental control chamber using a scanning type infrared thermal camera. We also measured changes in the leaf temperature pattern during SO<sub>2</sub> fumigation. The results obtained were as follows.

(1) The thermal emissivities of sunflower leaves under various conditions were measured. Though the values obtained were slightly different with individual sample leaves, these values were above 0.95. The emissivity values of leaves exposed two hours to SO<sub>2</sub> were not different from those of healthy leaves.

(2) The effect of the infrared radiation from the ambient environment was corrected by prior measurement. Therefore, in the environmental control chamber, errors in measurement of leaf temperature were within 0.2 °C.

(3) Changes in leaf temperature patterns were measured with this thermal camera during SO<sub>2</sub> fumigation in the chamber. These patterns were compared with the pattern of visible injury occurring on the same leaf. The leaf temperature pattern was similar to the visible injury pattern. Changes in leaf temperature with SO<sub>2</sub> fumigation are indexes of SO<sub>2</sub> sorption rates, thus, the local SO<sub>2</sub> sorption rate at sites on the leaf surface were able to be evaluated from changes in the leaf temperature pattern. As the result, it was recognized that there was a tendency for the visible injury to occur at sites where the amount of SO<sub>2</sub> sorption was over a threshold-value.

**Key words:** Air pollution – Image processing – Thermal pattern – Leaf injury.

Temperature of a plant body is one of the important factors governing physiological reactions in living plants and transportation of substances between plants and the atmosphere. It is known that vegetal temperature i), is susceptible to the influence of various environmental factors, ii), changes remarkably with the physiological condition of each plant, and iii), differs with species of plant. For investigation of the relation between the environment and vegetal reactions, such as the effect of air pollutants on plants, measurement of vegetal temperature is indispensable.

Conventionally, vegetal temperature has been measured by the contact method using thermocouples or thermistors. With the recent development of surface temperature measuring apparatus, non-contact measuring methods using radiation thermometers and scanning infrared cameras have come to attract increasing attention (1, 3, 6, 7). In particular, use of the scanning infrared camera permits obtaining two-dimensional surface

information as to vegetal temperature. Development of this vegetal temperature measuring technique together with image processing has just got under way with many problems remaining unsolved.

In this report, we attempted to examine the problems of applying a scanning infrared camera to the measurement of the leaf temperature of plants exposed to air pollutants. In addition, as an example of the application, we extended an analysis of the relation between  $\text{SO}_2$  sorption rate and visible injury from several sites on a leaf surface (4) to two-dimensional leaf surface all over, through measurement of the leaf temperature pattern during  $\text{SO}_2$  fumigation.

### Measuring method and equipment

#### *Measuring method of leaf temperature by infrared camera*

Assuming that the leaf surface is opaque (2), the intensity  $R(\lambda, T)$  of spectral radiation of infrared rays on the leaf surface is expressed as the sum of thermal radiation from the plant and radiation from the ambient environment (1, 7),

$$R(\lambda, T) = \epsilon(\lambda, T) \cdot W(\lambda, T) + [(1 - \epsilon(\lambda, T)) \cdot E(\lambda, T_s)] \quad (1)$$

where  $\lambda$  is the wavelength;  $\epsilon(\lambda, T)$  is the spectral emissivity of leaf surface at temperature  $T$ ;  $W(\lambda, T)$  is the spectral radiant intensity of black body at temperature  $T$ ; and  $E(\lambda, T_s)$  is the spectral radiant intensity from the ambient environment to leaf surface at temperature,  $T_s$ .

When measuring the radiant intensity  $R(\lambda, T)$  from the leaf surface using an infrared detector having an effective wavelength range  $\lambda_1 \leq \lambda \leq \lambda_2$ , the output voltage  $V_T(T, T_s)$  of the detector is expressed as follows:

$$\begin{aligned} V_T(T, T_s) &= \int_{\lambda_1}^{\lambda_2} f(\lambda) \cdot R(\lambda, T) d\lambda \\ &\simeq \bar{\epsilon}(T) \cdot V_w(T) + [1 - \bar{\epsilon}(T)] \cdot V_E(T_s) \end{aligned} \quad (2)$$

where  $f(\lambda)$  is a coefficient established by considering the radiation-electricity conversion efficiency of an infrared camera detector, amplification factor of internal amplifier, transmissivity and reflection factor of air, lens, filter, etc..

The mean emissivity  $\bar{\epsilon}(T)$ ,  $V_w(T)$  and  $V_E(T)$  are defined as follows:

$$\bar{\epsilon}(T) = \left[ \int_{\lambda_1}^{\lambda_2} \epsilon(\lambda, T) \cdot f(\lambda) \cdot W(\lambda, T) d\lambda \right] / \left[ \int_{\lambda_1}^{\lambda_2} f(\lambda) \cdot W(\lambda, T) d\lambda \right] \quad (3)$$

$$V_w(T) = \int_{\lambda_1}^{\lambda_2} f(\lambda) \cdot W(\lambda, T) d\lambda \quad (4)$$

$$V_E(T) = \int_{\lambda_1}^{\lambda_2} f(\lambda) \cdot E(\lambda, T_s) d\lambda \quad (5)$$

Since the  $V_T(T, T_s)$  is given as output voltage of the detector,  $V_w(T)$  can be obtained if the mean emissivity  $\bar{\epsilon}(T)$  and voltage  $V_E(T)$  corresponding to the radiant intensity from the ambient environment are preliminarily measured and established, as

## Measurement of the thermal pattern of plant leaves

follows:

$$V_w(T) = [V_T(T, T_s) - V_E(T_s)] / \bar{\epsilon}(T) + V_E(T_s) \quad (6)$$

$V_w(T)$  is defined by the output voltage of the detector in measuring the radiation from a black body at a temperature  $T$ . Therefore, if a calibration curve for the black body is obtained, the leaf temperature  $T$  can be derived from  $V_w(T)$ .

### Measuring equipment

The infrared camera used for the experiment was of the object-plane scanning type, having a CdHgTe detector ( $8-13 \mu$ , cooled by liquid nitrogen). Main equipment specifications are given below:

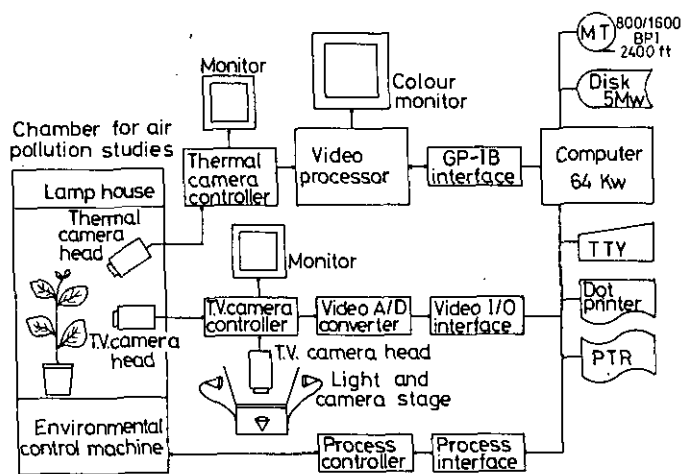

Fig. 1. Block diagram of image processing system.

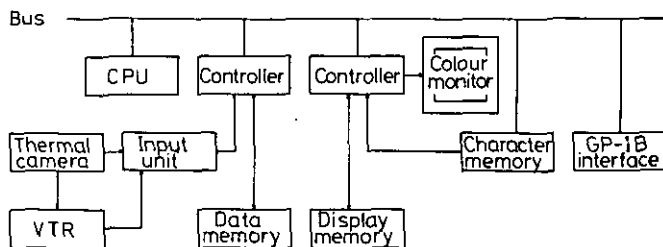

Fig. 2. Block diagram of video processor.

Measurable temperature range	-40 to 2000 °C
Temperature resolving power	0.05 °C for black body at 35 °C
Horizontal image resolving power	300 lines
No. of scanning lines	120 lines (Scan time 1 sec) 240 lines (2 sec) 480 lines (4 sec)
Field of observation	25° H × 20° V
Focus range	20 cm to ∞

Detected signals from the infrared camera are analyzed by an image processing system shown in Fig. 1. In this system, the detected signals are converted into 12-bit digital signals (250 H × 240 V, resolving power 0.05 °C) by an input unit (comprising an A/D converter, filter, etc.) of a video processor (Fig. 2), and then stored in a data memory. The stored signals are displayed on a colour monitor and transmitted to a computer. The computer and video processor are interconnected by a GP-IB bus. Therefore, not only the data are transmitted from the video processor to the computer, but also the results calculated by the computer are transmitted back to the video processor for display on the colour monitor. Having memories comprising magnetic tapes and cartridge magnetic disks, the computer can perform both real-time and batch processing as required. The magnetic tapes permit the employment of a larger computer, too. When combined with VTR or photographic means, this system can be applied also to the analysis of field observation data. The system is also connected to vidicon cameras (0.3 to 2.3 μm) for measuring visible injuries and plant growth. Signals from the camera are converted into 8-bit digital image data (maximum resolving power 1024 H × 1024 V) by a video A/D converter and transmitted to the computer through a video I/O device.

### Measurement of leaf temperature pattern of plants exposed to air pollutants

#### *Effects of ambient environment on measured leaf temperature*

In measuring the leaf temperature with an infrared camera, the mean emissivity  $\bar{\epsilon}(T)$  in Eq. (6) and the voltage  $V_E(T)$  corresponding to the irradiance from the ambient environment must be determined beforehand. Assuming that  $\bar{\epsilon}(T)$ ,  $E(\lambda, T_s)$  and other characteristics of the infrared camera are not dependent upon temperature  $T$ , the mean emissivity  $\bar{\epsilon}(T)$  can be derived from the following equation:

$$\bar{\epsilon} = \{V_T(T_2) - V_T(T_1)\} / \{V_w(T_2) - V_w(T_1)\} \quad (7)$$

The mean emissivity of the sunflower leaf surface was measured, varying  $T_1$  and  $T_2$  between 23°C and 38°C. To keep the ambient environment constant, the measurement was carried out in a space enclosed with black-plained boards held at a constant temperature. The emissivity at the leaf surface proved to be 0.95 or higher, with some leaf-to-leaf variations. This result agreed with the reports of various authors on the emissivities of various plant leaves (1,2,7). A comparison of emissivity between the healthy leaves and those exposed to SO<sub>2</sub> for about 2 hours showed little difference.

In the environmental control chamber for fumigation with air pollutants, the air temperature is controlled within ±0.2°C. However, no consideration is given to the emissivity and temperature of the internal surface of the chamber. For example, the surface of glass below the light source often attains a temperature of as high as about



40 °C. Therefore, the effect of the ambient environment on the measured temperature was examined. The effect of radiation from the ambient environment could be corrected by properly adjusting the voltage  $V_E(T)$  in Eq. (6) in accordance with the radiant intensity from the ambient environment. However the temperature of the internal surface of the chamber varied from place to place, ranging between the air temperature to about 40 °C. With the infrared camera fixed horizontally, the surface of leaf was moved through an angle of 120 degrees (60° to -60°) with respect to the camera face, and temperature measured by the thermocouple and infrared camera were compared. In changing the angle between the leaf surface and camera face, the leaf surface is exposed to radiation from different parts of the chamber interior.  $V_E(T)$  in the experiment was adjusted to the radiant intensity from the ambient environment received by the leaf surface paralleled (0°) to the camera face. The temperature reading difference between the infrared camera and thermocouple proved to be within 0.2 °C, irrespective of the varying angle between the leaf surface and camera face.

#### Measurement of time courses of leaf temperature pattern

Leaf temperature measurements were made to examine the relation between local SO<sub>2</sub> sorption rate and visible injury at several sites on a leaf surface ( $A$ ) using the infrared camera at the plane level. According to Omasa and Abo (4), the relation among the leaf-air temperature difference  $\Delta T$  on the sunflower leaf surface in the controlled environment chamber, transpiration rate  $W$  and SO<sub>2</sub> sorption rate  $Q$  is expressed as follows:

$$\Delta T = - \left\{ L / (8\sigma T_a^3 + 2h_T) \right\} \cdot W + \alpha_p \cdot E_s / (8\sigma T_a^3 + 2h_T) \quad (8)$$

$$Q/W = k \cdot P_{as} / \{ X_s(T_l) - \varphi X_s(T_a) \} \quad (9)$$

where  $T_a$  is air temperature,  $T_l$  is leaf temperature,  $L$  is latent heat by evaporation,  $\sigma$  is Stefan Boltzmann constant,  $h_T$  is coefficient of heat transfer on the leaf surface,  $\alpha_p$  is absorption coefficient of shortwave radiation on leaf surface,  $k$  is  $1.8 \times 10^{-3}$  mmHg.volppm<sup>-1</sup>,  $P_{as}$  is atmospheric SO<sub>2</sub> concentration,  $X_s(T)$  is saturated vapor pressure at  $T$  °C and  $\varphi$  is relative humidity.

From Eqs. (8) and (9), the leaf temperature of plants in the chamber, in which air temperature, humidity, light intensity, wind velocity and other environmental factors are controlled constant, may be regarded as indexes of the transpiration rate and SO<sub>2</sub> sorption rate.

Taking into account the above-described results, time courses of leaf temperature patterns during SO<sub>2</sub> fumigation were measured with the infrared camera. Fig. 3 shows the temperatures of a healthy leaf before SO<sub>2</sub> fumigation, at different sites in the horizontal scanning lines Nos. 1 through 5. The temperatures were nearly uniform except in the vicinity of veins where they tended to be higher. Fig. 4 shows the temperature changes over time in an SO<sub>2</sub> fumigated leaf in the scanning line No. 3. The leaf temperature,  $22 \pm 0.3$  °C in the initial stage of fumigation, rose to  $24 \pm 1.4$  °C in 70 minutes after the start of fumigation. The differences between the leaf temperatures measured by the infrared camera and thermocouple did not exceed 0.3 °C. Fig. 5 shows leaf temperature changes over time at sites a through g. In 70 minutes after the start of fumigation, the temperature rose a maximum of 3.2 °C. and a minimum of 0.7 °C. From the relation between the leaf temperature and SO<sub>2</sub> sorption rate, the SO<sub>2</sub> sorption rate is greatest at

sites where leaf temperatures rise slowly. Visible injuries occurred at a,c,e and g, not at b,d and f. The visible injuries were evaluated (5) 20 hours after the completion of fumigation. No visible injuries occurred in 70 minutes after the start of fumigation during which the leaf temperatures were measured. Fig. 6 shows the relation between the leaf temperatures and visible injuries at sites a through g shown in Fig. 4. The leaf temperatures were values measured at 60 minutes after the start of fumigation. The threshold-value for the occurrence of visible injury was found in the vicinity of 24 °C, at temperatures less than ca. 24 °C visible injuries were present, at temperature greater than

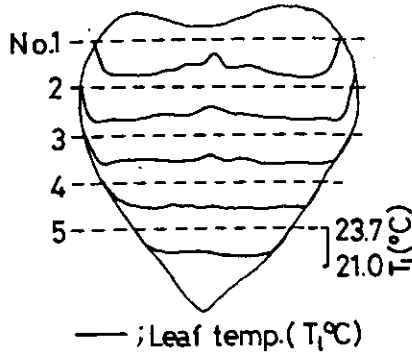

Fig. 3. Leaf temperature at sites of scanning line No. 1–No. 5 before SO<sub>2</sub> fumigation. Air temperature, humidity, wind velocity and light intensity inside the chamber were maintained constant.

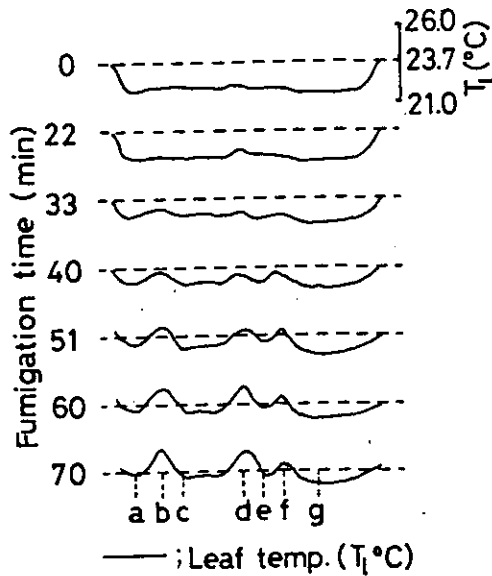

Fig. 4. Changes in leaf temperature during SO<sub>2</sub> fumigation at sites of the scanning line No. 3 in Fig. 3. Visible leaf injury did not occurred during fumigation.

Measurement of the thermal pattern of plant leaves

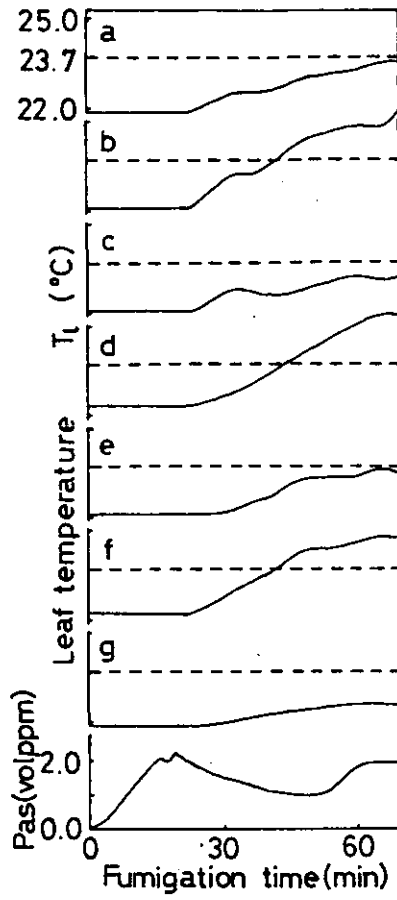

Fig. 5. Continuous leaf temperature changes over time in sites a – g in Fig. 4.

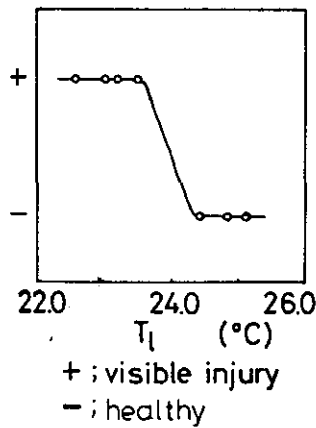

Fig. 6. Relation between leaf temperature 60 minutes after the start of fumigation and local visible leaf injury observed 20 hours later.

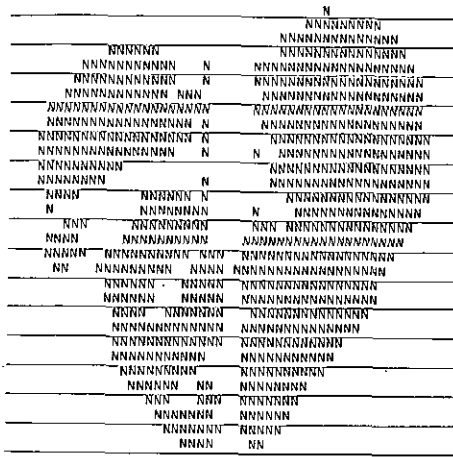

Fig. 7. A two-valued image of leaf temperature 60 minutes after the start of fumigation. The black area plotted 'N' represents site at which the leaf temperature was lower than 23.7 °C, and the white area represents temperatures higher than 23.7 °C.

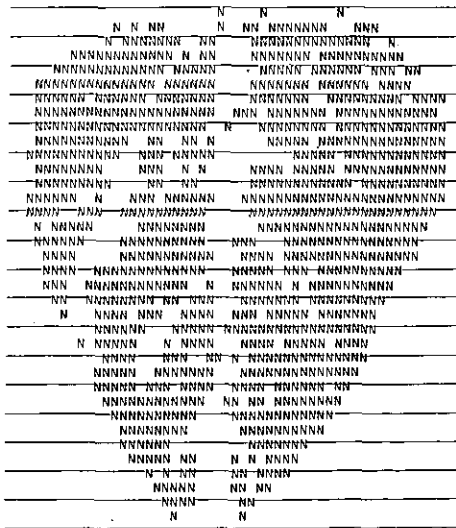

Fig. 8. A pattern of visible leaf injury. The black area plotted 'N' represents the site at which the injury was observed, and the white area represents the healthy site.

ca. 24 °C the leaves appeared healthy. Fig. 7 shows a two-valued image of the leaf temperature in 60 minutes after the start of fumigation, with 23.7 °C as the threshold-value. The black area marked with letter N represents temperatures lower than 23.7 °C, while the white areas represent temperatures higher than 23.7 °C. Fig. 8 shows a pattern of visible injuries on the leaf. The black area represents a portion with visible injuries, while the white area represents a healthy portion. More areas remained healthy in the vicinity of the veins. In the areas remote from the veins, less visible injury occurred in leaf portions with a fast temperature rise.

The foregoing findings, including the fact that the injury pattern was divided into the clearly separated healthy and injured areas (5), suggests that the visible injuries due to SO<sub>2</sub> occur only in sites where the SO<sub>2</sub> sorption rate exceeds a given threshold-value.

### Conclusions

It has been established that the infrared camera is applicable to the measurement of the temperature pattern of plants exposed to air pollutants, without affecting, breaking and contacting the living plants. The vegetal temperature includes information concerning such substance transportation activities as transpiration, sorption of air pollutants, and stomatal aperture. This information can be extracted not at a point but in a plane, by image processing the measurement data from the infrared camera. Based on the findings obtained, we intend to clarify the effects of air pollutants on plants, especially in relation to mass transfer.

We sincerely wish to thank Mr. K. Ioki of Faculty of Agriculture, Ehime University for his cooperation in the processing of part of the experimental data with an analyzer at the university's Laboratory of Agricultural Environmental Engineering. We are also grateful to the Thermoviewer Group of JEOL Ltd., the Computer Group of Mitsubishi Electric Co. and Kyoei Sangyo Co., Ltd., and Mr. I. Nakagawa of Hamamatsu TV Co., Ltd. for their cooperation in the manufacture of the measuring system.

### References

1. Fuchs, M. and C. B. Tanner: Infrared thermometry of vegetation. *Agron. J.* 58: 597-601 (1966).
2. Gates, D. M. and W. Tantraporn: The reflectivity of deciduous trees and herbaceous plants in the infrared to 25 microns. *Science* 115: 613-616 (1952).
3. Hashimoto, Y., K. Ioki, S. Funada, N. Niwa and J. Sugi: Process identification and optimal control of plant growth (VI). Image processing of leaf temperature. *Environ. Control in Biol.* 17: 27-33 (1979).
4. Omasa, K. and F. Abo: Studies of air pollutant sorption by plants. (I) Relation between local SO<sub>2</sub> sorption and acute visible leaf injury. *J. Agr. Meteorol.* 34: 51-58 (1978).
5. Omasa, K., F. Abo, Y. Hashimoto and I. Aiga: Evaluation of air pollution injury to plants by image processing. In *this Report*. p.249-254.
6. Shiraishi, M., Y. Hashimoto and S. Kuraishi: Cyclic variations of stomatal aperture observed under the scanning electron microscope. *Plant & Cell Physiol.* 19: 637-645 (1978).
7. Takiuchi, M. and Y. Hashimoto: Measurement of leaf temperature by means of infrared thermometer in connection with plant physiological information. *Trans. Soc. Instru. Control Engi.* 13: 482-488 (1977).

## Evaluation of air pollution injury to plants by image processing

Kenji Omasa<sup>1</sup>, Fumiaki Abo<sup>1</sup>, Yasushi Hashimoto<sup>2</sup> and Ichiro Aiga<sup>1</sup>

<sup>1</sup>Division of Engineering, The National Institute for Environmental Studies, Yatabe, Ibaraki 305

<sup>2</sup>Faculty of Agriculture, Ehime University, Matsuyama 790

An image processing method was employed to measure the degree and characteristics of visible injuries on plant leaves caused by air pollutants. Healthy leaves and leaves injured by SO<sub>2</sub> and O<sub>3</sub> were photographed through an interference filter. The spectral images obtained were analyzed using two simple characteristic indexes. The results obtained were as follows.

(1) By measuring the surface reflection of injured leaves through an interference filter (central wavelength 671 nm and half-band width 10 nm) under constant lighting condition, it is possible to extract information about visible injuries in relation to chlorophyll destruction.

(2) Using the gray level histogram of the spectral images and the mean value of gray levels, it is possible to quantitatively compare characteristics of SO<sub>2</sub> injury with that of O<sub>3</sub> injury, and then to quantitatively measure the degree of visible leaf injuries.

**Key words:** Air pollution – Image processing – Chlorophyll – Visible leaf injury.

The degree and kind of visible injury to leaves of various plant species have been used as important indexes in evaluating the effect of air pollutants on plants in polluted areas or laboratories (2, 4, 7, 8, 9). The most common method of evaluating leaf injury involves visual observation (3). There are a few reports which relate to quantitative evaluation (2, 3, 5). However, an automatic measuring method which can process a large number of samples is desired. Objective recognition of symptomatic characteristics which corresponds to the visual observations by experts remains to be developed.

Our studies are intended to develop an automatic method of measuring the degree and characteristics of the visible injuries to leaves using image processing of multi-spectral images. In this report, we have sought, as a first step in a series of studies, to analyze reflected spectral images of SO<sub>2</sub> and O<sub>3</sub> injured leaves; and using simple characteristic indexes, to distinguish between these two types injuries.

### Materials and methods

#### Materials

Sunflower (*Helianthus annuus* L. cv. Russian Mammoth) plants were grown in pots filled with a mixture of vermiculite, perlite, peat moss and fine gravel at a ratio of 2:2:1:1 in Phytotron (daytime: 25°C; nighttime: 20°C; 70%RH; natural light). Plants used for the

experiments were 6 weeks old (leaf area per plant: 1500–2500 cm<sup>2</sup>; number of leaves: 15–25).

#### *Gas fumigation*

Test plants were exposed to 1.5 volppm SO<sub>2</sub> for 3 hours or 0.8 volppm O<sub>3</sub> for 2 hours in an environmental chamber (1). Following exposure, the plants were grown in a Phytotron for 3 days until no further the fading of vegetal pigments at the injured parts occurred. Environmental conditions inside the chamber were: temperature 25 ± 0.5°C; humidity 60 ± 3%RH; average wind velocity 0.22 m·s<sup>-1</sup>; and light intensity 40 ± 5 klux at 1.3 m below light source. Control accuracies of SO<sub>2</sub> and O<sub>3</sub> concentrations were both within 0.5% of the set values.

#### *Image processing*

Healthy and injured leaves were photographed through an interference filter under constant lighting condition. The spectral images (negative film, 24 × 36 mm<sup>2</sup>) obtained were analyzed by an image processor. The leaves were photographed immediately after they were cut off to minimize the effect of wilting. In the image processor, one frame of the negative film was converted into digital signals with the number of picture elements 256 × 240 and quantization levels (gray level) 256.

#### *Determination of chlorophyll*

A piece of leaf (20 × 20 mm<sup>2</sup>) was cut off, photographed immediately, and then homogenized in 80% acetone. After centrifuging, the absorption spectra of the supernatant solution were measured by spectrophotometer. Chlorophyll content was determined using absorption coefficient of Mackinney (6).

#### **Selection of the wavelength band for extraction of information about visible injuries**

It is known that visible injuries are observed through the fading of vegetal pigments. Chlorophyll is one of the major components of the fading vegetal pigments (3, 5). Therefore, we attempted to extract information about visible injuries using the absorption band of chlorophyll.

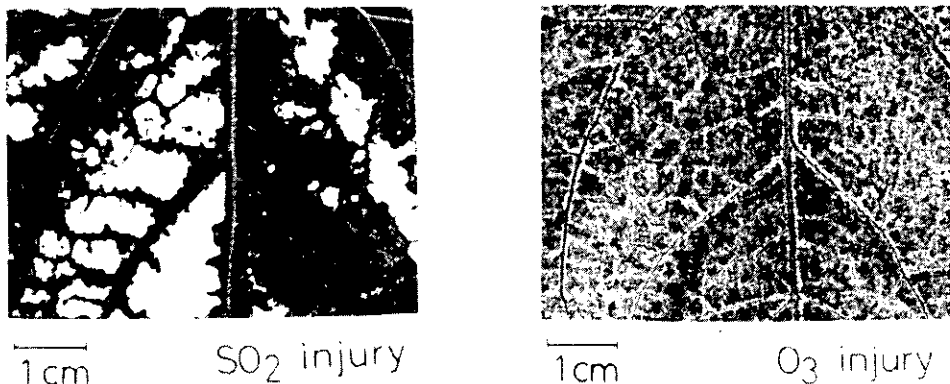

Fig. 1. Examples of spectral image of SO<sub>2</sub> and O<sub>3</sub> injured leaf. (Interference filter:  $\lambda_{max}=671nm$ ,  $\lambda_{1/2}=10nm$ )

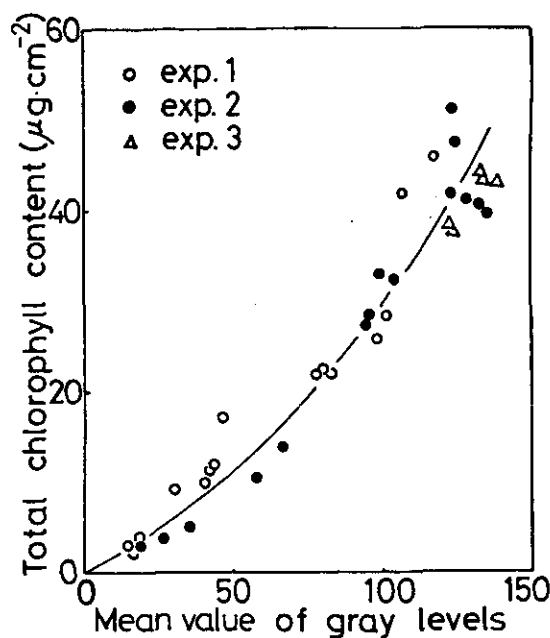

Fig. 2. Relation between mean value of gray levels of spectral image (negative film) and total chlorophyll content.

Fig. 1 shows typical images of  $\text{SO}_2$  and  $\text{O}_3$  injured leaves which were photographed through an interference filter with a central wavelength of 671 nm and a half-band width of 10 nm. Note that healthy parts of the leaves in the photographs appear dark because of large absorption of light by chlorophyll, while parts of visible injuries appear white because of small absorption of light and large reflection. It was observed that comparatively broad visible injuries occurred on the  $\text{SO}_2$  fumigated leaves, whereas thin visible injuries occurred around veins of the  $\text{O}_3$  fumigated leaves.

The  $\text{O}_3$  fumigated leaves were used to determine the quantitative relation between the visible injuries photographed by this method and the chlorophyll content. The relation between the mean value of gray levels of the spectral images (negative film) of the photographed leaves ( $20 \times 20 \text{ mm}^2$ ) and the total chlorophyll content is shown in Fig. 2. The sampling point interval in the image processing was approximately 0.4 mm on the leaf surface. From Fig. 2, a positive correlation between the mean value of gray levels and the total chlorophyll content of injured leaves was recognized. Since the mean value of gray levels is obtained through analysis of the negative film, there is a tendency for the value to be smaller with a larger reflection from the leaf surface. Although the experiment was repeated 3 times, the difference in the results cannot be regarded as significant. From the results, it was found that information about visible injuries relating to chlorophyll destruction was extractable by measuring the reflection of light from the leaf surface through the chlorophyll absorption band filter.



### Comparison of visible injuries occurring on SO<sub>2</sub> and O<sub>3</sub> fumigated plants

It is presumed that there are characteristic indexes which indicate the nature of visible injuries. In this report, the gray level histogram and the mean value of gray levels were adopted and examined, as principal characteristic indexes. Fig. 3 gives representative examples of the gray level histogram in the negative films of healthy, SO<sub>2</sub> and O<sub>3</sub> injured leaves photographed through a 671 nm interference filter. In order to obtain normalized results, the size of the sample leaves was kept at 90 × 75 mm<sup>2</sup> and the sampling point interval was about 0.8 mm. In Fig. 3, the gray level histogram of healthy and O<sub>3</sub> injured leaves shows a normal type distribution, however the O<sub>3</sub> injured leaf had a smaller gray level than the healthy leaf. On the other hand, the SO<sub>2</sub> injured leaf had two maximum values; the gray level in one maximum was close to that of the healthy leaf, the gray level in the other maximum was close to that of a completely injured leaf. This means that visible injury occurs relatively homogeneously over the entire leaf surface in the case of the O<sub>3</sub> injured leaf. Whereas, the healthy section and the injured section are completely separated in the case of the SO<sub>2</sub> injured leaf.

Fig. 4 shows the mean value of gray levels and the gray level of maximum value of the histogram in different leaf positions of one plant. Visible injuries were greater on low leaf positions in both SO<sub>2</sub> and O<sub>3</sub> fumigated leaves. The mean value of gray levels and the gray level of maximum values in healthy or O<sub>3</sub> fumigated leaves were approximately equal regardless of leaf position or the degree of injury. On the other hand, in the case of SO<sub>2</sub> fumigated leaves, the injured leaves had two maximum values as above (Fig. 3). Leaves with no injury had one maximum value with their mean values of gray levels being roughly equal to that of healthy leaves.

The above results show the possibility of comparing quantitatively differences in visible injuries between SO<sub>2</sub> fumigated leaves and O<sub>3</sub> fumigated leaves using the gray level histogram and the mean value of gray levels. These characteristic indexes may be used for automatic recognition of symptomatic characteristics of the visible leaf injuries. Also, they may be used for automatic measurement of the degree of visible injuries because the

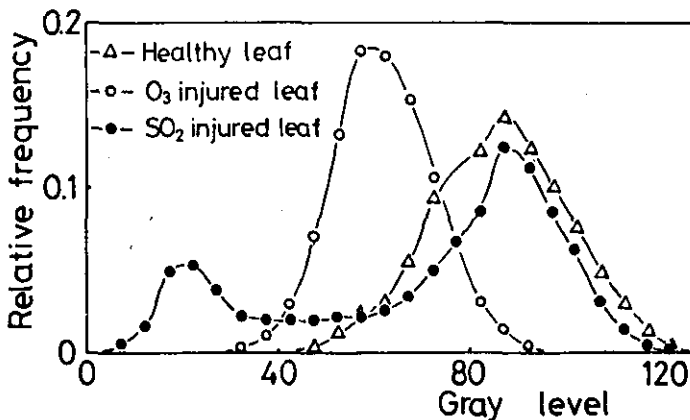

Fig. 3. Examples of gray level histogram in the image of healthy or injured leaves.

## Evaluation of pollution injury by image processing

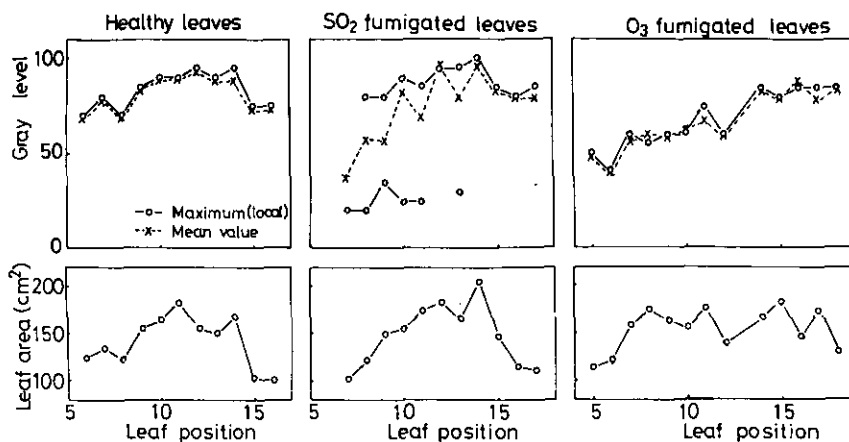

Fig. 4. Mean value of gray levels and gray level of maximum value of the histogram in different leaf positions.

gray level histogram is related to area of the injured parts and the mean value of the gray levels is related to chlorophyll content.

### Conclusions

In this report, a method using the image processing for evaluation of visible injuries was examined. First, a wavelength band for extracting informations about the visible injuries was selected, and it was found that the information relating to chlorophyll destruction was obtained by measuring reflection from the leaf surface through an interference filter in the chlorophyll absorption band (central wavelength 671 nm and half-band width 10 nm). Next, reflected spectral images of SO<sub>2</sub> and O<sub>3</sub> injured leaves photographed through the filter were analyzed. It was shown that symptomatic characteristics of SO<sub>2</sub> injured leaves could be quantitatively compared with that for O<sub>3</sub> injured leaves by using simple characteristic indexes, such as the gray level histogram and the mean value of gray levels. These characteristic indexes could be used for automatic recognition of symptomatic characteristics of the visible injuries. It must be added, however, that there are types of characteristic indexes of injuries other than those described here. We will intend to be developed an automatic measurement method of visible injuries after a detailed studies of such characteristic indexes.

We sincerely wish to thank Mr. K. Shimazaki of the Division of Environmental Biology of our Institute for his valuable advice, and Mr. K. Ioki and Mr. S. Kaneko, Faculty of Agriculture of Ehime University for their cooperations, and members of the Division of Engineering who took part in maintenance of the equipment and cultivation of plants used in the experiments.

### References

1. Aiga, I., K. Omasa and Y. Kobayashi: The environmental control system for plant experiment in National Institute for Environmental Studies. In *Examples of the newest air conditioning system*.

- p. 315-363. Keiei Kaihatsu Center, Osaka, 1980.
2. Bressan, R. A., L. G. Wilson and P. Filner: Mechanisms of resistance to sulfur dioxide in the cucurbitaceae. *Plant Physiol.* 61: 761-767 (1978).
  3. Chester, K. S.: How sick is the plant? In *Plant pathology, Vol. 1, The diseased plant*, Edited by J. G. Horsfall and A. E. Dimond, p.100-142. Academic Press, New York, 1959.
  4. Jacobson, J. S. and A. C. Hill: *Recognition of air pollution injury to vegetation: A pictorial atlas*. Air Pollution Control Association, Pennsylvania, 1970.
  5. Knudson, L. L., T. W. Tibbitts and G. E. Edwards: Measurement of ozone injury by determination of leaf chlorophyll concentration. *Plant Physiol.* 60: 606-608 (1977).
  6. Mackinney, G.: Absorption of light by chlorophyll solutions. *J. Biol. Chem.* 140: 315-322 (1941).
  7. Mudd, J. B. and T. T. Kozlowski: *Responses of plants to air pollution*. Academic Press, New York, 1975.
  8. Japanese Association of Public Health: *A report of investigation of effects of air pollutants on plants*. p.115-129. Japanese Association of Public Health, 1977.
  9. Japan Society of Air Pollution: *Photographical collection of air pollution injuries to vegetation*. Japanese Association of Public Health, 1973.

## Selected rice (*Oryza sativa* L.) strains as an indicator plant for air pollution

Yasumi Fujinuma and Ichiro Aiga

Division of Engineering, The National Institute for Environmental Studies, Yatabe, Ibaraki 305

The sensitivity of selected rice strains to typical air pollutants, i.e.  $O_3$ ,  $SO_2$  or  $NO_2$ , was examined using 450 local rice varieties (*Oryza sativa* L.) in Japan. Some varieties were sensitive to  $SO_2$  showing visible foliar injury caused by the exposure to 2.0 ppm  $SO_2$  for 4 hrs. but resistant to  $O_3$  with no symptoms even when the exposure to 0.5 ppm  $O_3$  was prolonged for 4 hrs., while others had reverse responses to  $SO_2$  or  $O_3$ . Among the varieties, LO 182 was the most sensitive to  $SO_2$ . Offsprings from LO 182 were produced using the hereditary method, and rice plants more sensitive to  $SO_2$  than LO 182 were found. The characteristics of these rice varieties and those offsprings mutated from LO strains will be described. Furthermore, the possibility of utilization of  $SO_2$ -sensitive mutants as indicator plants will be discussed.

**Key words:** Air pollution – Indicator plant – Gas sensitive mutant – Rice plant – Sulfur dioxide.

Recently, there has been increased interest in the utility of plants for monitoring and assessing air pollution. Some investigators are trying to evaluate a number of ecological and physiological phenomena to establish their utility for early diagnosis of air pollution injury (6, 7, 10). In Japan, morning glory has been utilized for monitoring oxidants in rural and industrialized areas (4).

In our research projects concerned with the effects of air pollution on plants, we are attempting to obtain indicator plants from rice varieties to assess the concentrations and types of air pollutants. Rice plants are somewhat more resistant to air pollutants than other herbaceous (such that morning glory) or crop plants (2, 3), and so it seems to be unfavorable to use rice plants as an indicator species. However, Omura et al. (9) have previously found some sensitive varieties by exposing  $SO_2$  to some hundreds of local rice varieties in Japan. Furthermore, because it is easy to obtain various rice varieties, the possibility of utilizing rice plant varieties as air pollution indicators is being investigated. Concerning this research theme, we are trying to find much more sensitive rice plants from the offsprings produced by the hereditary procedure.

In the present report, we exposed some cultivated rice varieties to  $O_3$ ,  $SO_2$  or  $NO_2$  to determine the experimental conditions for selecting sensitive varieties. After determining the experimental conditions, more than 400 varieties were exposed individually to air pollutants. From this result, we found that some varieties are specifically sensitive to  $SO_2$  or  $O_3$ . Then, some of these sensitive varieties were treated

with mutagenic chemicals to induce mutations. We will discuss the sensitivity of the offspring with respect to the air pollutants.

### Materials and methods

#### *Plant materials*

Seeds of 1300 rice varieties (1), collected as LO strains in Kyushu University, were kindly presented by Professor Omura. According to the result of Omura et al. (9), we selected 400 varieties from 1300 varieties. Some rice varieties were treated with a mutagenic chemicals, n-methyl-n-nitrosourea (MNU), by Dr. Satoh, Laboratory of Plant Breeding, Kyushu University. The seeds that were obtained from the panicles treated with MNU, were defined as  $M_1$  seeds.

#### *Culture method*

After sterilization, seeds were incubated on moistened filter paper for 48 hrs in the dark. Germinating seeds were planted, radicle down, in a mixture of granular compost (prepared especially for rice seedlings): vermiculite (1:1, v/v) in plastic containers. The seedlings were grown in a phytotron greenhouse at 27°C, 70% R.H. for 3 weeks. Nutrient solution (0.1 % Hyponex) was supplied twice per 3 weeks.

#### *Exposure to air pollutants*

Seedlings were watered and transferred from the phytotron greenhouse into the artificially lit fumigation cabinet in the phytotron of the National Institute for Environmental Studies. Seedlings were pre-conditioned in the cabinet for 2 hrs before exposure to  $O_3$ ,  $SO_2$  or  $NO_2$ . The exposure to the respective air pollutants was performed at 27°C, 70 % R.H., 30 Klux and a wind velocity of below 30  $cm \cdot sec^{-1}$ .

#### *Estimation of visible injury*

Visible injury caused by  $O_3$ ,  $SO_2$  or  $NO_2$  varied in the appearance of symptoms and also with respect to the degree and area of necrosis. Seedlings were maintained in light conditions in the cabinet for 24 hrs and the degree of injury was determined in adopting

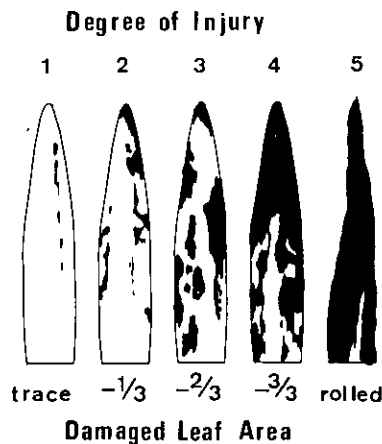

Fig. 1. Index as degrees of visible injury of rice seedlings based on damaged leaf area with air pollutants.

five grades of necrosis on a leaf area basis (Fig. 1). The values expressing the degree of visible injury represented mean value of at least ten seedlings.

### Results and discussion

#### *Standardization of selecting sensitive rice varieties*

To establish the method for selecting sensitive varieties of rice plants to air pollutants, two varieties, Kinmaze and Nihonbare, were grown in the phytotron greenhouse at 27°C, 70% R.H. for 3 weeks. These two varieties are slightly resistant to air pollutants compared with other varieties (8). However, we used these two varieties as unity to compare the sensitivity of other rice varieties to air pollutants.

When these two varieties were exposed to 2.0 ppm O<sub>3</sub> for various exposure periods, the most injurious effects were always noted on the 4th leaves in both varieties irrespective of the exposure period (Fig. 2). The foliar responses of these varieties to SO<sub>2</sub> or NO<sub>2</sub> were also marked on the 4th leaves. Based on these findings, the sensitivities of rice varieties to air pollutants were graded by determining the degree of the necrosis which appeared on the 4th and 5th leaves of 3-week old seedlings.

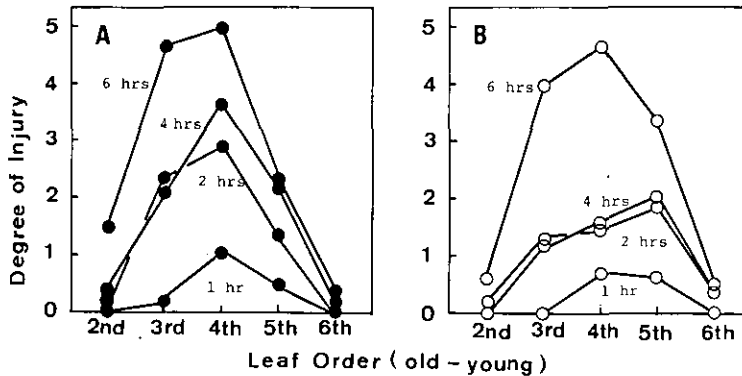

Fig. 2. Relation between visible injury and leaf age. Nihonbare (A), Kinmaze (B). Rice seedlings were exposed with 0.2 ppm O<sub>3</sub> under light conditions. Time in figure indicates exposure period.

The effects of different concentrations of SO<sub>2</sub>, NO<sub>2</sub> or O<sub>3</sub> at different exposure periods are presented in Fig. 3-A & B for foliar injury on Kinmaze and Nihonbare. These two varieties responded similarly to SO<sub>2</sub>, NO<sub>2</sub> or O<sub>3</sub> regardless of the concentrations and exposure periods of these air pollutants.

The relation between the dose (ppm·hr) of SO<sub>2</sub>, NO<sub>2</sub> or O<sub>3</sub> and the degree of foliar injury is illustrated on a logarithmic scale in Fig. 4 using the data presented in Fig. 3. Doses required to induce foliar necrosis on these rice varieties were approximately 1.5–2.0 ppm·hr SO<sub>2</sub>, 0.2 ppm·hr O<sub>3</sub> and 15–20 ppm·hr NO<sub>2</sub>. Thus we assumed that these three air pollutants can be ranked in the following order according to the degree of foliar necrosis: O<sub>3</sub> > SO<sub>2</sub> > NO<sub>2</sub>. The ranking of toxicity of these air pollutants coincides with the result observed by Bennett & Hill (5) in the inhibition of photosynthesis of alfalfa. From the dose-response relations, we exposed seedlings to 0.2 ppm O<sub>3</sub> for 4 hrs, 2.0 ppm SO<sub>2</sub> for 6 hrs or 8.0 ppm NO<sub>2</sub> for 6 hrs to determine the order of sensitivity of rice varieties to these air pollutants.

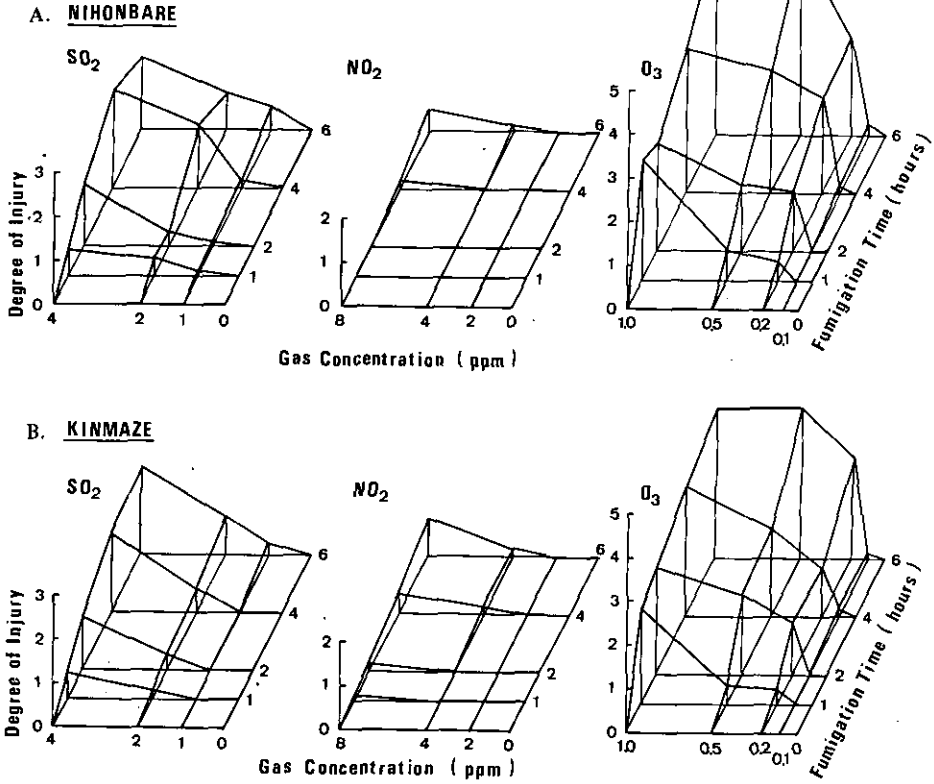

Fig. 3. Effects of gas concentration and exposure period on visible injury of rice seedlings. Nihonbare (A), Kinmaze (B).

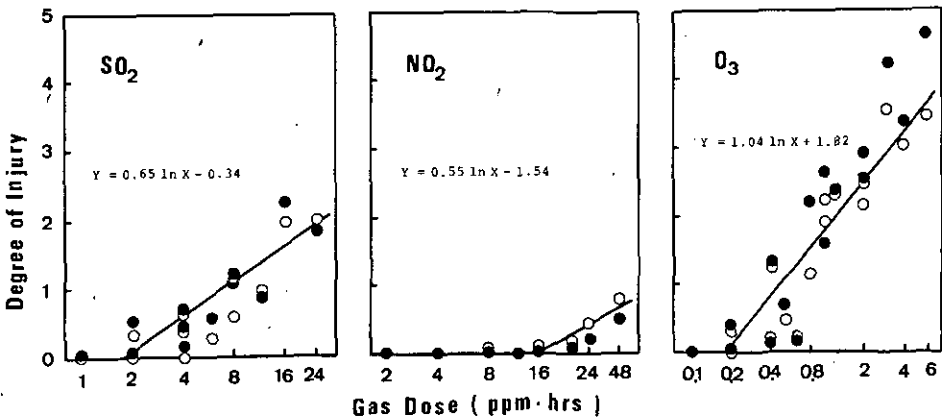

Fig. 4. Effects of gas dose (ppm·hr) on visible injury of rice seedlings. Nihonbare (●), Kinmaze (○). Figures were designed from Fig. 3.

Rice strains as indicator plant for air pollution

*Sensitive Japanese local rice varieties (LO strains)*

It is a rare situation when only one air pollutant is present in the atmosphere. Many sources in urban and industrial areas discharge two or more major pollutants into the atmosphere. The need for identifying plant varieties which specifically respond to respective air pollutants is therefore apparent.

We selected 400 local rice varieties in Japan from LO strains and the sensitivities of these varieties to O<sub>3</sub>, SO<sub>2</sub> or NO<sub>2</sub> were examined (Table 1). The local distribution of rice varieties was ranked by the degree of foliar injury induced by gas exposure. Omura et al. (9) described in their preliminary report that the varieties originated in the southern regions of Japan were more resistant to SO<sub>2</sub> than those in the northern regions. We could also find regional differences in resistance to SO<sub>2</sub>. However, we could not find this with regard to O<sub>3</sub>. Furthermore, we could not find any NO<sub>2</sub>-sensitive varieties.

Table 1 *The local distribution of rice varieties in Japan (LO strains) classified according to degrees of visible injury with fumigation of respective pollutants; SO<sub>2</sub>, O<sub>3</sub> and NO<sub>2</sub>*

Prefecture	Degree of Visible Injury													
	SO <sub>2</sub>					O <sub>3</sub>					NO <sub>2</sub>			
	-	+	++	##	###	-	+	++	##	###	-	+	++	##
Aomori			1							1				1
Akita	3	17	12	1	1	1	11	13	8					33
Fukushima	3	4	3	1		1	2	3						10
Nagano		3	4			1	2	3						7
Yamanashi			1						1					1
Niigata	2	4	2	1			2	3						8
Tōyama	2	5	1			1	4	3						9
Ishikawa	4	10	2			1	1	7	5					16
Fukui		6	4			4	5	2						10
Shiga	8	8	1	2		1	8	9	1					23
Mie	8	8	4				3	9	9	1				23 1
Nara	1	2						1	2	1				4
Wakayama	1	9	5	1				3	11	4				14 4
Tottori	1	6	3					5	5	1				9 2
Shimane	7	13	15				7	22	3					28 7
Hiroshima	3	10	4				2	10	4					16 1
Tokushima	5	9	6				5	10	4	1				17 2
Kagawa	-							3						1
Kōchi		4	4					7	3					8 1
Fukuoka	3	3	5				1	13						6
Nagasaki		10	3					5	8					10 2
Oita		3	3			1	1	2	1					12
Kumamoto			2					1						3 1
Miyazaki	1	2	2					1	3	2				6
Kagoshima	2	2	2				1	2	4					6

Each value indicates numbers of varieties.

The result presented in Table 1 is expressed as the relation between the degree of leaf necrosis caused by SO<sub>2</sub>-exposure and that caused by O<sub>3</sub>-exposure (Table 2). Some varie-



ties responded similarly to both SO<sub>2</sub> and O<sub>3</sub>, while for others the response was different with regard to these air pollutants. Those varieties which respond similarly to SO<sub>2</sub> and O<sub>3</sub> accounted for 72% of the varieties (LO strains) tested. However, the most notable finding is that one strain (we could detect only one strain from 400 strains), which could tolerate SO<sub>2</sub> (no visible injury), showed the highest degree of visible injury caused by O<sub>3</sub>. This interesting finding suggests that we may be able to estimate the concentrations of individual pollutants in complex polluted air environments using such a strain.

Table 2 *The variations of SO<sub>2</sub> and O<sub>3</sub> sensitivity in local rice varieties in Japan (LO strains)*

O <sub>3</sub>	Degree of Visible Injury				
	SO <sub>2</sub>				
	-	+	++	##	###
-	4	5	4		
+	10	24	15		
++	30	57	36	4	1
##	6	35	22		
###	1	3	5		

Each value indicates numbers of varieties.

#### *SO<sub>2</sub>-sensitive mutant*

We selected SO<sub>2</sub> sensitive (LO 138, 152, 182) and resistant (LO 412, 817) strains from the LO strains and treated them with MNU to obtain the mutations for SO<sub>2</sub> sensitivity. LOM<sub>2</sub> seedlings were grown for 3 weeks and exposed to 0.5 and 2.0 ppm SO<sub>2</sub> for 4 hrs. The wide variations for SO<sub>2</sub> sensitivity were observed in all of LOM<sub>2</sub> populations (Table 3). In LOM<sub>2</sub>-3, of which original strains LO 182 is known as the most

Table 3 *Changes in SO<sub>2</sub> sensitivity of M<sub>2</sub> Seedlings of LO lines treated with MNU*

Mutants LOM <sub>2</sub> line	Original variety		Degree of injury with SO <sub>2</sub>	
	LO NO.	SO <sub>2</sub> response	0.5ppm 4hrs	2.0ppm 4hrs
LOM <sub>2</sub> -1	138	sensitive	0-2 ( 0 )	0-3 (0-1)
LOM <sub>2</sub> -2	152	sensitive	0-3 (0-1)	0-4 (0-2)
LOM <sub>2</sub> -3	182	sensitive	0-4 (0-2)	0-5 (0-4)
LOM <sub>2</sub> -4	412	resistant	0-2 (0-1)	1-3 (0-2)
LOM <sub>2</sub> -5	867	resistant	0-2 (0-1)	1-2 (0-2)
NIHONBARE, KINMAZE			0-1	0-2

Values in parentheses indicate the variations in the original varieties.

sensitive to  $\text{SO}_2$  in LO strains, seedlings more  $\text{SO}_2$ -sensitive than LO 182 seedlings were obtained. When  $\text{LOM}_2\text{-3}$  was exposed to 0.5 ppm  $\text{SO}_2$  for 4 hrs, 15.7% of  $\text{M}_2$  seedlings were more sensitive to  $\text{SO}_2$  than LO 182 (Fig. 5). These results may suggest that there is a possibility to obtain  $\text{SO}_2$ -supersensitive rice varieties by mutations.

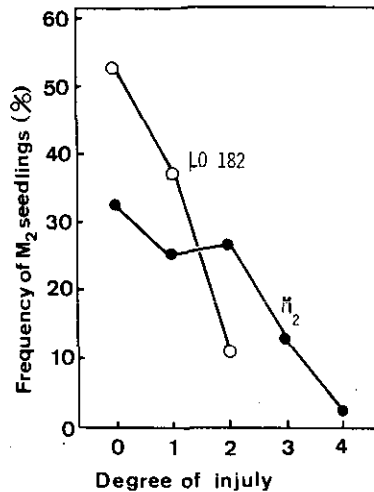

Fig. 5. Distribution of  $\text{M}_2$  seedlings for  $\text{SO}_2$  sensitivity in  $\text{LOM}_2\text{-3}$  population exposed to 0.5 ppm  $\text{SO}_2$  for 4 hrs.

$\text{CM}_2$  seedlings of Kinmaze were exposed to  $\text{SO}_2$ . Although Kinmaze is resistant to  $\text{SO}_2$ ,  $\text{SO}_2$ -sensitive seedlings were segregated in some of  $\text{CM}_2$  lines. In order to examine the relation between  $\text{SO}_2$  and  $\text{O}_3$  sensitivities, we exposed  $\text{CM}_3$  seedlings derived from  $\text{SO}_2$ -sensitive  $\text{CM}_2$  to  $\text{SO}_2$  and  $\text{O}_3$ . Although Kinmaze is slightly resistant to  $\text{O}_3$ , the  $\text{O}_3$ -sensitivity of  $\text{CM}_3$  seedlings varied from resistant to sensitive. The most resistant and sensitive lines in average are shown in Table 4. This result shows that the mutation sensitive to  $\text{O}_3$  as well as  $\text{SO}_2$  is inducible.

Table 4 The variations of response to  $\text{O}_3$  in  $\text{SO}_2$  sensitive mutant lines ( $\text{CM}_3$ ) generated from Kinmaze

KINMAZE mutants ( $\text{CM}_3$ )		Degree of Visible Injury	
$\text{SO}_2$ sensitive	$\text{O}_3$ response	$\text{SO}_2$ 2.0ppm 4hrs.	$\text{O}_3$ 0.5ppm 4hrs.
$\text{CM}_3$ 1-3-45	sensitive	4.7	2.5
$\text{CM}_3$ 1-4-2	sensitive	4.8	2.4
$\text{CM}_3$ 2-1-7	sensitive	4.3	2.7
$\text{CM}_3$ 2-4a-28	sensitive	2.6	3.0
$\text{CM}_3$ 2-4a-40	sensitive	3.7	2.6
$\text{CM}_3$ 1-1-1	resistant	2.2	.7
$\text{CM}_3$ 1-2-22	resistant	2.2	.7
$\text{CM}_3$ 1-3-20	resistant	3.2	.9
KINMAZE (original variety)		.9	1.1

We wish to express our sincere thanks to Professor T. Omura and Dr. H. Satoh, Kyushu University, for providing the rice seeds used in this experiment and for treating rice plants with mutagenic chemicals. We are also grateful to Dr. A. Furukawa, Division of Environmental Biology, the NIES, for his critical reading of the manuscript.

#### References

1. Agri., Forestry & Fishery Technology Council ed. Characteristics of local rice varieties in Japan. (in Japanese), 1970.
2. Agri., Forestry & Fishery Technology Council ed. Studies for method of measurement to damages of crops with air pollution. *Report of Research*; 63, (in Japanese) 1973.
3. Agri., Forestry & Fishery Technology Council ed. Studies for circulation of polluted substances and biological indicators on agro, forest & aquatic ecosystems, *Report of Research*; 102, (in Japanese) 1977.
4. All Japan photochemical smog investigation committee. *The report of investigations in photochemical smog with morning glory*, Yomiuri Newspaper Pub. (in Japanese) 1977.
5. Bennett, J.H. and A.C. Hill: Inhibition of apparent photosynthesis by air pollutants. *J. Envir. Qual.* 2: 526-530 (1973).
6. Hawsworth, D.L. and F. Rose: Qualitative scale for estimating sulphur dioxide air pollution in England and Wales using epiphytic lichens. *Nature* 227: 145-148 (1970).
7. Jacobson, J.S. and W.A. Feder: A regional network for environmental monitoring: Atmospheric oxidant concentrations and foliar injury to tobacco indicator plants in the Eastern United States: *Univ. Massachusetts Bulletin*; No. 64 (1974).
8. Matsuoka, Y.: Experimental studies of sulfur dioxide injury on rice plant and its mechanism. *Special bulletin of the Chiba-ken Agri. Exper. Station.* No. 7. (in Japanese) 1978.
9. Omura, T., H. Satoh and K. Sugahara: Differences among local rice varieties in resistance to sulfur dioxide. *Report of special research project, NIES R-2.* p.135-144. (in Japanese) 1978.
10. Posthumus, A.C.: *Proc. Kupio meeting on plant damages caused by air pollution.* p.115-120, 1976.

## Inheritance of sensitivity to sulfur dioxide in rice, *Oryza sativa* L.

Takeshi Omura<sup>1</sup>, Hikaru Satoh<sup>1</sup>, Yasumi Fujinuma<sup>2</sup> and Ichiro Aiga<sup>2</sup>

<sup>1</sup> Laboratory of Plant Breeding, Faculty of Agriculture, Kyushu University, Fukuoka 812

<sup>2</sup> Division of Engineering, The National Institute for Environmental Studies, Yatabe, Ibaraki 305

A trial is described for the examination of the genetic characteristics of indicator plants for air pollutants using the cross procedure. In the present study, we crossed local rice varieties in Japan; LO 182 (female parent) with LO 271, 818, 1148 and 1181 (male parents). The female parent was SO<sub>2</sub>-sensitive but the male parents were SO<sub>2</sub>-resistant. From the cross experiments with LO 182 × LO 818 and LO 182 × LO 1181, we found that SO<sub>2</sub> sensitivity was governed by a pair of genes but there was no dominance. Also the SO<sub>2</sub> resistant character of LO 271 was controlled by a dominant gene.

**Key words:** Air pollution—Inheritance of sensitivity to SO<sub>2</sub>—Indicator plant—Plant breeding—Rice plant—Sulfur dioxide.

Sulfur dioxide, known as a major atmospheric pollutant, causes visible leaf damage to various plant species (3). To date, many results have been reported concerning the interspecific and/or intraspecific variation in resistance to SO<sub>2</sub> (1, 5). In the previous reports, we exposed some hundreds of rice varieties to SO<sub>2</sub> and found that the degree of visible damage was dependent on the rice varieties (2, 4). A few varieties were very sensitive to SO<sub>2</sub> although most of them were resistant. Among the sensitive varieties, 'Shinrikimochi' (LO 182) was found to be the most sensitive one to SO<sub>2</sub>. Hence, in the present work, we have tried to clarify the mode of inheritance for a physiological character of the sensitivity to SO<sub>2</sub> using the cross combination with LO 182.

### Materials and methods

The most SO<sub>2</sub>-sensitive variety of LO 182 (female parent) was crossed with LO 271, 818, 1148 and 1181 (male parents), which are SO<sub>2</sub>-resistant varieties (4). The F<sub>1</sub>'s were cultivated at Kyushu University. Seeds which harvested individually from each F<sub>1</sub> were supplied to determine the sensitivity to SO<sub>2</sub>. The sensitivity to SO<sub>2</sub> was investigated in F<sub>2</sub> seedlings. Seedlings were cultivated in the phytotron greenhouse situated in the National Institute for Environmental Studies at 27°C, 70%R.H. for 3 weeks. And they were exposed in the artificially lit fumigation cabinet to 2.0 ppm SO<sub>2</sub> for 6 hours. After exposure, the seedlings were allowed to stand for at least 24 hours in the fumigation cabinet without SO<sub>2</sub>. The degree of visible damage induced by exposure to SO<sub>2</sub> was determined by the method described elsewhere (2). The sensitivities to SO<sub>2</sub> were graded

by the degree of visible damage which appeared on the 4th and 5th leaves.

### Results and discussion

In the preliminary experiment, we exposed five parental varieties of  $F_1$  hybrids to 2.0 ppm  $SO_2$  for 8 and 12 hours (Table 1). Only one variety exhibited injury. Chlorotic symptoms were noted on the leaves of a female parent, LO 182, whereas little or no injury was found for the four male parents, i.e. LO 271, 818, 1148 and 1181.

The segregation modes in  $F_2$  are shown in Table 2. Although the parents were either resistant (-) or sensitive (++) , there appeared slightly sensitive-ones in the  $F_2$  of every cross combination. However, the segregation mode is different between the cross combinations. In the cross combination of LO 182  $\times$  LO 818 and LO 182  $\times$  LO 1181, the segregation mode into (++) , (+) and (-) coincides fairly well with the theoretical ratio of

Table 1  $SO_2$  sensitivity of parental varieties selected from local rice varieties in Japan.

Line No.	Variety name	$SO_2$ sensitivity
LO 182	Shinriki-mochi	++ (sensitive)
LO 271	Makitanichinko	- (resistant)
LO 818	Nankai - 24	- (resistant)
LO 1148	(unknown)	- (resistant)
LO 1181	(unknown)	- (resistant)

$SO_2$  exposure were done with 2.0 ppm for 8 and 12 hrs at 27°C, 70%R.H.

Table 2 Segregation of  $SO_2$  sensitivity in  $F_2$  of crosses between a  $SO_2$  sensitive variety of LO 182 and four  $SO_2$  resistant varieties of LO 271, 818, 1148 and 1181.

Cross combination	Female $\times$ Male	Segregation mode				$\chi^2$		P
		++	+	-	Total	(3:1)	(1:2:1)	
LO 182 $\times$ LO 271	(I)	18	18					
		36		164	200	5.226		0.025-0.010
	(II)	24	18					
		42		145	187	0.642		0.50 -0.25
	Total	42	36					
		78		309	387	4.844		0.05 -0.025
LO 182 $\times$ LO 818	(I)	50	100	50	200		0.000	> 0.995
	(II)	49	107	42	198		1.787	0.50 -0.25
	Total	99	107	92	398		0.888	0.75 -0.50
LO 182 $\times$ LO 1148	(I)	39	113	48	200		4.190	0.25 -0.10
	(II)	38	95	67	200		8.910	0.025-0.010
	Total	77	208	115	400		7.860	0.025-0.010
LO 182 $\times$ LO 1181	(I)	53	87	58	198		3.160	0.250-0.100
	(II)	39	98	60	197		4.418	0.250-0.100
	Total	92	185	118	395		5.005	0.100-0.050

Segregation mode indicates the degree of visible injury with  $SO_2$  2 ppm for 6 hrs at 27°C, 70%R.H.; (++) : sensitive, (+) : slightly sensitive and (-) : resistant.

## Inheritance of sensitivity to SO<sub>2</sub> in rice

1:2:1. This result may suggest that the SO<sub>2</sub>-sensitivity is governed by a pair of genes with no dominance.

On the other hand, the segregation mode in F<sub>2</sub> of LO 182 × LO 1148 is deviated from the theoretical ratio of 1:2:1. This observation may be resulted from an erroneous classification, because the degree of the sensitivity is rather continuous and there is no critical point between resistant (-) and slightly sensitive (+) or between (+) and (++).

The segregation mode in F<sub>2</sub> of LO 182 × LO 271 is quite different from that of the cross combinations mentioned above. Although slightly sensitive ones (+) were also segregated, their frequency is low, about the same as the sensitive ones (++) . About 3/4 of the total F<sub>2</sub> seedlings were resistant to SO<sub>2</sub>, showing no injury. Thus, we assume that the SO<sub>2</sub>-resistant character of LO 271 is controlled by a dominant gene.

At present, it is unclear whether this gene is allelic with the pair of genes mentioned above or not. The appearance of slightly sensitive seedlings (+) in this cross combination may be due to the participation of modifier decreasing SO<sub>2</sub> sensitivity. If we assume the participation of the modifier in the cross combination of LO 182 × LO 1148, the deviation of observed numbers from theoretical ones can be explained. With respect to these questions, genetical analysis should be continued in detail.

We thank Dr. A. Furukawa, Division of Environmental Biology, the N.I.E.S., for his critical reading of the manuscript.

### References

1. Agri., Forestry & Fishery Technology Council ed. Studies for circulation of polluted substances and biological indicators on agro, forest & aquatic ecosystems. *Report of Research*; 102. (in Japanese) 1977.
2. Fujinuma, Y. and I. Aiga. Selected rice (*Oryza sativa* L.) strains as an indicator plant for air pollution. *Res. Rep. Natl. Inst. Environ. Stud.*, No. 11, p.255-262. 1980.
3. Mudd, J. B. Sulfur dioxide. In: *Response of Plant to air pollution* (ed J. B. Mudd and T. T. Kozlowski), p.9-22. Academic Press 1975.
4. Omura, T., H. H. Satoh and K. Sugahara. Differences among local rice varieties in resistance to sulfur dioxide. *Report of special research project, NIES R-2*, p.135-144. (in Japanese) 1978.
5. Thomas, M. D. and Hendricks, R. H. Effect of air pollution on plant. In: *Air pollution handbook* (ed. P.L. Magill et al.), Cp. 9; p. 1-44. McGraw-Hill, New York 1956.

Studies on the Effects of  
Air Pollutants on Plants  
and  
Mechanisms of Phytotoxicity

RESEARCH REPORT FROM  
THE NATIONAL INSTITUTE FOR ENVIRONMENTAL STUDIES

No 11

国立公害研究所研究報告 第11号  
(R - 11, '80)

---

昭和55年2月29日発行

編集・発行 国立公害研究所

茨城県筑波郡谷田部町小野川16番2

---

印刷 勝美印刷株式会社  
東京都文京区小石川1-3-7

Published by the National Institute for Environmental Studies  
Yatabe-machi, Tsukuba, Ibaraki 305, Japan.

February 1980